

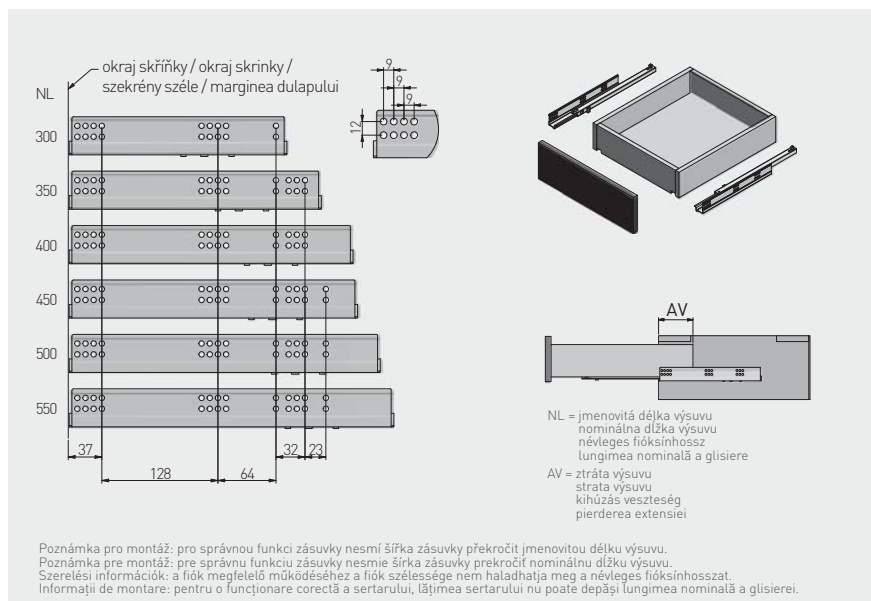







Skrytý výsuv s tlumením G10HX-H
 Skrytý výsuv s tlmením G10HX-H
 Rejtett fióksin, csillapított G10HX-H
 Glisiera sub sertar cu amortizare G10HX-H



		 L mm	 AV mm		 kg		
PB-G10HX300-H		300	83	částečný čistočný részleges parțial	25	pozinkovaný pozinkovaný galvanizált galvanizat	ocel ocel acél oțel
PB-G10HX350-H		350					
PB-G10HX450-H		450	111				
PB-G10HX500-H		500					
PB-G10HX550-H		550					

