

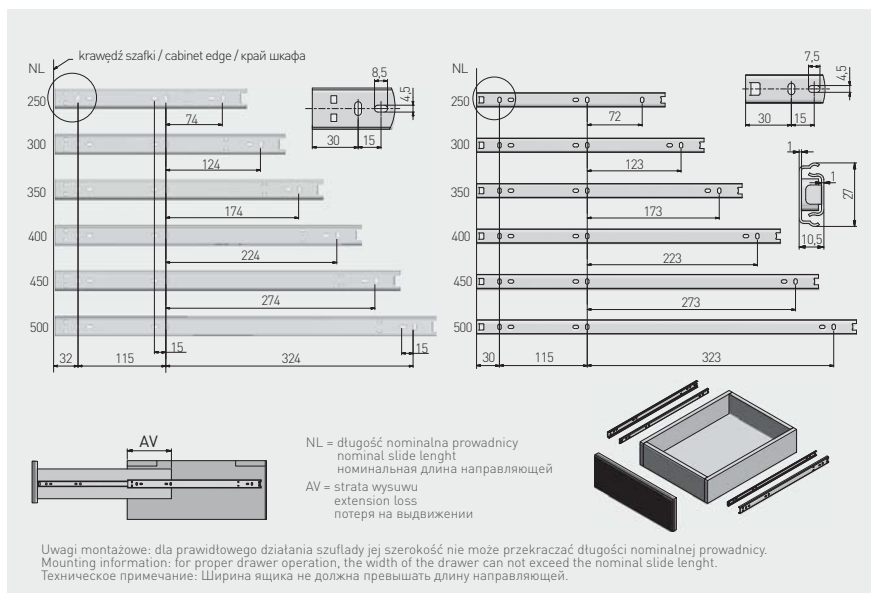







Prowadnica kulkowa H27
Ball bearing slide H27
Шариковая направляющая H27



		 L mm	 AV mm		 kg		
	PK-0H27-3000	300	109	niepełny partial неполное	15	ocynk galvanized гальваника	stal steel сталь
	PK-0H27-3500	350	124				
	PK-0H27-4000	400	134				
	PK-0H27-4500	450	149				
	PK-0H27-5000	500	184				

