

GTV



SUSTAV BEZ RUČKICA VELLO

VELLO

Trendovi minimalističkog uređenja prostora koji ne dominira već daje podršku u povratu u ravnotežu, aktualni su već nekoliko sezona. Izlazeći u susret sve većim potrebama, razvili smo sustav VELLO koji pruža mogućnost realizacije kuhinje u potpunosti bez ručkica.



VELLO je sustav vertikalnih i horizontalnih letvi dostupnih u četiri dizajna i četiri modne boje : bijela, crna, brušeni čelik i aluminij. Pomoću tih elemenata mogu se izgraditi ladice i ormari bez ručkica s ravnom linijom frontova namještaja.

Zahvaljujući horizontalnim letvama VELLO imamo mogućnost ugradnje rasvjete u svim ladicama i ormarićima koji se nalaze izravno ispod ovog profila. Zahvaljujući ovoj funkciji imamo u potpunosti osvijetljeni koristan prostor.

Vello letve montiraju se kako na unutarnjim bočnim elementima korpusa tako i na pregradnim elementima u kojima je potrebno rezanje. U dodatnoj varijanti moguće je rezanje i na bočnim panelima korpusa – u ovakvom slučaju preporučuju se estetski završeci. Izradjene od visokokvalitetnog aluminijskog Vello letve dostupne su u dužini od 3000 mm. Proizvod se može po želji rezati do bi se dobile izabrane dužine elemenata. Prilikom projektiranja kuhinje bez ručkica s ravnim linijama frontova ne smijemo zaboraviti o LED profilu prikladnom za ormare iznad radne ploče koji ima dvije funkcije - služi kao rasvjeta i kao nevidljiva ručkica. Nježna rasvjeta radne ploče ili sudopera je praktična dopuna kuhinjske opreme.









L profil horizontalni

Profil koji je montiran izravno ispod radne ploče a LED traka pruža mogućnost osvjetljenja unutrašnjosti ladica i ormarića koji se nalaze ispod profila .



Preporučeni pokrov:
PA-OSMLGLAXMIC3M-00N

profili

	 C mm	 L mm						
			aluminij	brušeni čelik	bijeli	crni mat	aluminij	12
za rezanje	3000	4100	PA-VELLO-L3M-05	PA-VELLO-L3M-06	PA-VELLO-L3M-10	PA-VELLO-L3M-20M		
			PA-VELLO-L4M-05	PA-VELLO-L4M-06	PA-VELLO-L4M-10	PA-VELLO-L4M-20M		

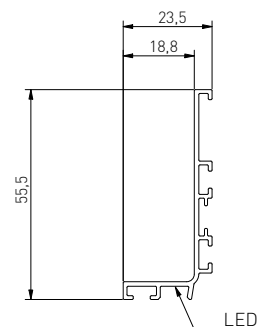



Horizontalni C profil

Profil koji se idealno uklapa u poziciji između dviju ladica, pruža mogućnost otvaranja ladica kako odozgo tako i odozdo. Zahvaljujući LED funkciji rasvjeta unutar ladice koja se nalazi ispod profila.



Preporučeni pokrov:
PA-OSMLGLAXMIC3M-00N

profili

	C mm	L mm					
			aluminij	brušeni čelik	bijeli	crni mat	
za rezanje	3000	4100	PA-VELLO-C3M-05	PA-VELLO-C3M-06	PA-VELLO-C3M-10	PA-VELLO-C3M-20M	aluminij
			PA-VELLO-C4M-05	PA-VELLO-C4M-06	PA-VELLO-C4M-10	PA-VELLO-C4M-20M	12

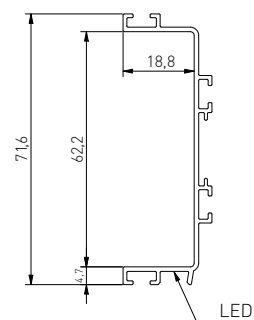



T- profil vertikalni, pojedinačni

Profil namijenjen za otvaranje bez ručkica ormarića tip cargo. Za otvaranje pojedinačnih ormara.



profili

C mm	L mm						
		aluminij	brušeni čelik	bijeli	crni mat	aluminij	8
za rezanje	3000	PA-VELLO-TJ3M-05	PA-VELLO-TJ3M-06	PA-VELLO-TJ3M-10	PA-VELLO-TJ3M-20M		

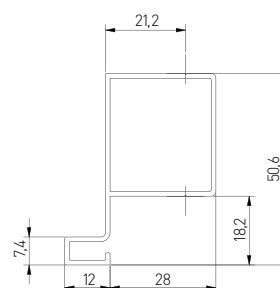

T profil vertikalni, dvostruki

Profil služi za otvaranje ormarića tip cargo bez ručkice. Zahvaljujući dvostrukoj konstrukciji mogu se otvarati dva neovisna ormarića.



profili



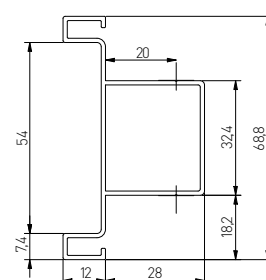



C mm	L mm						
		aluminij	brušeni čelik	bijeli	crni mat	aluminij	8
za rezanje	3000	PA-VELLO-TD3M-05	PA-VELLO-TD3M-06	PA-VELLO-TD3M-10	PA-VELLO-TD3M-20M		



Rasvjeta u profilima L i C



U profilima C i L prikladna je LED traka širine 5 mm iz ponude GTV (indeksi dolje). Za traku treba odabrati mikro poklopac u mliječnoj boji PA-OSMLGLAXM-00 dužine od 3 m.

			
LD-2835-600-5MM-20-ZB	12 VDC 6,6 Wm	750 lm/m	 6500 K
LD-2835-600-5MM-20-NE4			 4000 K
LD-2835-600-5MM-20-CB			 3200 K

Dopunski proizvodi – prekidači:



AE-WBBUNI-10DIM



AE-WBCUNI-10DIM



AE-WBEZDB-10S



AE-WBEZDC-10S

Na donjem crtežu prikazana je mogućnost montiranja profila na stijenke korpusa bez potrebe montiranja završetaka. Ovo je varijanta za osobe koje cijene homogenu površinu namještaja.

PA-VELLO-L3M

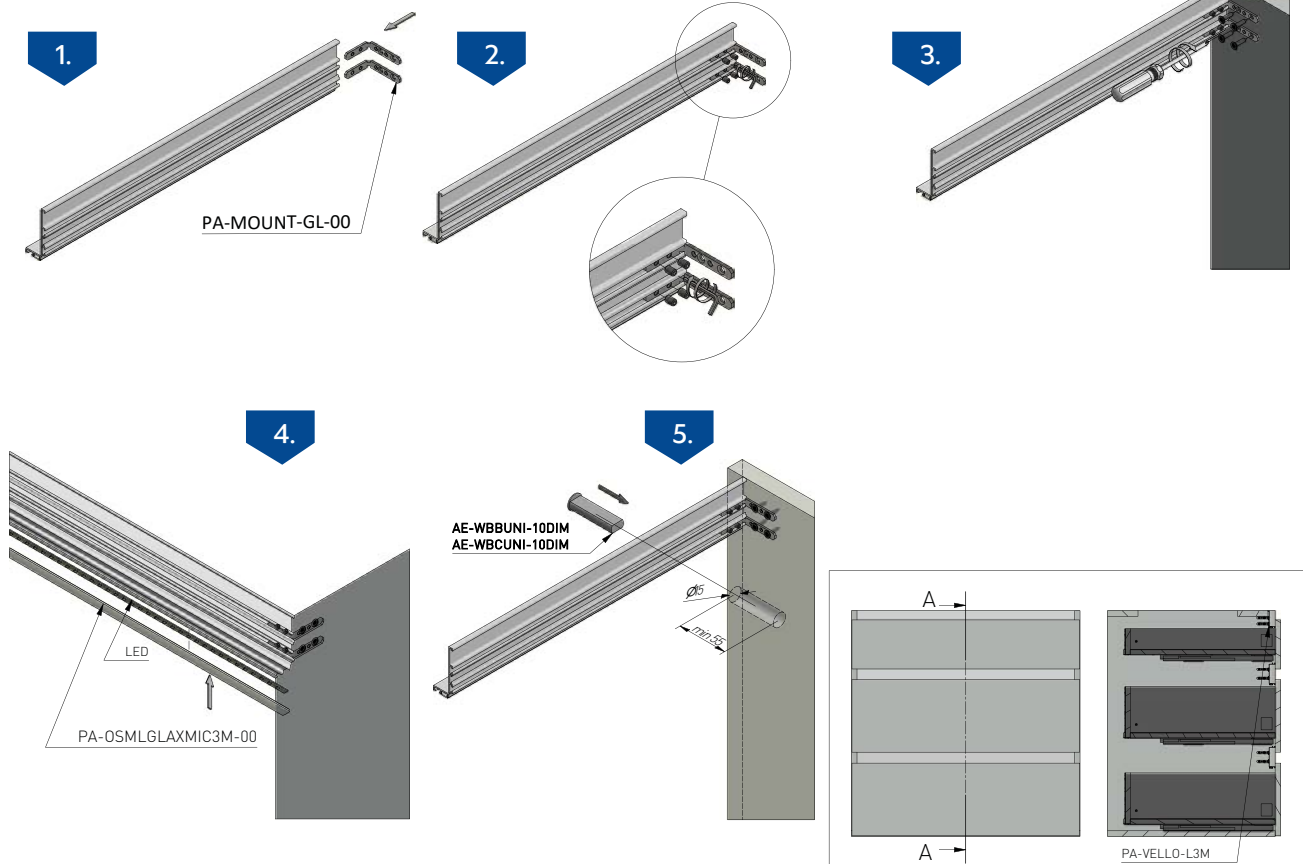

PA-VELLO-C3M

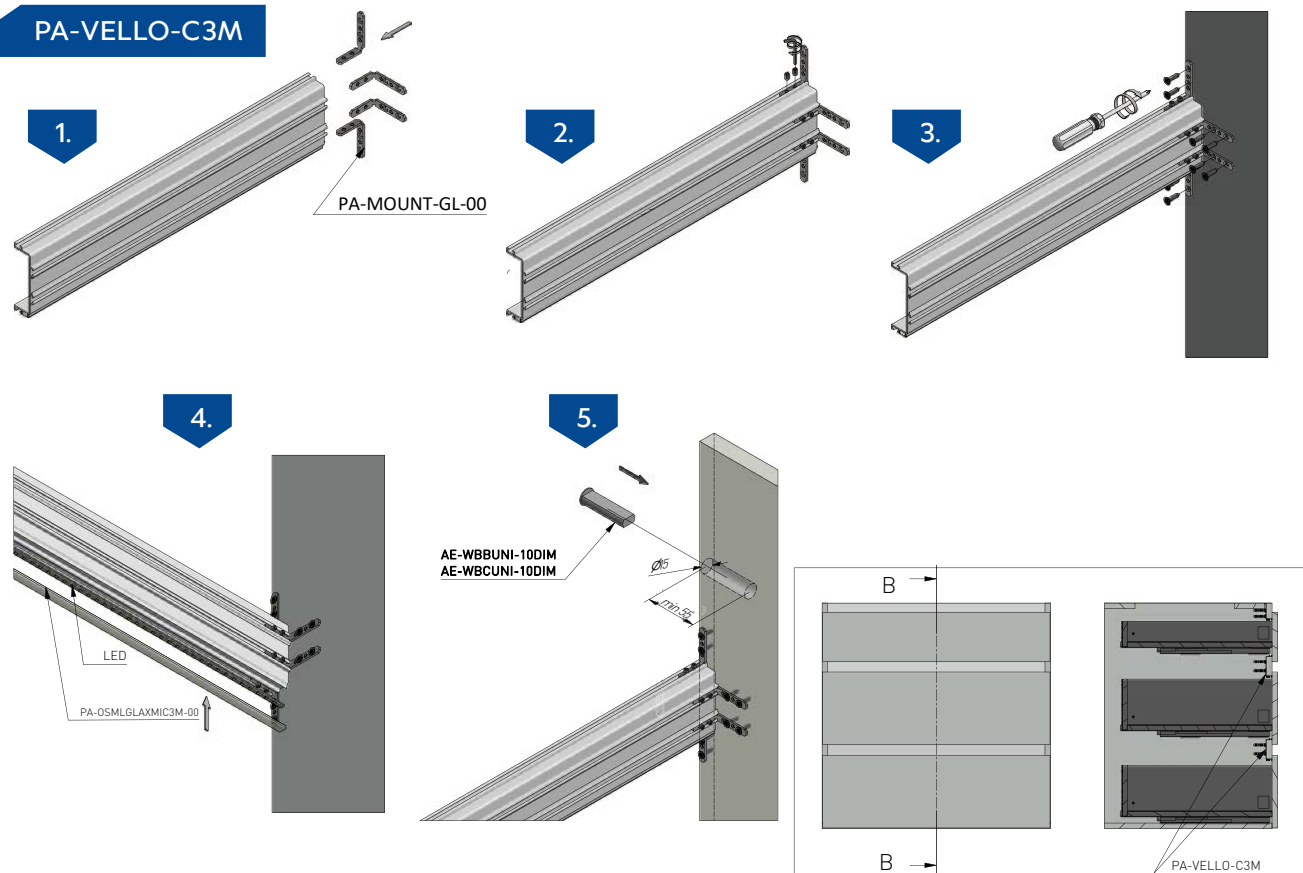

Pričvrсни elementi sustava Vello



PA-MOUNT-GL-00

Pričvrсни element pruža mogućnost montaže horizontalnih letvi M C i L kako unutar stjenki korpusa kao i na pregradama. Pričvrсни element može istovremeno služiti za spajanje dva profila kao i za pregrade. Pričvrсни element istovremeno može služiti za pravokutno horizontalno spajanje dva profila.

Set se sastoji od 2 konektora i 8 vijaka M4 (4 vijka za svako učvršćivanje). Dvije upuštene rupe služe montiranju ručke s pomoću vijaka na ploču korpusa elementa (nisu uključeni). Pakiranje - 50 setova (po 2 kom.) u jednom pakiranju.

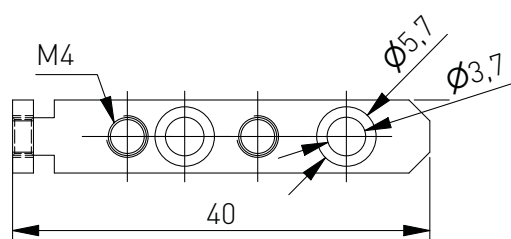
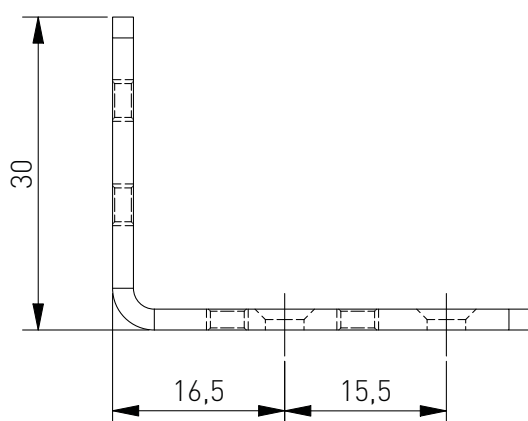







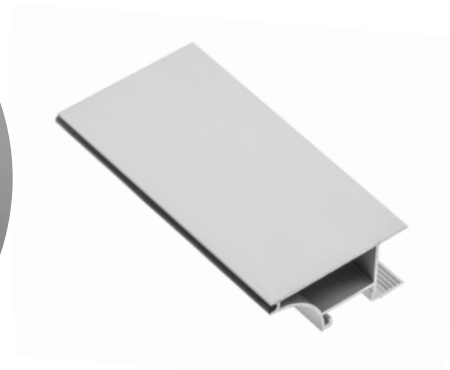
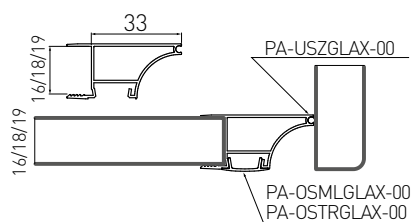

Profil za LED

Ravnu liniju ormara moguće je postići montirajući na donjem robu GLAX profil – ovo je rješenje dva u jednom – zamjenjuje ručkicu i istovremeno luži kao osvjetljenje radne ploče.



						
PA-GLAXWN-AL	18	2	profil	srebrni	aluminij	
PA-GLAXWN3M-AL		3		crni		
PA-GLAXWN3M-AL-20M				bijeli		
PA-GLAXWN3M-AL-10				inox		
PA-GLAXWN3M-AL-06						
PA-OSMLGLAX-00	-	2	kućište	mlječni	PC	
PA-OSTRGLAX-00		3		transparentan		
PA-OSMLGLAX3M-00	-			mlječni		
PA-OSTRGLAX3M-00	-	transparentan				
PA-USZGLAX-00N	-	10	brtva	crni	EPDM	
PA-USZGLAX-10N	-			bijeli		

Za profil se može se koristiti bilo koja traka GTV Lighting s poklopcem.

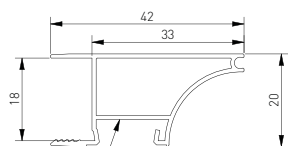
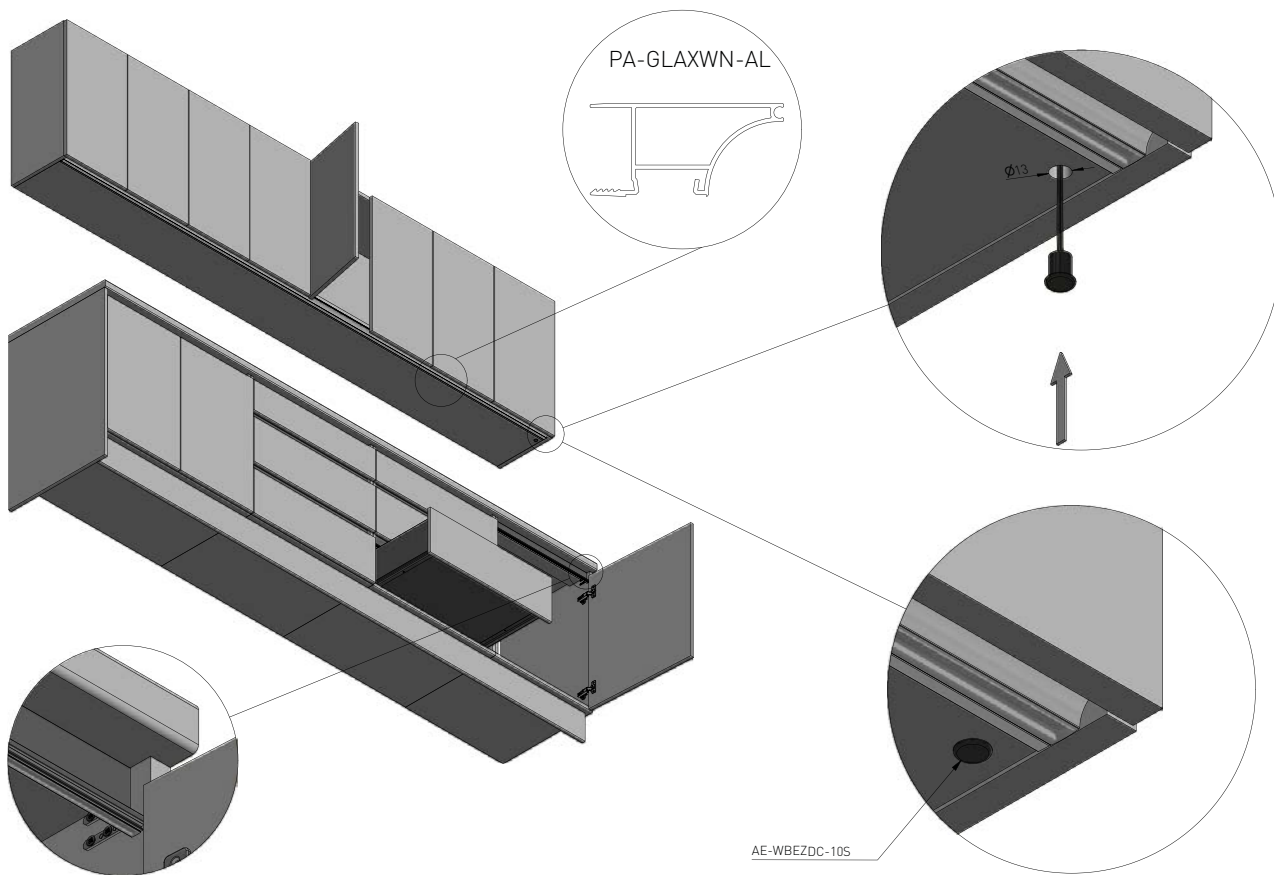

Površina za lijepljenje LED

PA-GLAXWN-AL	Profil Glax, dužina 2 m, srebrni
PA-GLAXWN3M-05	Profil Glax, dužina 3 m, srebrni
PA-GLAXWN3M-20M	Profil Glax dužina 3m, crni
PA-GLAXWN3M-10	Profil Glax dužina 3m, bijeli
PA-GLAXWN3M-06	Profil Glax dužina 3m, inox

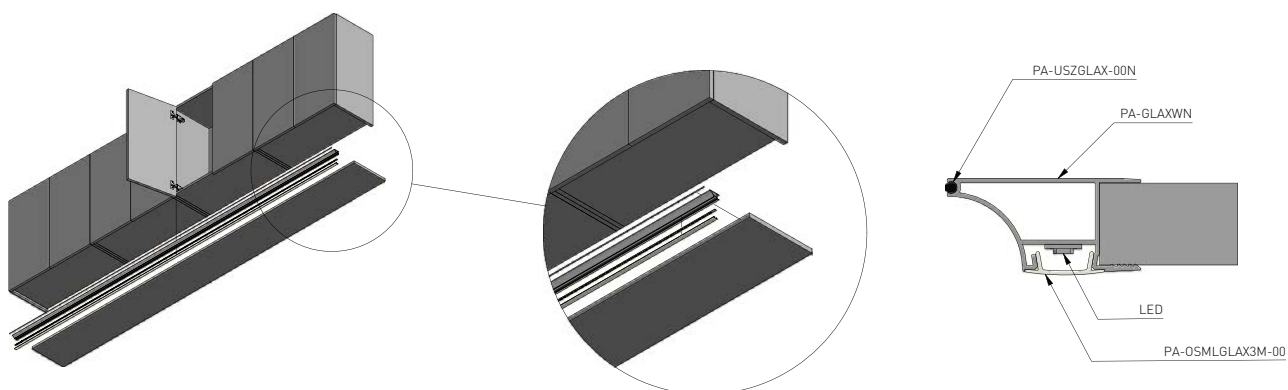

Završeci za Vello sustav

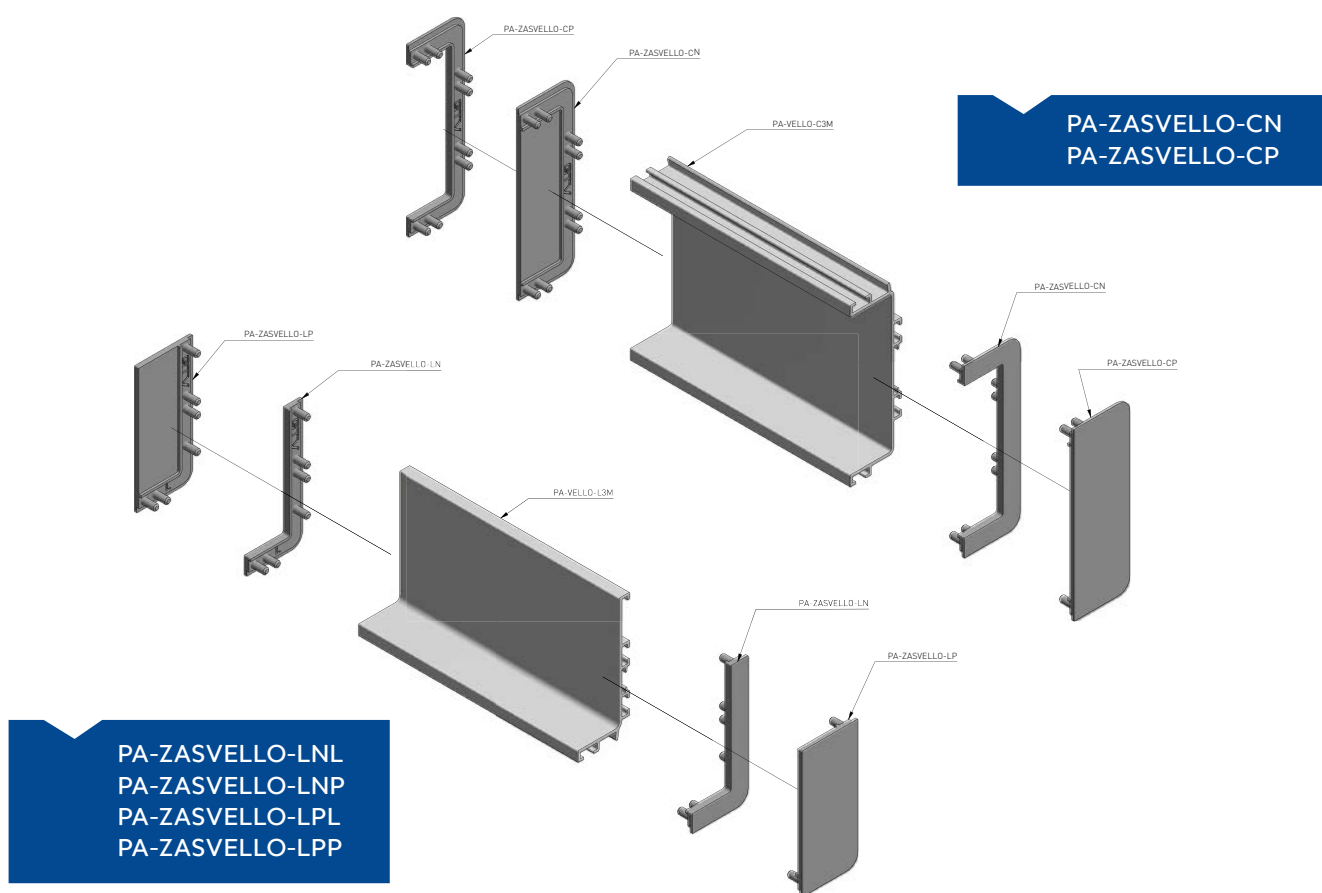

Završetke za profile proizvodimo u tehnologiji 3D ispisa, koji su nakon toga lakirani u boji profila. U slučaju L profila imamo lijevi i desni završetak u punoj ili nepotpunoj izvedbi. Završetak za C profil je simetričan, u punoj i nepotpunoj izvedbi.

Svaku vrstu završetka za profil nudimo u četiri različite boje da bi se završetak podudarao s profilom.

Završne kape za L profil

						
aluminij	brušeni čelik	bijeli	crni mat	materijal	10	
PA-ZASVELLO-LNL-05	PA-ZASVELLO-LNL-06	PA-ZASVELLO-LNL-10	PA-ZASVELLO-LNL-20M			
PA-ZASVELLO-LNP-05	PA-ZASVELLO-LNP-06	PA-ZASVELLO-LNP-10	PA-ZASVELLO-LNP-20M			
PA-ZASVELLO-LPL-05	PA-ZASVELLO-LPL-06	PA-ZASVELLO-LPL-10	PA-ZASVELLO-LPL-20M			
PA-ZASVELLO-LPP-05	PA-ZASVELLO-LPP-06	PA-ZASVELLO-LPP-10	PA-ZASVELLO-LPP-20M			

Završne kape za C profil

						
aluminij	brušeni čelik	bijeli	crni mat	materijal	10	
PA-ZASVELLO-CN-05	PA-ZASVELLO-CN-06	PA-ZASVELLO-CN-10	PA-ZASVELLO-CN-20M			
PA-ZASVELLO-CP-05	PA-ZASVELLO-CP-06	PA-ZASVELLO-CP-10	PA-ZASVELLO-CP-20M			

Rezanje bočnih elemenata pod završetke

OPCIJA - Rezanje + završne kape

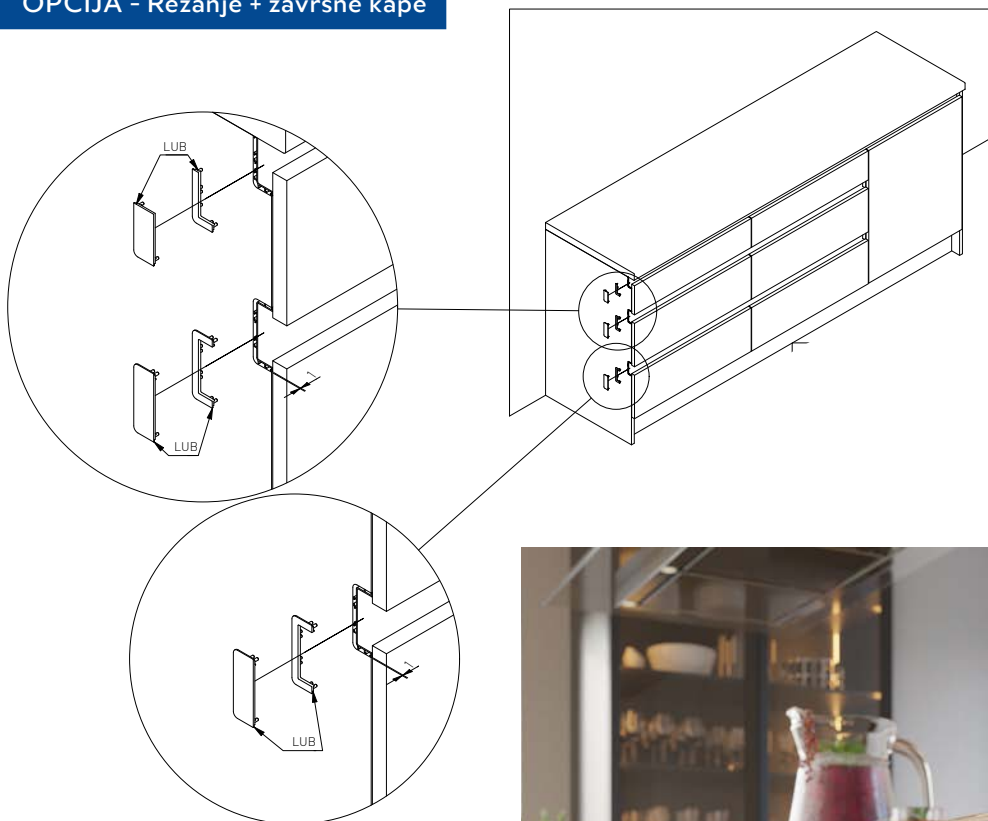

Dimenzije rezova

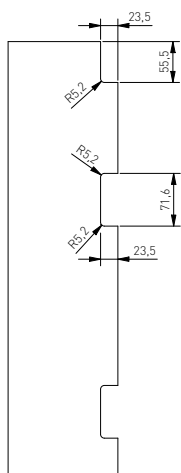







Vello sustav prikladan je za sve vrste kuhinjskog prostora - kako za male tako i za velike kuhinje. Savršeno je rješenje za loft i industrijalni stil kuhinja, s tamnim frontovima. Izvrsno se uklapa i u sve nijanse modne sive boje - od svijetlo sive sve do boje antracita. Klasična bijela kuhinja s radnom pločom u nijansi toplog drveta isto tako je izmičljeno mjesto za primjenu Vello sustava. Sustav je u tolikoj mjeri univerzalan da praktično ne postoje za njega nikakva ograničenja VELLO je sustav vertikalnih i horizontalnih letvi dostupnih u četiri dizajna i četiri modne boje: bijela, crna, brušeni čelik i aluminij. Pomoću tih elemenata mogu se izgraditi ladice i ormari bez ručkica s ravnom linijom frontova namještaja.

Minimalizam u interijerima - iako su ova dizajnerska rješenja odavno prisutna - još uvijek može iznenaditi. Još uvijek možemo otkriti nove načine kako pojednostaviti prostor, a da ne izgubimo njegovu čar. Ascetični interijer ne znači da mora biti skroman i dosadan. Vrlo je jednostavno stvoriti pomoću Vello sustava i LED profila moderan, udoban i funkcionalni interijer, koji se odlikuje suptilnom estetikom.

VELLO





Druga, u istoj mjeri originalna vrsta letva za kuhinje su rubni profili iz naše ponude: U, J i C2. Izrađeni od aluminija, dužine i 3500 m za rezanje, savršeni kao „nevidljive” ručkice .

Ručkica PROFIL C2

 C mm	 L mm		
za rezanje	3500	aluminij PA-0241-35-50	aluminij





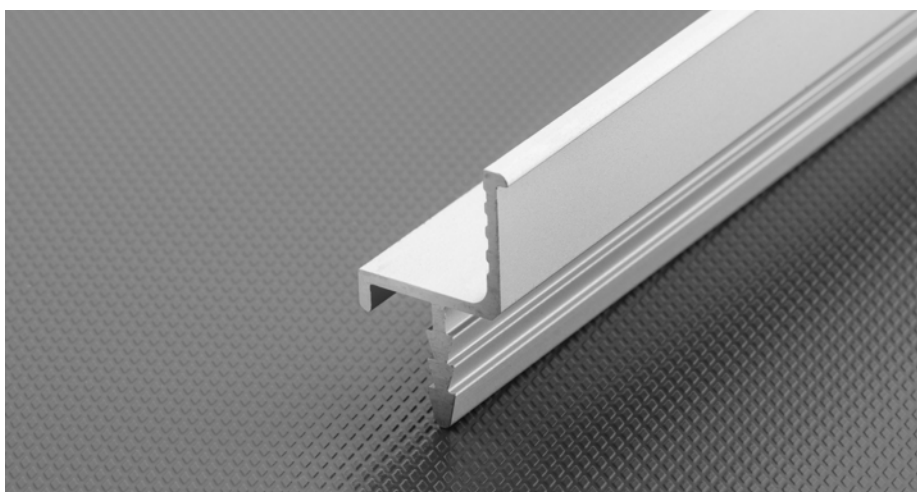

Ručkica PROFIL J

 C mm	 L mm		
za rezanje	3500	aluminij PA-0245-35-50	aluminij



Ručkica PROFIL U

 C mm	 L mm		
za rezanje	3500	aluminij PA-0244-35-50	aluminij



Vello

MOLIMO SKANIRAJTE KOD
i vidite kako može izgledati kuhinja s Vello sustavom



GTV

ul. Przejazdowa 21
05-800 Pruszków
Poland

tel.: + 48 22 44 47 272
fax: + 48 22 444 75 01
e-mail: info@gtv.com.pl



gtv.com.pl