



# Schubladeneinsatz AXISPACE

Verfügbar ab April

Für Schubladen mit einer Breite von 400, 500, 600, 800 und 900 mm

Farben : weiß und anthrazit

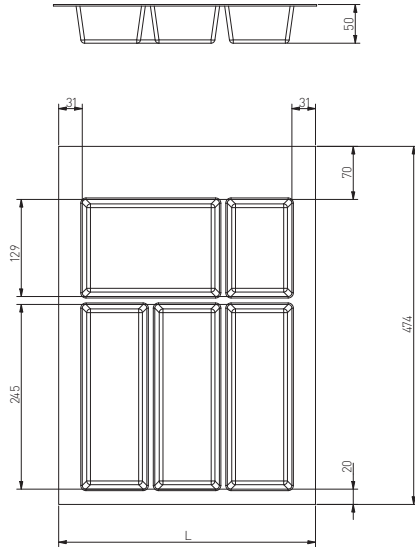

	 L mm		
WK-SZ-AS-400-10	340	weiß	Kunststoff
WK-SZ-AS-500-10	440		
WK-SZ-AS-600-10	540		
WK-SZ-AS-800-10	740		
WK-SZ-AS-900-10	840		
WK-SZ-AS-400-60	340	anthrazit	
WK-SZ-AS-500-60	440		
WK-SZ-AS-600-60	540		
WK-SZ-AS-800-60	740		
WK-SZ-AS-900-60	840		

# Ausziehbares Cargo-Regal, Organizer für Schrank MOVIX PRO

Verfügbar ab Mai

Antirutschmatte

Mit Kugelführungen mit Dämpfung

Vertikale und horizontale Einstellung

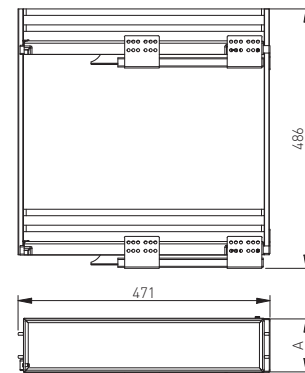

	 A mm			
KO-200B0-60	200	145	verzinkt	Stahl
KO-150B0-60	150	114		
KO-200B0-01	200	145		
KO-150B0-01	150	114		

\* Führungen nicht im Lieferumfang enthalten  
Kompatibel mit Soft Close Führungen PB-K0450B0-L1 und PB-K0450B0-R1



➤ Vollständige Synchronisation der einzelnen Elemente

➤ Hochwertige Qualität, zertifizierte Lebensdauer von 60.000 Zyklen

➤ 3D Regulierung und Soft-Close-Funktion

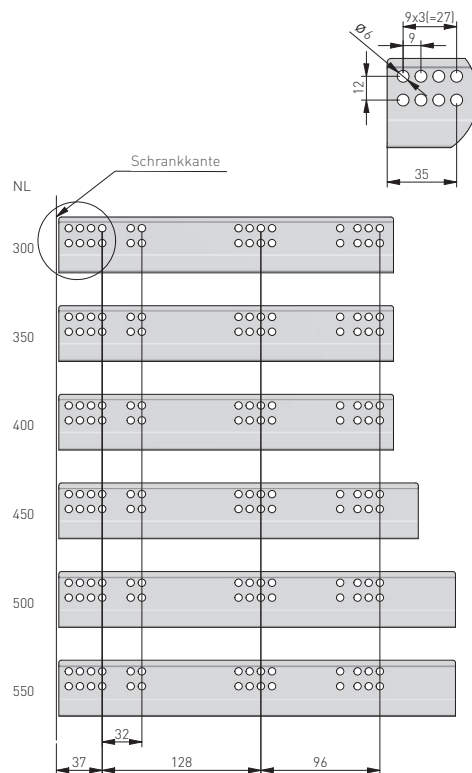

NL mm		AV mm
300	PB-3D0SHX18-300-PRO	-
350	PB-3D0SHX18-350-PRO	-
400	PB-3D0SHX18-400-PRO	-
450	PB-3D0SHX18-450-PRO	-
500	PB-3D0SHX18-500-PRO	-
550	PB-3D0SHX18-550-PRO	-





# Tischbein ARTO - hairpin





Jetzt verfügbar

Die perfekte Basis zur Erstellung von Tischen und Couchtischen die im Loft-Stil gehalten sind

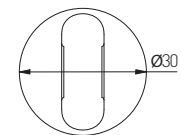
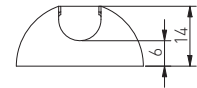
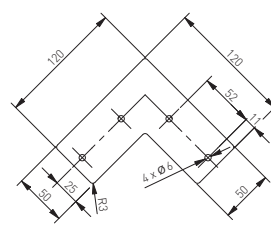
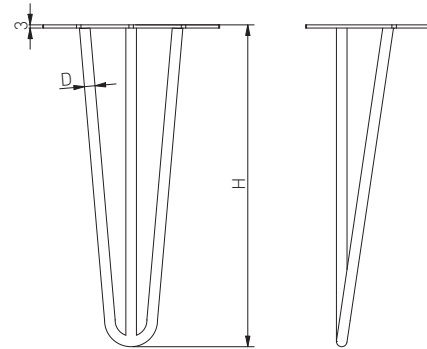
Erhältlich in drei Größen in den Varianten mit zwei oder drei Stangen

Kommt mit einer weichen Kunststoffkappe



		 H mm	$\varnothing D$ (mm)			
NM-ARTO-10-3R304-20M		304	ø10	schwarz matt	Stahl, Kunststoff	4
NM-ARTO-10-3R406-20M		406				
NM-ARTO-10-3R711-20M		711				
NM-ARTO-12-3R304-20M		304	ø12			
NM-ARTO-12-3R406-20M		406				
NM-ARTO-12-3R711-20M		711				

# Tischbein ARTO - hairpin





Jetzt verfügbar

Die perfekte Basis zur Erstellung von Tischen und Couchtischen die im Loft-Stil gehalten sind

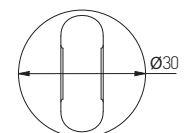
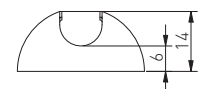
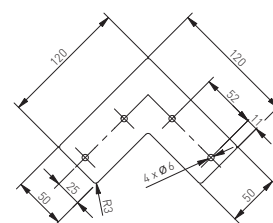
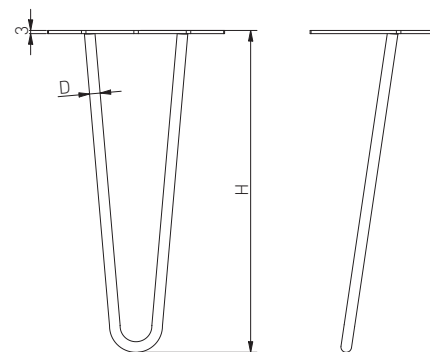
Erhältlich in drei Größen in den Varianten mit zwei oder drei Stangen

Kommt mit einer weichen Kunststoffkappe



		 H mm	$\varnothing D$ (mm)			
NM-ARTO-10-2R304-20M		304	ø10	schwarz matt	Stahl, Kunststoff	4
NM-ARTO-10-2R406-20M		406				
NM-ARTO-10-2R711-20M		711				
NM-ARTO-12-2R304-20M		304	ø12			
NM-ARTO-12-2R406-20M		406				
NM-ARTO-12-2R711-20M		711				







Eine große Auswahl an Modellen bietet die Möglichkeit vieler interessanter Arrangements

Es sorgt für einen stabilen Sitz der Tischplatte

Einfache Montage - die Tischgestelle passen perfekt zum DIY-Trend

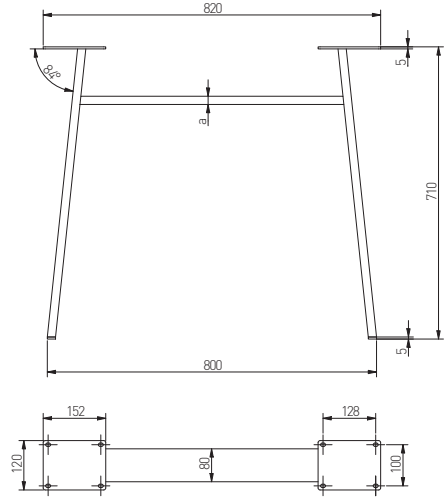

		a (mm)		
NM-INDUSTRIA-H20-710X820-20M	schwarz matt	20	Stahl	1
NM-INDUSTRIA-H40-710X820-20M		40		

Eine große Auswahl an Modellen bietet die Möglichkeit vieler interessanter Arrangements

Es sorgt für einen stabilen Sitz der Tischplatte

Einfache Montage - die Tischgestelle passen perfekt zum DIY-Trend

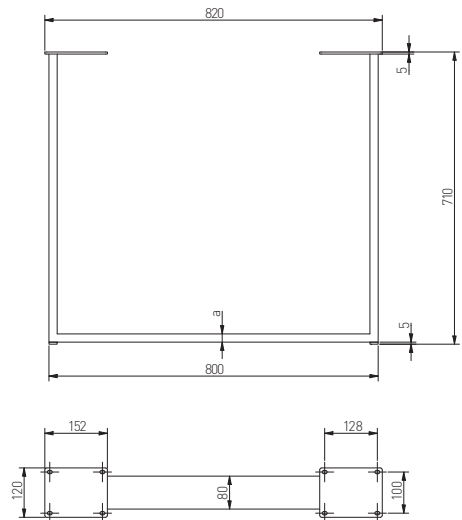

		a (mm)		
NM-INDUSTRIA-P20-710X820-20M	schwarz matt	20	Stahl	1
NM-INDUSTRIA-P40-710X820-20M		40		
NM-INDUSTRIA-P80-710X820-20M		80		







Eine große Auswahl an Modellen bietet die Möglichkeit vieler interessanter Arrangements

Es sorgt für einen stabilen Sitz der Tischplatte

Einfache Montage - die Tischgestelle passen perfekt zum DIY-Trend

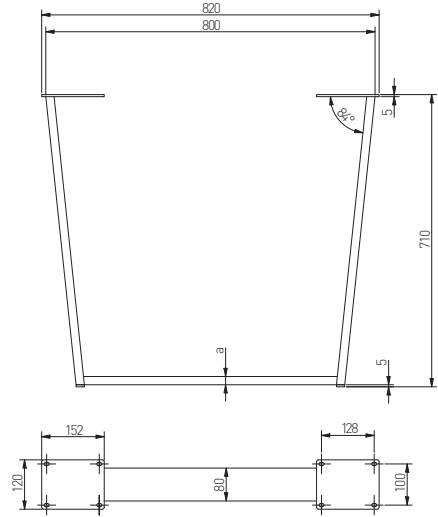

			a (mm)		
NM-INDUSTRIA-T20-710X820-20M		schwarz matt	20	Stahl	1
NM-INDUSTRIA-T40-710X820-20M			40		

Eine große Auswahl an Modellen bietet die Möglichkeit vieler interessanter Arrangements

Es sorgt für einen stabilen Sitz der Tischplatte

Einfache Montage - die Tischgestelle passen perfekt zum DIY-Trend

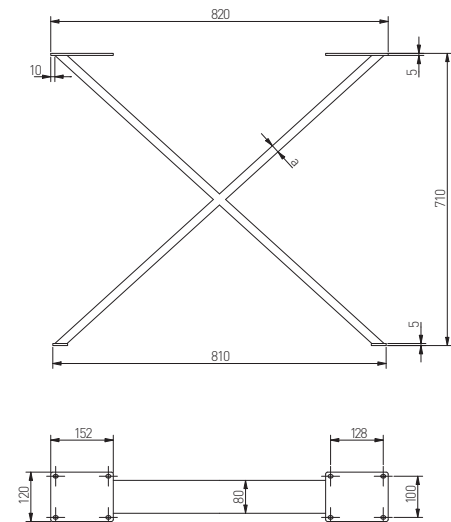

			a (mm)		
NM-INDUSTRIA-X20-710X820-20M		schwarz matt	20	Stahl	1
NM-INDUSTRIA-X40-710X820-20M			40		
NM-INDUSTRIA-X80-710X820-20M			80		



- Passt perfekt zum Trend minimalistischer Innenräume
- Durch horizontale Leisten müssen keine Griffe mehr montiert werden
- Möglichkeit der Verwendung von LED-Beleuchtung

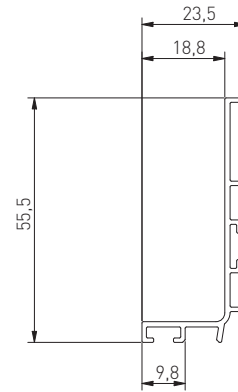

C mm	L mm					↓	
		aluminium	edelstahloptik	weiß	schwarz matt	12.	Aluminium
Zum Zuschneiden	3000	PA-VELLO-L3M-05	PA-VELLO-L3M-06	PA-VELLO-L3M-10	PA-VELLO-L3M-20M		

Zubehör



PA-ZASVELLO-LNL-20M



PA-ZASVELLO-LNP-20M



PA-ZASVELLO-LPL-20M



PA-ZASVELLO-LPP-20M



PA-MOUNT-GL-00

Abdeckung



PA-OSMLGLAXMIC3M-00N

				↓	
aluminium	edelstahloptik	weiß	schwarz matt	10.	Kunststoff
PA-ZASVELLO-LNL-05	PA-ZASVELLO-LNL-06	PA-ZASVELLO-LNL-10	PA-ZASVELLO-LNL-20M		
PA-ZASVELLO-LNP-05	PA-ZASVELLO-LNP-06	PA-ZASVELLO-LNP-10	PA-ZASVELLO-LNP-20M		
PA-ZASVELLO-LPL-05	PA-ZASVELLO-LPL-06	PA-ZASVELLO-LPL-10	PA-ZASVELLO-LPL-20M		
PA-ZASVELLO-LPP-05	PA-ZASVELLO-LPP-06	PA-ZASVELLO-LPP-10	PA-ZASVELLO-LPP-20M		

Möglichkeit des Einsatzes der LED-Beleuchtung. Empfohlen wird die Abdeckung PA-OSMLGLAXMIC3M-00N.

		↓	
aluminium	PA-MOUNT-GL-00	50	Stahl





- ▶ Passt perfekt zum Trend minimalistischer Innenräume
- ▶ Durch horizontale Leisten müssen keine Griffe mehr montiert werden
- ▶ Möglichkeit der Verwendung von LED-Beleuchtung

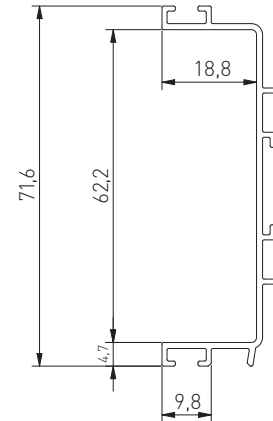

C mm	L mm						
		aluminium	edelstahloptik	weiß	schwarz matt	12	Aluminium
Zum Zuschneiden	3000	PA-VELLO-C3M-05	PA-VELLO-C3M-06	PA-VELLO-C3M-10	PA-VELLO-C3M-20M		

Zubehör

Abdeckung



PA-ZASVELLO-CN-20M



PA-ZASVELO-CP-20M



PA-MOUNT-GL-00



PA-OSMLGLAXMIC3M-00N

aluminium	edelstahloptik	weiß	schwarz matt	10	Kunststoff
PA-ZASVELLO-CN-05	PA-ZASVELLO-CN-06	PA-ZASVELLO-CN-10	PA-ZASVELLO-CN-20M		
PA-ZASVELLO-CP-05	PA-ZASVELLO-CP-06	PA-ZASVELO-CP-10	PA-ZASVELO-CP-20M		

Möglichkeit des Einsatzes der LED-Beleuchtung. Empfohlen wird die Abdeckung PA-OSMLGLAXMIC3M-00N.

aluminium	50	Stahl	
PA-MOUNT-GL-00			







# Griffloses System VELLO

Verfügbar ab April

➤ Passt perfekt zum Trend minimalistischer Innenräume

➤ Durch vertikalen Leisten müssen keine Griffe mehr montiert werden

➤ Eignen sich ideal für hohe Küchenschränke

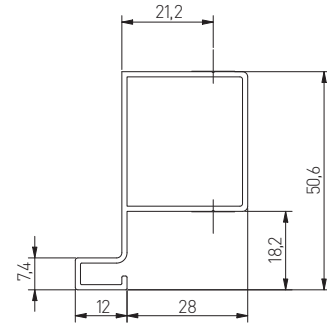

C mm	L mm						
		aluminium	edelstahloptik	weiß	schwarz matt	12	Aluminium
Zum Zuschneiden	3000	PA-VELLO-TJ3M-05	PA-VELLO-TJ3M-06	PA-VELLO-TJ3M-10	PA-VELLO-TJ3M-20M		

# Griffloses System VELLO

Verfügbar ab April

➤ Passt perfekt zum Trend minimalistischer Innenräume

➤ Durch vertikalen Leisten müssen keine Griffe mehr montiert werden

➤ Eignen sich ideal für hohe Küchenschränke

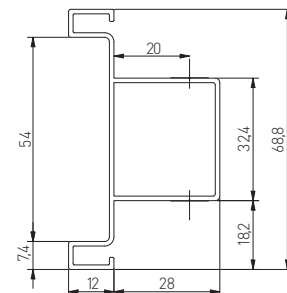

C mm	L mm						
		aluminium	edelstahloptik	weiß	schwarz matt	12	Aluminium
Zum Zuschneiden	3000	PA-VELLO-TD3M-05	PA-VELLO-TD3M-06	PA-VELLO-TD3M-10	PA-VELLO-TD3M-20M		

# Griff UZ-133

Verfügbar ab Juni

Durch das einfache Design eignet sich der Griff sowohl für Küchen- als auch für Büromöbel

Das klassische schwarz matt verleiht dem Innenraum Eleganz

Neue Farbe



C mm	L mm			
		schwarz matt	25	ZnAl
128	135	UZ-133128-20M		

# Griff UZ-G1

Verfügbar ab Juni

Durch das einfache Design eignet sich der Griff sowohl für Küchen- als auch für Büromöbel

Das klassische schwarz matt verleiht dem Innenraum Eleganz

Neue Farbe

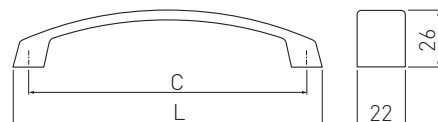

C mm	L mm			
		schwarz matt	20	ZnAl
128	142	UZ-G1-128-20M		
160	174	UZ-G1-160-20M		
192	206	UZ-G1-192-20M		
256	270	UZ-G1-256-20M		
320	334	UZ-G1-320-20M		

## Griff UZ-G2

Verfügbar ab Juni

Ein subtiler, einfacher Griff mit einer zarten Linie

Das klassische schwarz matt verleiht dem Innenraum Eleganz

Neue Farbe

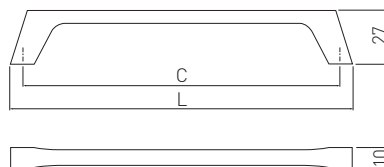

C mm	L mm			
		schwarz matt	25	ZnAl
160	172	UZ-G2-160-20M		
224	236	UZ-G2-224-20M		

## Griff UZ-Z10

Verfügbar ab Juni

Zarter, dünner Griff in subtiler Form

Das klassische schwarz matt verleiht dem Innenraum Eleganz

Neue Farbe

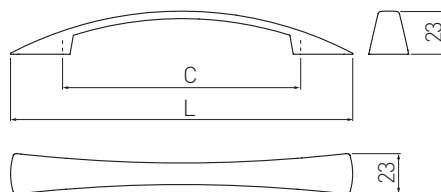

C mm	L mm			
		schwarz matt	50	ZnAl
96	138	UZ-Z10096-20M		
128	184	UZ-Z10128-20M		



# Griff CAPRI

Verfügbar ab Juni

Klassisches Design für viele Arrangements

Schwarz matt verleiht dem Innenraum Eleganz

Neue Farbe

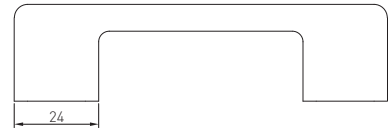
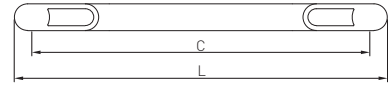

C mm	L mm			
C	L	schwarz matt		
128	138	UZ-CAPRI-128-20M	25	ZnAl
160	170	UZ-CAPRI-160-20M		
192	202	UZ-CAPRI-192-20M		
256	266	UZ-CAPRI-256-20M		

# Griff GENUA

Verfügbar ab Juni

Perfekt für Büro- und Wohnzimmermöbel

Das klassische schwarz matt verleiht dem Innenraum Eleganz

Neue Farbe

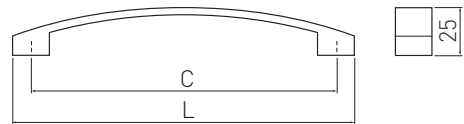

C mm	L mm			
		schwarz matt		
128	148	UZ-GENUA128-20M	40	ZnAl
160	180	UZ-GENUA160-20M	35	

# Griff UZ-40

Verfügbar ab Juni

Ein geometrischer, einfacher Möbelknauf, der mit jeder Schublade funktioniert

Das klassische schwarz matt verleiht dem Innenraum Eleganz

Neue Farbe

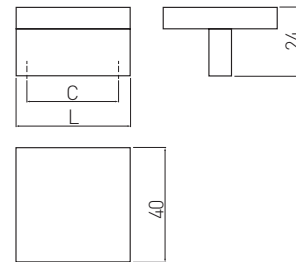

C mm	L mm			
		schwarz matt	50	ZnAl
32	40	UZ-40-032-20M		

# Griff LIND

Verfügbar ab Juni

Der Kantengriff fügt sich subtil in die Vorderseite der Möbel ein

Das klassische schwarz matt verleiht dem Innenraum Eleganz

Neues Design

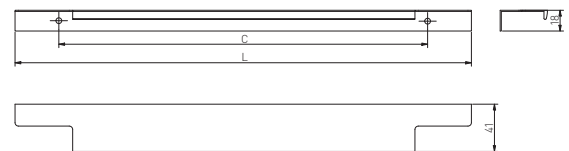

C mm	L mm						
		chrom	aluminium	gold gebürstet	schwarz matt	25	Aluminium
256	296	UA-LIND-256-296-01	UA-LIND-256-296-05	UA-LIND-256-296-18	UA-LIND-256-296-20M		
320	396	UA-LIND-320-396-01	UA-LIND-320-396-05	UA-LIND-320-396-18	UA-LIND-320-396-20M		
224	496*	UA-LIND-224-496-01	UA-LIND-224-496-05	UA-LIND-224-496-18	UA-LIND-224-496-20M		
256	596	UA-LIND-256-596-01	UA-LIND-256-596-05	UA-LIND-256-596-18	UA-LIND-256-596-20M		
352	796	UA-LIND-352-796-01	UA-LIND-352-796-05	UA-LIND-352-796-18	UA-LIND-352-796-20M		

\* Mocowanie na 3 wkręty

# Griff VITO

Verfügbar ab Juni

Schlanker Griff mit künstlerischem Design

Das klassische schwarz matt verleiht dem Innenraum Eleganz

Neue Farbe

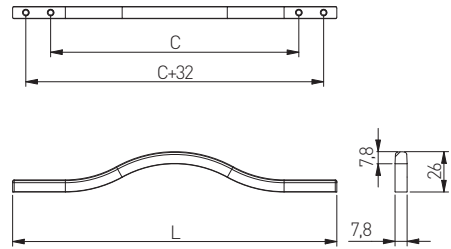

C mm	L mm			
		gold messing		
160	210	UZ-VITO-160-16	25	ZnAl
288	340	UZ-VITO-288-16		

# Griff VENICE

Verfügbar ab Juni

Modernes Design für minimalistisches Interieur

Das klassische schwarz matt verleiht dem Innenraum Eleganz

Neues Design

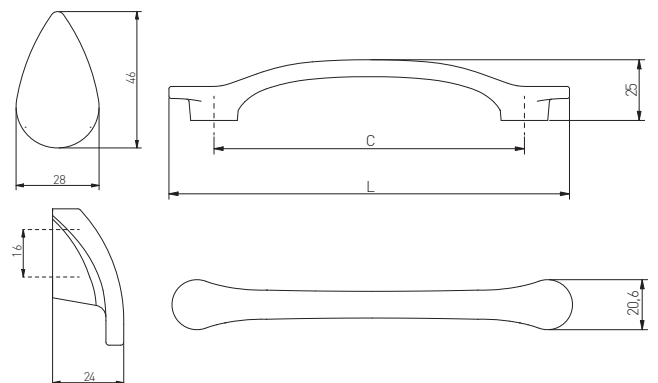

C mm	L mm				
C	L	champagner	schwarz matt		
128	165	UZ-VENICE-128-90	UZ-VENICE-128-20M	20	ZnAl
gatka		GZ-VENICE-1-90	GZ-VENICE-1-20M		

# Griff OTTO

Verfügbar ab Juni

Ein moderner, einfacher Griff, der zu jeder Front passt

Das klassische schwarz matt verleiht dem Innenraum Eleganz

Neues Design

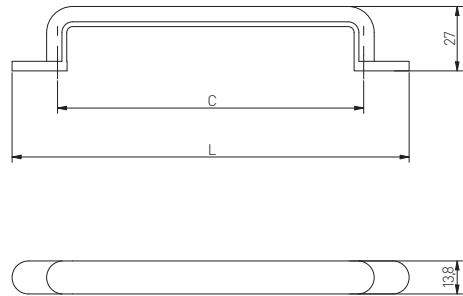

C mm	L mm					
		edelstahloptik	champagner	schwarz matt	20	ZnAl
128	166	UZ-OTTO-128-06	UZ-OTTO-128-90	UZ-OTTO-128-20M		
160	198	UZ-OTTO-160-06	UZ-OTTO-160-90	UZ-OTTO-160-20M		

# Griff EVER

Verfügbar ab Juni

Originelles Design, perfekt für klassische und Retro-Interieurs

Das klassische schwarz matt verleiht dem Innenraum Eleganz

Neues Design

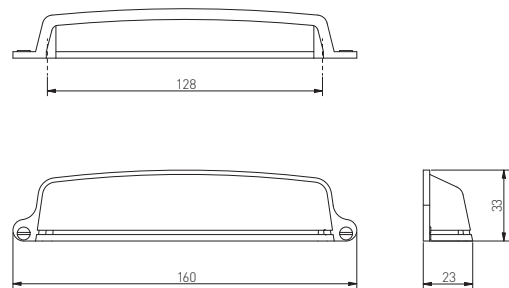

C mm	L mm					
		champagner	schwarz matt	20	ZnAl	
128	160	UZ-EVER-128-90	UZ-EVER-128-20M			

Minimalistisches, modernes Design

Das klassische schwarz matt verleiht dem Innenraum Eleganz

Neues Design

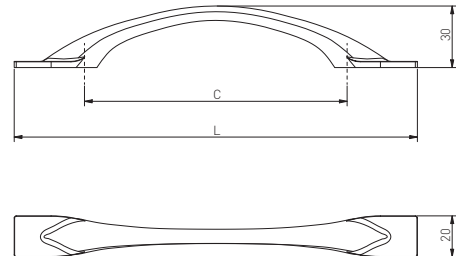

C mm	L mm	edelstahloptik	champagner	schwarz matt		
128	200	UZ-FLOW-128-06	UZ-FLOW-128-90	UZ-FLOW-128-20M	25	ZnAl
192	270	UZ-FLOW-192-06	UZ-FLOW-192-90	UZ-FLOW-192-20M	30	

Minimalistisches, modernes Design

Das klassische schwarz matt verleiht dem Innenraum Eleganz

Neues Design

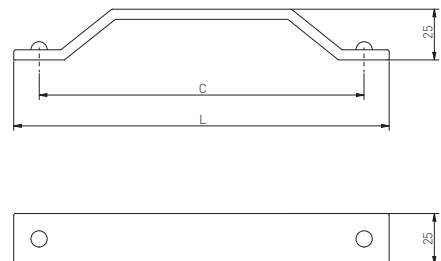

C mm	L mm	altsilber	schwarz matt		
160	185	UZ-STEP-160-07	UZ-STEP-160-20M	25	ZnAl



# Griff RETRIS

Verfügbar ab Juni

Klassischer Griff für Interieurs im Retro- und Loft-Stil

Schwarz matt verleiht dem Innenraum Eleganz

Neues Design

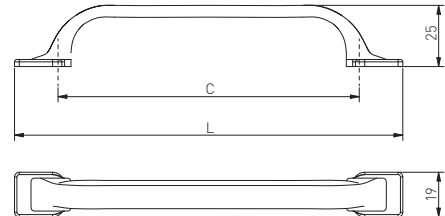

C mm	L mm					
		altmessing	altsilber	schwarz matt	25	ZnAl
128	165	UZ-RETRIS-128-04	UZ-RETRIS-128-07	UZ-RETRIS-128-20M		

# Griff HEXI

Verfügbar ab Juni

Der Kantengriff fügt sich subtil in die Vorderseite der Möbel ein

Verfügbar auch in schwarz, Länge 3500 mm zum selbst Zuschneiden

Neue Farbe

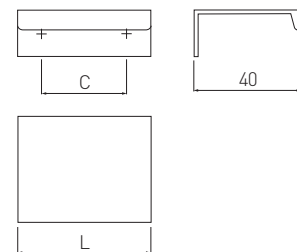
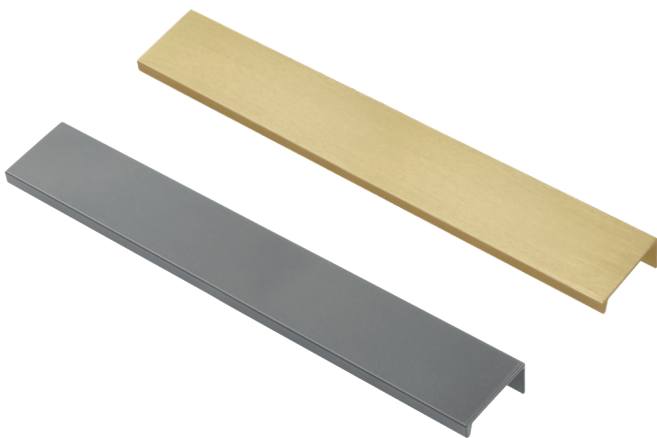

C mm	L mm				
		anthrazit	gold gebürstet	schwarz matt	Aluminium
32	50	UA-HEXI-60	UA-HEXI-18	-	
96	150	UA-HEXI96-60	UA-HEXI96-18	-	
192	225	UA-HEXI192-60	UA-HEXI192-18	-	
do cięcia	3500	-	-	UA-HEXI-3500-20M	

Der Kantengriff fügt sich subtil in die Vorderseite der Möbel ein

Das klassische schwarz matt verleiht dem Innenraum Eleganz

Neue Farbe

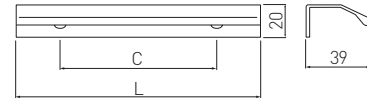

 C mm	 L mm			
do cięcia	3500	schwarz matt UA-TREX-3500-20M	24	Aluminium



# LED-Streifen FLASH

Verfügbar ab Juni

Die gängigste Lichtfarbe: neutral



LD-5050-300-20-NE4	12 VDC, 14,4 W/m	900 lm/m	● 4000 K	65	120°	10	60/m	5
LD-5050-300-65-NE4		850 lm/m	● 4000 K					
LD-5630-300-20-NE4	12 VDC, 16 W/m	1750 lm/m	● 4000 K	20		8	120/m	2,5
LD-3528-600-20-NE4	12 VDC, 9,6 W/m	550 lm/m	● 4000 K					
LD-3528-600-65-NE4		520 lm/m	● 4000 K					
LD-3528-300-65-NE4	12 VDC, 4,8 W/m	280 lm/m	● 4000 K	65			60/m	5
LD-2835-600-65-NE4	12 VDC, 12 W/m	1350 lm/m	● 4000 K			10	120/m	2,5
LD-RGBW-300-20	12 VDC, 17 W/m	-	● RGBW	20		10	60/m	5



# LED-Streifen FLASH

Verfügbar ab Juni

Die gängigste Lichtfarbe: neutral



LD-3528-600-20-ZB-50	12DC, 9,6W/m	550 lm/m	● 6500 K	20	120°	8 mm	120/m	2,5
LD-3528-600-20-CB-50			● 4000 K					
LD-3528-600-20-NE4-50			● 3200 K					
LD-5050-300-20-NE4-50	12DC, 14,4W/m	900 lm/m	● 4000 K			10 mm	60/m	5
LD-5630-300-20-NE4-50	12DC, 16W/m	1750 lm/m	● 4000 K					





- Ein sehr flexibles Band, mit dem Sie komplexe Formen erstellen können
- Aus natürlichem Silikon hergestellt - IP65
- Halterungen und Endkappen im Set



Icon: Folder	Icon: Watt	Icon: Sun	Icon: Three Circles	Icon: IP	Icon: Bend	Icon: Dimension mm	Icon: Magnifying Glass	Icon: Scissors
LD-NF12V6x12-65-ZB	12 VDC, 8 W/m	200 lm/m	● 6500 K	IP65	120°	6 mm	100/m	2,5
LD-NF12V6x12-65-NE			● 4000 K					
LD-NF12V6x12-65-CB			● 3200 K					

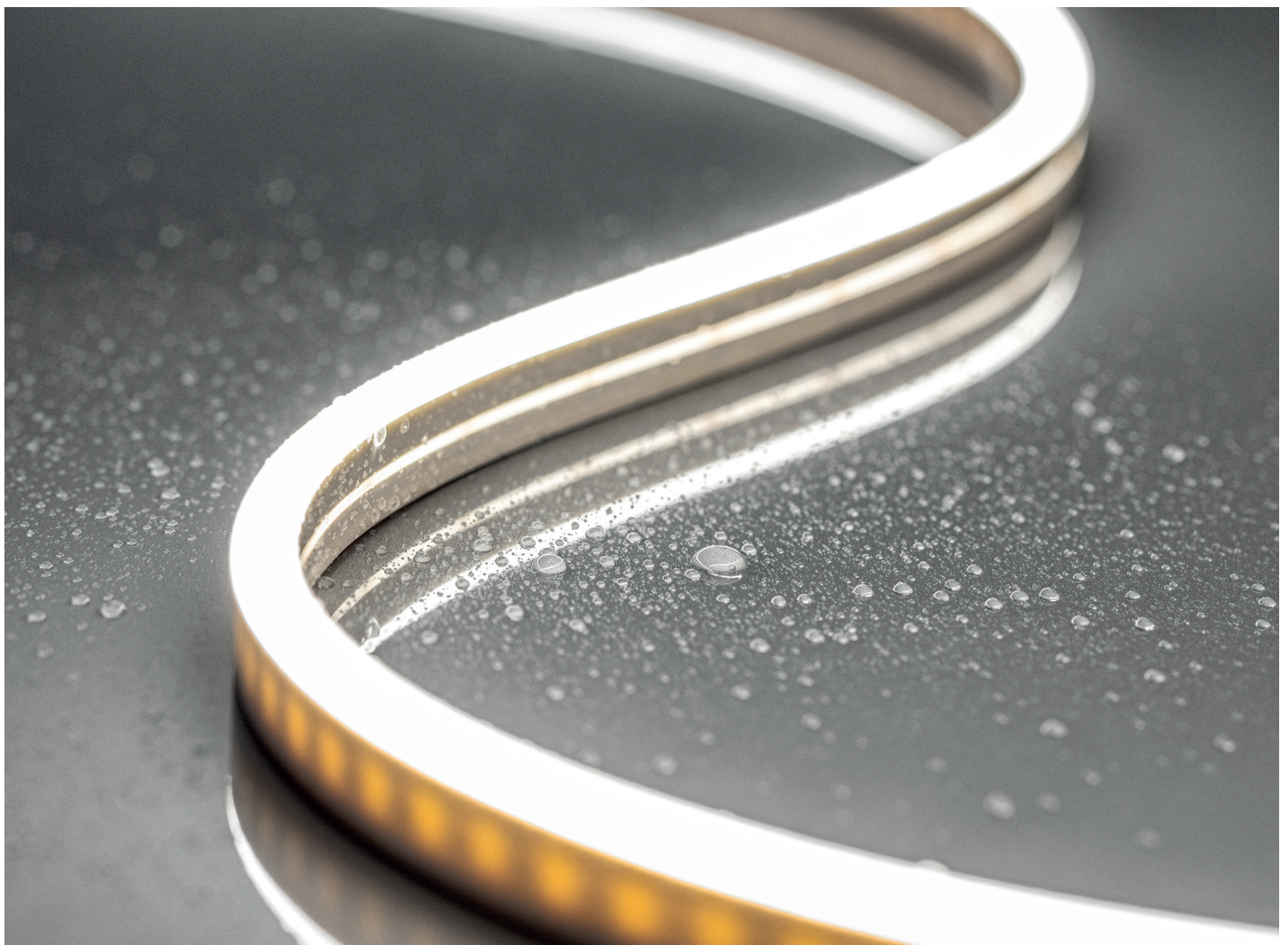



4 in 1, vier LEDs in einer (zusätzliche weiße Farbe)

60 LEDs/m

Set zum sofortigen Anschließen: Streifen, Netzteil, Controller

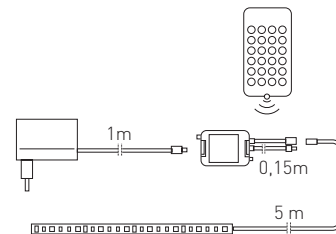

LD-ZLRGBW-300-20

12V

RGBW

Kunststoff

10

5



## LED-Streifen COB

Neueste Technologie basierend auf COB-LEDs

Gleichmäßige Lichtlinie

Hohe Lichtergibigkeit bei geringem Stromverbrauch



LD-COB12V-20-ZB

LD-COB12V-20-NE

LD-COB12V-20-CB

12 VDC, 8 W/m

830 lm/m

800 lm/m

750 lm/m

6500 K

4000 K

3200 K

20

180°

8 mm

320/m

5









Stromversorgung mit eingebauten MiniAMP-Buchsen, schneller Anschluss des LED-Streifens

Reduzierte Größe des Gehäuses

Integriertes Netzkabel

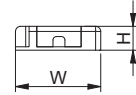
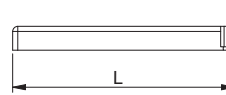

Modell	max	i	A	LxWxH mm	Kunststoff	g
LD-ZAS09WEC-30	9 W	3 miniAMP	0,75 A	103 x 41 x 12mm	Kunststoff	110 g
LD-ZAS15WEC-30	15 W	4 miniAMP	1,25 A	129 x 42 x 16 mm		130 g
LD-ZAS20WEC-30	20 W		1,67 A	129 x 42 x 16 mm		140 g
LD-ZAS30WEC-30	30 W	6 miniAMP	2,5 A	160 x 50 x 18 mm		190 g
LD-ZAS60WEC-30	60 W		5 A	190 x 62 x 21 mm		290 g



## Schrankunterbodenprofil GLAX

Jetzt verfügbar

Erweiterung des Angebots um 3-Meter-Profile

Neue Farben: Inox, Weiß und Schwarz

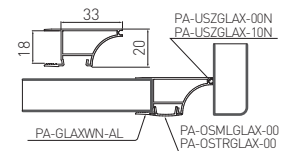

Modell	BOARD mm	L m	Farbe	Material
PA-GLAXWN3M-AL	18	3	silberfarben	Aluminium
PA-GLAXWN3M-AL-20M			schwarz	
PA-GLAXWN3M-AL-10			weiß	
PA-GLAXWN3M-AL-06			inox	



ul. Przejazdowa 21  
05-800 Pruszków  
Poland

 +48 22 44 47 272

 +48 22 44 47 366  
+48 22 44 47 331

 +48 22 44 47 391

 + 48 22 44 47 379

 + 420 591 160 091

 +48 22 444 73 24

 +48 22 444 73 07

 +375 291 504 626

 +48 22 44 47 523

 +48 22 44 47 524

 +48 735 201 464

 +48 22 4447 525

 +48 22 44 47 297

 +48 539 770 636

 ООО «ГТВ РУС»  
140073 Московская область  
город Люберцы, рабочий поселок Томилино  
мкрн. Птицефабрика, Литер 7А

 GTV Croatia d.o.o  
Kovinska 4a, 10000 Zagreb  
Hrvatska  
+ 385 1 798 8089

 GTV Czech Distribution s.r.o.  
CTPark Ostrava, Na Rovince 879  
720 00 Ostrava-Hrabová  
Česká republika  
+420 591 160 092  
+420 727 800 362  
+420 725 715 142

 GTV España Herrajes e Iluminación,  
S.L., Avenida Aragón 30, Planta 8  
46021 Valencia (España)  
+ 34 961 134 441  
+ 34 960 468 666  
+ 48 22 444 73 77

fax: +48 22 444 75 01

e-mail: [info@gtv.com.pl](mailto:info@gtv.com.pl)

[www.gtv.com.pl](http://www.gtv.com.pl)

