



Range-couverts AXISPACE

Disponible à partir d'avril

Pour tiroir de largeur 400, 500, 600, 800 i 900 mm

Couleurs: blanc et anthracite

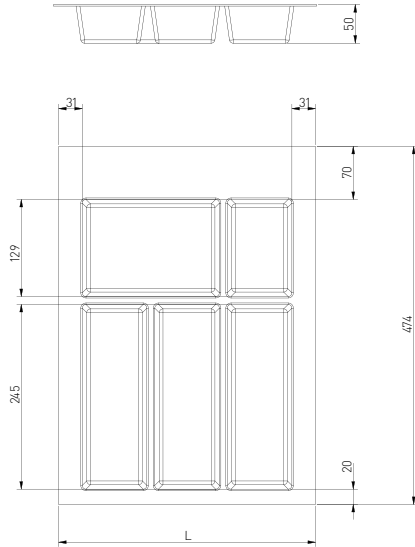

Code	L mm	Couleur	Matériau
WK-SZ-AS-400-10	340	blanc	plastique
WK-SZ-AS-500-10	440		
WK-SZ-AS-600-10	540		
WK-SZ-AS-800-10	740		
WK-SZ-AS-900-10	840		
WK-SZ-AS-400-60	340	anthracite	
WK-SZ-AS-500-60	440		
WK-SZ-AS-600-60	540		
WK-SZ-AS-800-60	740		
WK-SZ-AS-900-60	840		

Panier latéral MOVIX PRO

Disponible à partir d'avril

Tapis antidérapant

Sur glissière à billes avec fonction de fermeture amortie

Réglage vertical et horizontal

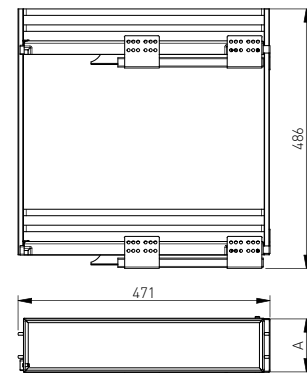

Code	mm	A	Matériau	Couleur
KO-200B0-60	200	145	galvanisé	anthracite
KO-150B0-60	150	114		
KO-200B0-01	200	145		chrome
KO-150B0-01	150	114		

* Le produit ne comprend pas de coulisses.
Produit supplémentaire: coulisses à soft close PB-KO450B0-L1 et PB-KO450B0-R1

Synchronisation complète des composants

Classe premium, curée de vie certifiée - 60000 cycles

Reglage 3D et fermeture silencieuse

SGS

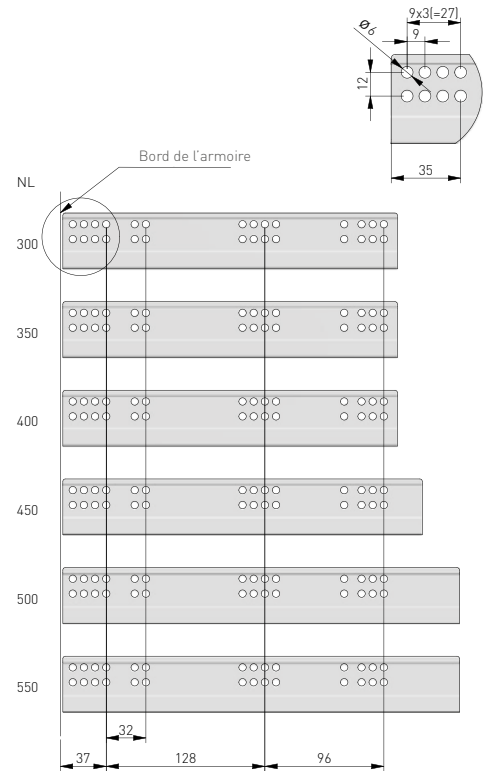

NL mm		AV mm
300	PB-3D0SHX18-300-PRO	-
350	PB-3D0SHX18-350-PRO	-
400	PB-3D0SHX18-400-PRO	-
450	PB-3D0SHX18-450-PRO	-
500	PB-3D0SHX18-500-PRO	-
550	PB-3D0SHX18-550-PRO	-



Pied ARTO - type hairpin





Disponible maintenant

Base idéale pour créer des tables et de petites tables loft

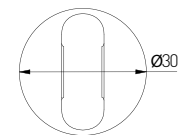
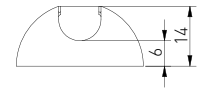
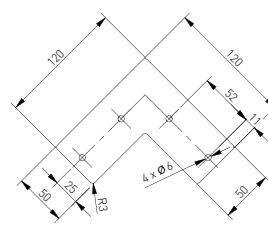
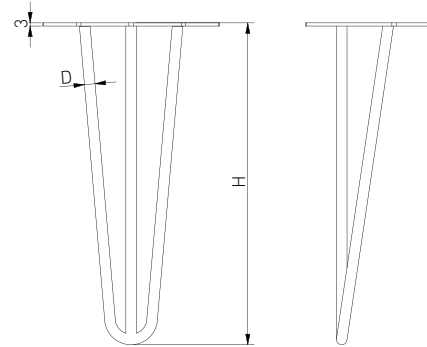
Variante disponible avec deux ou trois barres et en trois dimensions

Équipé de protège-pieds



		 H mm	$\varnothing D$ (mm)			
NM-ARTO-10-3R304-20M		304	Ø10	noir mat	acier, plastique	4
NM-ARTO-10-3R406-20M		406				
NM-ARTO-10-3R711-20M		711				
NM-ARTO-12-3R304-20M		304	Ø12			
NM-ARTO-12-3R406-20M		406				
NM-ARTO-12-3R711-20M		711				

Pied ARTO - type hairpin





Disponible maintenant

La base idéale pour créer des tables et de petites tables de loft

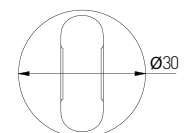
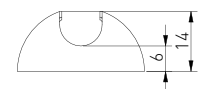
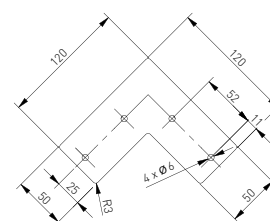
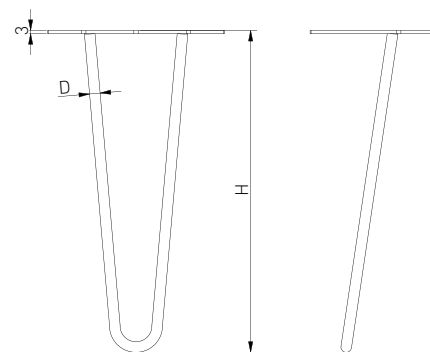
Disponible avec deux et trois épingles à cheveux et en trois hauteurs

Équipé de protège-pieds



		 H mm	$\varnothing D$ (mm)			
NM-ARTO-10-2R304-20M		304	Ø10	noir mat	acier, plastique	4
NM-ARTO-10-2R406-20M		406				
NM-ARTO-10-2R711-20M		711				
NM-ARTO-12-2R304-20M		304	Ø12			
NM-ARTO-12-2R406-20M		406				
NM-ARTO-12-2R711-20M		711				



Pied de table en bois massif INDUSTRIA

Disponible maintenant

Une grande variété de designs offre la possibilité de nombreux arrangements

Il assure une solidité et une stabilité à votre plateau

Assemblage facile - pieds de table style industriel s'intègrent parfaitement dans la tendance DIY

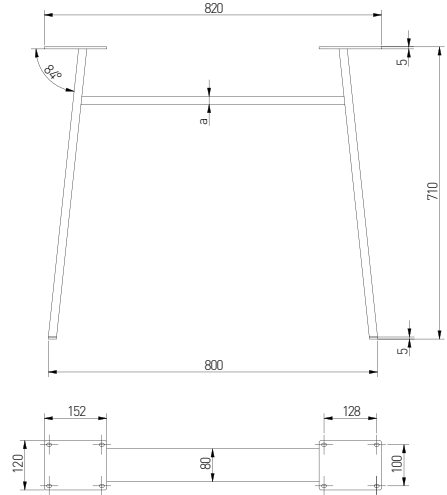

a
(mm)



NM-INDUSTRIA-H20-710X820-20M	noir mat	20	acier	1
NM-INDUSTRIA-H40-710X820-20M		40		

Pied de table en bois massif INDUSTRIA

Disponible maintenant

Une grande variété de designs offre la possibilité de nombreux arrangements

Il assure une solidité et une stabilité à votre plateau

Assemblage facile - pieds de table style industriel s'intègrent parfaitement dans la tendance DIY

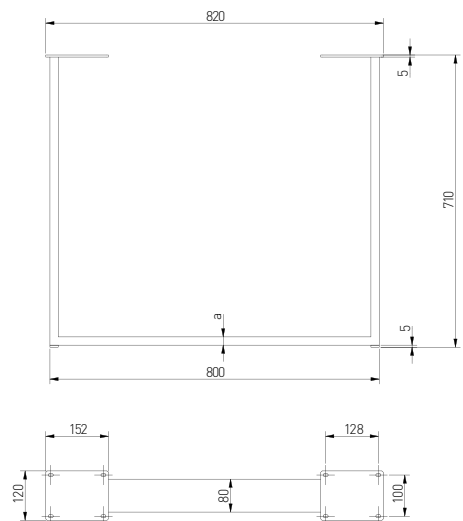

a
(mm)



NM-INDUSTRIA-P20-710X820-20M	noir mat	20	acier	1
NM-INDUSTRIA-P40-710X820-20M		40		
NM-INDUSTRIA-P80-710X820-20M		80		



Pied de table en bois massif INDUSTRIA

Disponible maintenant

Une grande variété de designs offre la possibilité de nombreux arrangements

Il assure une solidité et une stabilité à votre plateau

Assemblage facile - pieds de table style industriel s'intègrent parfaitement dans la tendance DIY

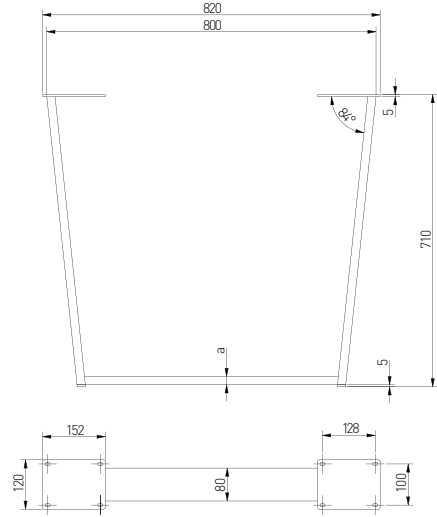

			a (mm)		
NM-INDUSTRIA-T20-710X820-20M	noir mat	acier	20	1	
NM-INDUSTRIA-T40-710X820-20M			40		

Pied de table en bois massif INDUSTRIA

Disponible maintenant

Une grande variété de designs offre la possibilité de nombreux arrangements

Il assure une solidité et une stabilité à votre plateau

Assemblage facile - pieds de table style industriel s'intègrent parfaitement dans la tendance DIY

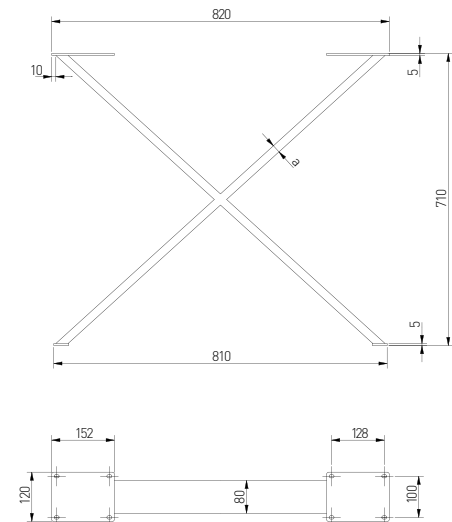

			a (mm)		
NM-INDUSTRIA-X20-710X820-20M	noir mat	acier	20	1	
NM-INDUSTRIA-X40-710X820-20M			40		
NM-INDUSTRIA-X80-710X820-20M			80		



S'inscrit parfaitement dans la tendance des intérieurs minimalistes

Les barres horizontales éliminent la nécessité de monter des poignées

Possibilité d'utiliser un éclairage LED

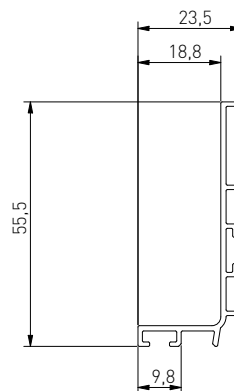

C mm	L mm						
		aluminium	acier brossé	blanc	noir mat	12.	aluminium
pour la découpe	3000	PA-VELLO-L3M-05	PA-VELLO-L3M-06	PA-VELLO-L3M-10	PA-VELLO-L3M-20M		

Accessoires



PA-ZASVELLO-LNL-20M



PA-ZASVELLO-LNP-20M



PA-ZASVELLO-LPL-20M



PA-ZASVELLO-LPP-20M



PA-MOUNT-GL-00

Capots de rail



PA-OSMLGLAXMIC3M-00N

aluminium	acier brossé	blanc	noir mat	10.	plastique
PA-ZASVELLO-LNL-05	PA-ZASVELLO-LNL-06	PA-ZASVELLO-LNL-10	PA-ZASVELLO-LNL-20M		
PA-ZASVELLO-LNP-05	PA-ZASVELLO-LNP-06	PA-ZASVELLO-LNP-10	PA-ZASVELLO-LNP-20M		
PA-ZASVELLO-LPL-05	PA-ZASVELLO-LPL-06	PA-ZASVELLO-LPL-10	PA-ZASVELLO-LPL-20M		
PA-ZASVELLO-LPP-05	PA-ZASVELLO-LPP-06	PA-ZASVELLO-LPP-10	PA-ZASVELLO-LPP-20M		

Possibilité d'utiliser un éclairage LED. Le diffuseur recommandé PA-OSMLGLAXMIC3M-00N

aluminium	50	acier
PA-MOUNT-GL-00		



S'inscrit parfaitement dans la tendance des intérieurs minimalistes

Les barres horizontales éliminent la nécessité de monter des poignées

Possibilité d'utiliser un éclairage LED

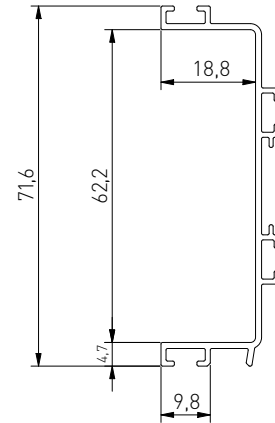

C mm	L mm						
		aluminium	acier brossé	blanc	noir mat	12	aluminium
pour la découpe	3000	PA-VELLO-C3M-05	PA-VELLO-C3M-06	PA-VELLO-C3M-10	PA-VELLO-C3M-20M		

Accessoires

Capots de rail



PA-ZASVELLO-CN-20M



PA-ZASVELO-CP-20M



PA-MOUNT-GL-00



PA-OSMLGLAXMIC3M-00N

aluminium	acier brossé	blanc	noir mat	10	plastique
PA-ZASVELLO-CN-05	PA-ZASVELLO-CN-06	PA-ZASVELLO-CN-10	PA-ZASVELLO-CN-20M		
PA-ZASVELLO-CP-05	PA-ZASVELLO-CP-06	PA-ZASVELO-CP-10	PA-ZASVELO-CP-20M		

Possibilité d'utiliser un éclairage LED. Le diffuseur recommandé PA-OSMLGLAXMIC3M-00N

aluminium	50	acier
PA-MOUNT-GL-00		



Système d'ouverture pour tiroir sans poignée VELLO

Disponible à partir d'avril

S'inscrit parfaitement dans la tendance des intérieurs minimalistes

Les barres verticales éliminent la nécessité de monter des poignées

Recommandé pour l'armoire de cuisine haute

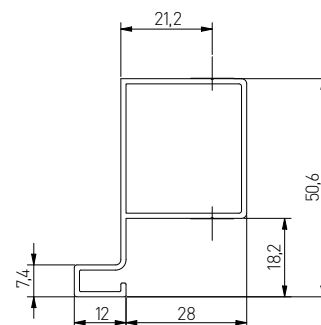

C mm	L mm						
		aluminium	acier brossé	blanc	noir mat	12	aluminium
pour la découpe	3000	PA-VELLO-TJ3M-05	PA-VELLO-TJ3M-06	PA-VELLO-TJ3M-10	PA-VELLO-TJ3M-20M		

Système d'ouverture pour tiroir sans poignée VELLO

Disponible à partir d'avril

S'inscrit parfaitement dans la tendance des intérieurs minimalistes

Les barres verticales éliminent la nécessité de monter des poignées

Recommandé pour l'armoire de cuisine haute

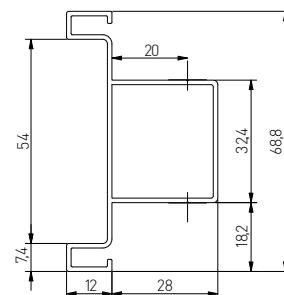

C mm	L mm						
		aluminium	acier brossé	blanc	noir mat	12	aluminium
pour la découpe	3000	PA-VELLO-TD3M-05	PA-VELLO-TD3M-06	PA-VELLO-TD3M-10	PA-VELLO-TD3M-20M		

Poignée UZ-133

Disponible à partir de juin

Design classique adapté à de nombreux espaces

Noir mat classique ajoute de l'élégance à votre intérieur

Nouvelle couleur

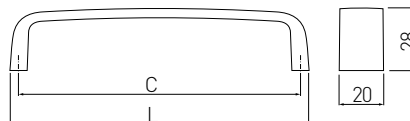

C mm	L mm			
		noir mat	25	ZnAl
128	135	UZ-133128-20M		

Poignée UZ-G1

Disponible à partir de juin

Design classique adapté à de nombreux espaces

Noir mat classique ajoute de l'élégance à votre intérieur

Nouvelle couleur

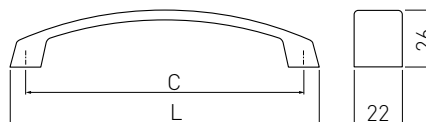

C mm	L mm			
		noir mat	20	ZnAl
128	142	UZ-G1-128-20M		
160	174	UZ-G1-160-20M		
192	206	UZ-G1-192-20M		
256	270	UZ-G1-256-20M		
320	334	UZ-G1-320-20M		

Poignée UZ-G2

Disponible à partir de juin

Poignée fine et droite aux lignes subtiles

Noir mat classique ajoute de l'élégance à votre intérieure

Nouvelle couleur

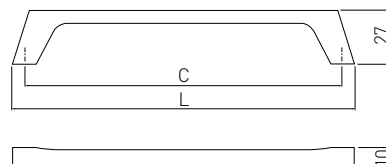

C mm	L mm			
		noir mat	25	ZnAl
160	172	UZ-G2-160-20M		
224	236	UZ-G2-224-20M		

Poignée UZ-Z10

Disponible à partir de juin

Poignée fine et délicate à la forme subtile

Noir mat classique ajoute de l'élégance à votre intérieur

Nouvelle couleur

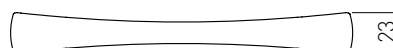
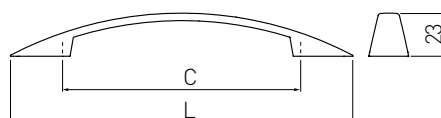

C mm	L mm			
		noir mat	50	ZnAl
96	138	UZ-Z10096-20M		
128	184	UZ-Z10128-20M		

Poignée CAPRI

Disponible à partir de juin

Design classique adapté à de nombreux espaces

Noir mat classique ajoute de l'élégance à votre intérieur

Nouvelle couleur

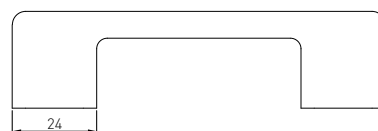
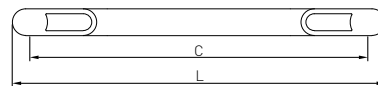

C mm	L mm			
C	L	noir mat		
128	138	UZ-CAPRI-128-20M	25	ZnAl
160	170	UZ-CAPRI-160-20M		
192	202	UZ-CAPRI-192-20M		
256	266	UZ-CAPRI-256-20M		

Poignée GENUA

Disponible à partir de juin

Idéal pour les meubles de bureau et de salon

Noir mat classique ajoute de l'élégance à votre intérieur

Nouvelle couleur

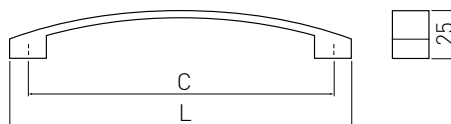

C mm	L mm			
		noir mat		
128	148	UZ-GENUA128-20M	40	ZnAl
160	180	UZ-GENUA160-20M	35	

Poignée UZ-40

Disponible à partir de juin

Poignée bouton géométrique et simple adapté à chaque tiroir

Noir mat classique ajoute de l'élégance à votre intérieur

Nouvelle couleur

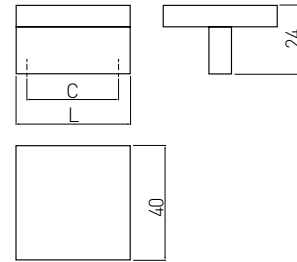

C mm	L mm			
		noir mat		
32	40	UZ-40-032-20M	50	ZnAl

Poignée LIND

Disponible à partir de juin

Poignée de bord s'intègre subtilement à la façade de meubles

Noir mat classique ajoute de l'élégance à votre intérieure

Nouveau design

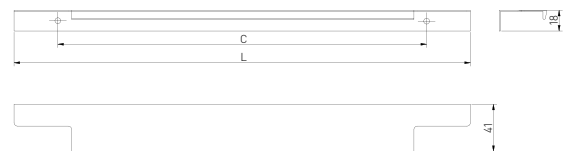

C mm	L mm					
		chrome	aluminium	or brossé	noir mat	
256	296	UA-LIND-256-296-01	UA-LIND-256-296-05	UA-LIND-256-296-18	UA-LIND-256-296-20M	25 aluminium
320	396	UA-LIND-320-396-01	UA-LIND-320-396-05	UA-LIND-320-396-18	UA-LIND-320-396-20M	
224	496*	UA-LIND-224-496-01	UA-LIND-224-496-05	UA-LIND-224-496-18	UA-LIND-224-496-20M	
256	596	UA-LIND-256-596-01	UA-LIND-256-596-05	UA-LIND-256-596-18	UA-LIND-256-596-20M	
352	796	UA-LIND-352-796-01	UA-LIND-352-796-05	UA-LIND-352-796-18	UA-LIND-352-796-20M	

* Fixation à 3 vis

Poignée VITO

Disponible à partir de juin

Poignée fine au design artistique

Noir mat classique ajoute de l'élégance à votre intérieur

Nouvelle couleur

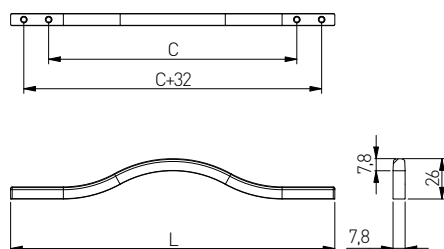

C mm	L mm			
		laiton doré	25	ZnAl
160	210	UZ-VITO-160-16		
288	340	UZ-VITO-288-16		

Poignée VENICE

Disponible à partir de juin

Design moderne adapté aux intérieurs minimalistes

Noir mat classique ajoute de l'élégance à votre intérieur

Nouveau design

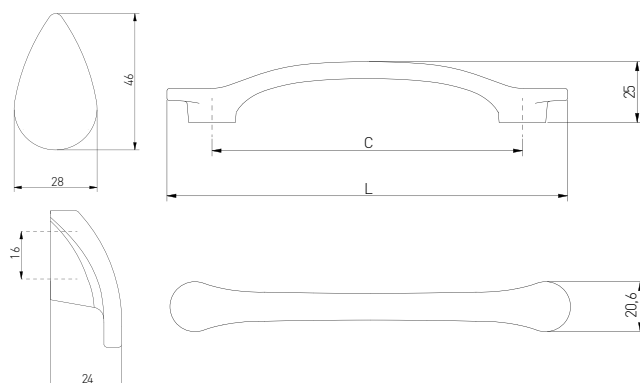

C mm	L mm				
		champagne	noir mat	20	ZnAl
128	165	UZ-VENICE-128-90	UZ-VENICE-128-20M		
gatka		GZ-VENICE-1-90	GZ-VENICE-1-20M		

Poignée OTTO

Disponible à partir de juin

Une poignée moderne et simple qui s'adapte parfaitement à chaque façade

Noir mat classique ajoute de l'élégance à votre intérieur

Nouveau design

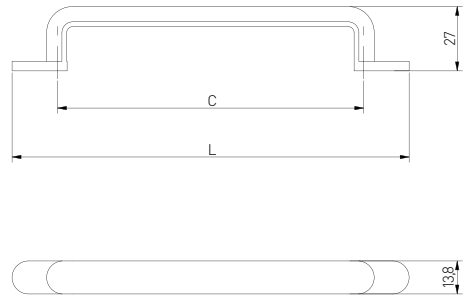

C mm	L mm					
		acier brossé	champagne	noir mat	20	ZnAl
128	166	UZ-OTTO-128-06	UZ-OTTO-128-90	UZ-OTTO-128-20M		
160	198	UZ-OTTO-160-06	UZ-OTTO-160-90	UZ-OTTO-160-20M		

Poignée EVER

Disponible à partir de juin

Design original, idéal pour les intérieurs classiques et rétro

Noir mat classique ajoute de l'élégance à votre intérieur

Nouveau design

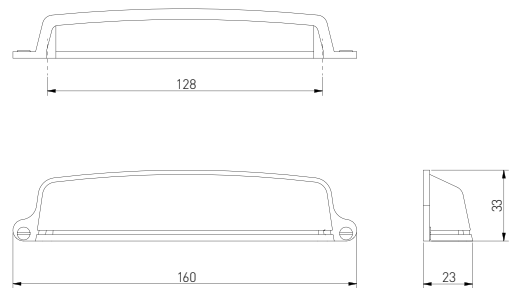

C mm	L mm					
		champagne	noir mat	20	ZnAl	
128	160	UZ-EVER-128-90	UZ-EVER-128-20M			

Poignée FLOW

Disponible à partir de juin

Design minimaliste et moderne

Noir mat classique ajoute de l'élégance à votre intérieur

Nouveau design

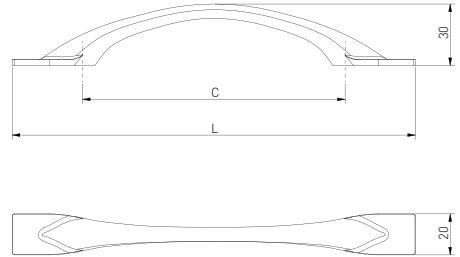

C mm	L mm	acier brossé	champagne	noir mat		
128	200	UZ-FLOW-128-06	UZ-FLOW-128-90	UZ-FLOW-128-20M	25	ZnAl
192	270	UZ-FLOW-192-06	UZ-FLOW-192-90	UZ-FLOW-192-20M	30	

Poignée STEP

Disponible à partir de juin

Design minimaliste et moderne

Noir mat classique ajoute de l'élégance à votre intérieur

Nouveau design

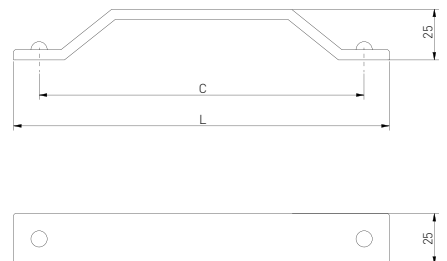

C mm	L mm	argent ancien	noir mat		
160	185	UZ-STEP-160-07	UZ-STEP-160-20M	25	ZnAl

Poignée RETRIS

Disponible à partir de juin

Poignée classique pour les intérieurs rétro et loft

Noir mat classique ajoute de l'élégance à votre intérieur

Nouveau design

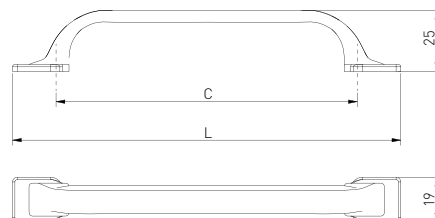

C mm	L mm					
		laiton ancien	argent ancien	noir mat	25	ZnAl
128	165	UZ-RETRIS-128-04	UZ-RETRIS-128-07	UZ-RETRIS-128-20M		

Poignée HEXI

Disponible à partir de juin

Poignée de bord s'intègre subtilement à la façade de meubles

Également disponible en noir dans une longueur de 3500 mm

Nouvelle couleur

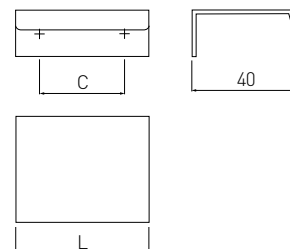
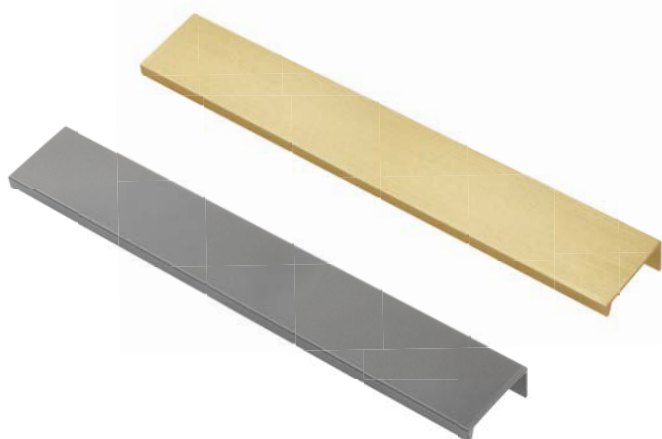

C mm	L mm				
		anthracite	or brossé	noir mat	
32	50	UA-HEXI-60	UA-HEXI-18	-	aluminium
96	150	UA-HEXI96-60	UA-HEXI96-18	-	
192	225	UA-HEXI192-60	UA-HEXI192-18	-	
pour la découpe	3500	-	-	UA-HEXI-3500-20M	

➤ Poignée de bord s'intègre subtilement à la façade de meubles

➤ Noir mat classique ajoute de l'élégance à votre intérieur

➤ Nouvelle couleur

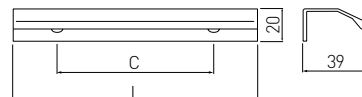
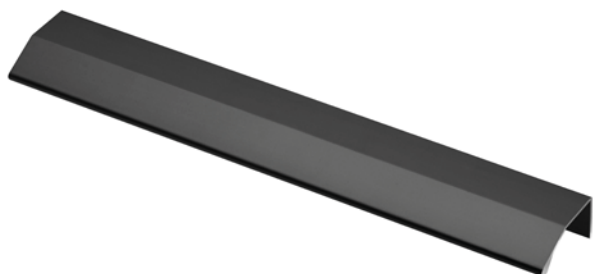

pour la découpe	3500	noir mat UA-TREX-3500-20M	24	aluminium



Ruban LED FLASH

Disponible à partir de juin

Couleur de la lumière: neutre



LD-5050-300-20-NE4	12 VDC, 14,4 W/m	900 lm/m	● 4000 K	65	120°	10	60/m	5
LD-5050-300-65-NE4		850 lm/m	● 4000 K					
LD-5630-300-20-NE4	12 VDC, 16 W/m	1750 lm/m	● 4000 K	20		8	120/m	2,5
LD-3528-600-20-NE4	12 VDC, 9,6 W/m	550 lm/m	● 4000 K					
LD-3528-600-65-NE4		520 lm/m	● 4000 K					
LD-3528-300-65-NE4	12 VDC, 4,8 W/m	280 lm/m	● 4000 K	65		10	60/m	5
LD-2835-600-65-NE4	12 VDC, 12 W/m	1350 lm/m	● 4000 K	20		10	120/m	2,5
LD-RGBW-300-20	12 VDC, 17 W/m	-	● RGBW			10	60/m	5



Ruban LED FLASH

Disponible à partir de juin

Couleur de la lumière: neutre



LD-3528-600-20-ZB-50	12DC, 9,6W/m	550 lm/m	● 6500 K	20	120°	8 mm	120/m	2,5
LD-3528-600-20-CB-50			● 4000 K					
LD-3528-600-20-NE4-50			● 3200 K					
LD-5050-300-20-NE4-50	12DC, 14,4W/m	900 lm/m	● 4000 K	20	120°	10 mm	60/m	5
LD-5630-300-20-NE4-50	12DC, 16W/m	1750 lm/m	● 4000 K					



- Ruban très flexible pour créer des formes complexes
- Ruban protégé de silicone naturel étanche- IP65
- Clips et embouts inclus



Code	W	lm/m	Température de couleur	IP	Angle	mm	x	cm
LD-NF12V6x12-65-ZB	12 VDC, 8 W/m	200 lm/m	● 6500 K	IP65	120°	6 mm	100/m	2,5
LD-NF12V6x12-65-NE			● 4000 K					
LD-NF12V6x12-65-CB			● 3200 K					

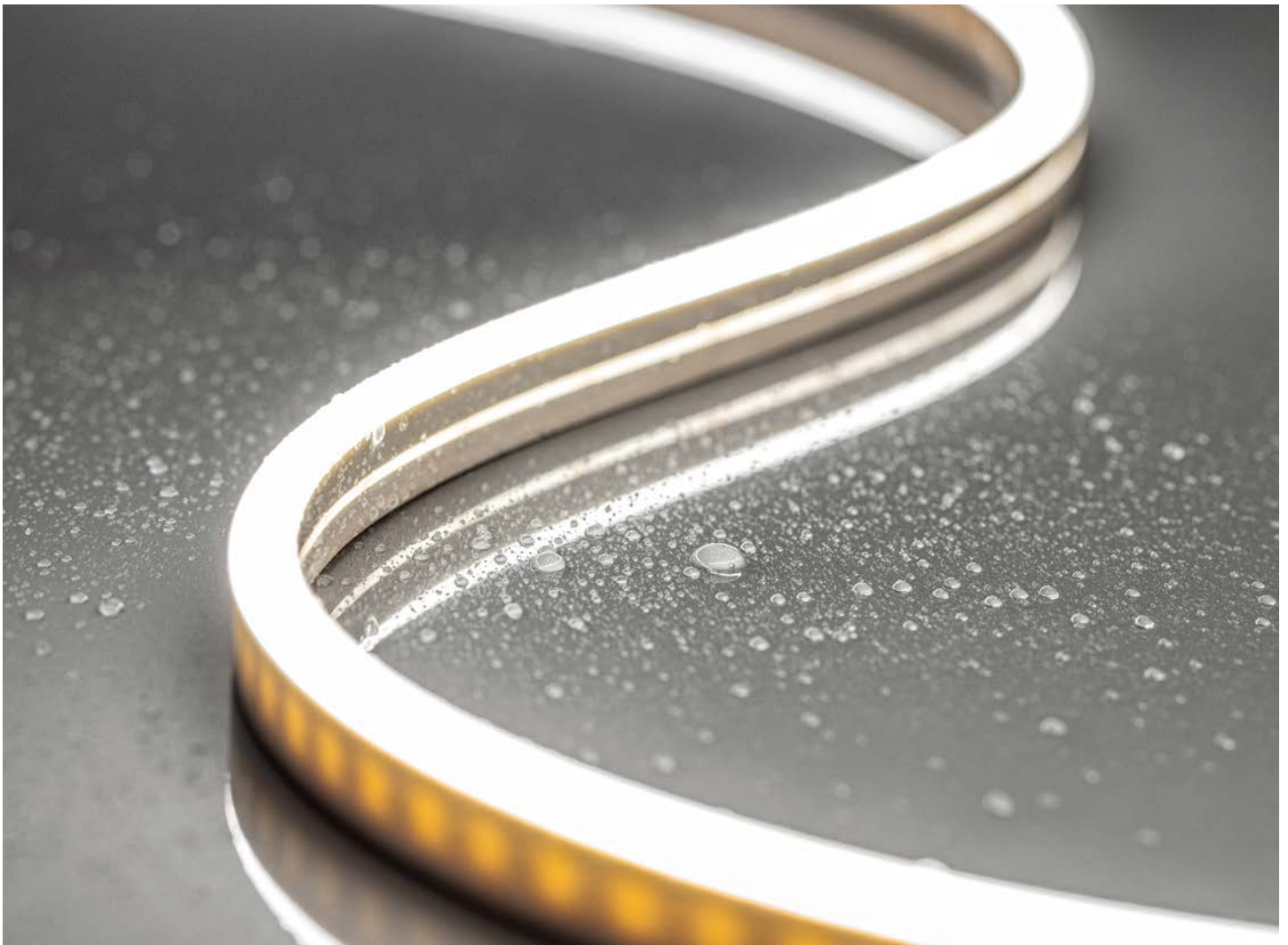

Kit RGBW, ruban LED 5 m, contrôleur, alimentation, télécommande

Disponible à partir d'avril

- Band LED RGBW 4 in 1 + blanc
- Densité du ruban 60 LEDs / 1m
- Kit prêt-à-connecter : ruban, alimentation, contrôleur

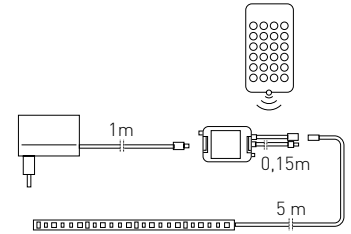

LD-ZLRGBW-300-20	12V	RGBW	plastique	10 mm	5 cm



Ruban LED COB

Disponible à partir d'avril

- Dernière technologie basée sur une diode COB
- Effet de ligne de lumière uniforme
- Efficacité lumineuse élevée et faible consommation d'énergie



LD-COB12V-20-ZB	12 VDC, 8 W/m	830 lm/m	6500 K	20	180°	8 mm	320/m	5
LD-COB12V-20-NE		800 lm/m	4000 K					
LD-COB12V-20-CB		750 lm/m	3200 K					





- Alimentation avec prises mini AMP intégrées, connexion rapide de la bande LED
- Dimensions plus petites
- Câble d'alimentation intégré

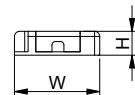

	max	i	A	LxWxH mm		
LD-ZAS09WEC-30	9 W	3 miniAMP	0,75 A	103 x 41 x 12mm	plastique	110 g
LD-ZAS15WEC-30	15 W	4 miniAMP	1,25 A	129 x 42 x 16 mm		130 g
LD-ZAS20WEC-30	20 W		1,67 A	129 x 42 x 16 mm		140 g
LD-ZAS30WEC-30	30 W	6 miniAMP	2,5 A	160 x 50 x 18 mm		190 g
LD-ZAS60WEC-30	60 W		5 A	190 x 62 x 21 mm		290 g



Profilé de jante GLAX

- Nouveaux profils de 3 mètres dans l'offre
- Nouvelles couleurs : inox, blanc et noir

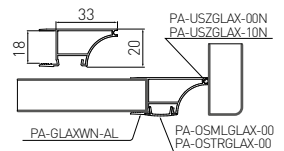

	BOARD mm	L m		
PA-GLAXWN3M-AL	18	3	argent	aluminium
PA-GLAXWN3M-AL-20M			noir	
PA-GLAXWN3M-AL-10			blanc	
PA-GLAXWN3M-AL-06			inox	



ul. Przejazdowa 21
05-800 Pruszków
Poland

 +48 22 44 47 272

 +48 22 44 47 366
+48 22 44 47 331

 +48 22 44 47 391

 + 48 22 44 47 379

 + 420 591 160 091

 +48 22 444 73 24

 +48 22 444 73 07

 +375 291 504 626

 +48 22 44 47 523

 +48 22 44 47 524

 +48 735 201 464

 +48 22 4447 525

 +48 22 44 47 297
+48 539 770 636

 ООО «ГТВ РУС»
140073 Московская область
город Люберцы, рабочий поселок Томилино
мкрн. Птицефабрика, Литер 7А

 GTV Croatia d.o.o
Kovinska 4a, 10000 Zagreb
Hrvatska
+ 385 1 798 8089

 GTV Czech Distribution s.r.o.
CTPark Ostrava, Na Rovince 879
720 00 Ostrava-Hrabová
Česká republika
+420 591 160 092
+420 727 800 362
+420 725 715 142

 GTV España Herrajes e Iluminación,
S.L., Avenida Aragón 30, Planta 8
46021 Valencia (España)
+ 34 961 134 441
+ 34 960 468 666
+ 48 22 444 73 77

fax: +48 22 444 75 01

e-mail: info@gtv.com.pl

www.gtv.com.pl

