



**GTV**

# **KATALOG PRODUKTŮ**

PRODUKTOVÝ **KATALÓG**

TERMÉK**KATALÓGUS**

**CATALOG** DE PRODUSE

OSVĚTLENÍ NÁBYTKU  
OSVETLENIE NÁBYTKU  
BÜTORVILÁGÍTÁS  
LUMINAT MOBILIER

SYSTÉMY POSUVNÝCH DVEŘÍ  
SYSTEMY POSUVNÝCH DVEŘÍ  
TOLÓAJTÓ RENDSZEREK  
SYSTEME DE UI CULISANTE

DEKORATIVNÍ PŘÍSLUŠENSTVÍ  
DEKORATIVNE DOPLNKY  
DEKORATÍV KIEGÉSZÍTŐK  
ACCESORII DECORATIVE

FUNKČNÍ PŘÍSLUŠENSTVÍ  
FUNKČNÉ DOPLNKY  
FUNKCIONÁLIS TARTOZÉKOK  
ACCESORII FUNZIONALE

CS

Společnost **GTV** je mezinárodní výrobce nábytkových doplňků a LED osvětlení. Máme více než 20 let zkušeností ve spolupráci s největšími výrobci nábytku na světě a miliony zákazníků, kteří používají naše produkty. Dnes jsme jedním z mezinárodních lídrů v distribuci nábytkových doplňků a LED osvětlení a působíme na desítkách trhů po celém světě. Sídlo společnosti GTV je moderní logistické centrum nacházející se 25 km od centra polského hlavního města Varšavy. Od května 2023 pracujeme v novém distribučním centru, které má 30 000 m<sup>2</sup> skladovací plochy třídy A a 1 500 m<sup>2</sup> kancelářských prostor. Centrum nám umožňuje další rozšíření na 64 000 m<sup>2</sup>. Díky své moderní infrastruktuře jsme schopni plnit objednávky z celého světa v termínech požadovaných zákazníkem. Implementujeme svoji dlouhodobou obchodní strategii a aktivně propaguje své produkty účastí na nejprestižnějších světových veletrzích, např. v Německu, Itálii, Polsku, Brazílii. Profesionální servis, kompetentní tým specialistů a transparentní postupy nám umožňují efektivně plnit potřeby obchodních partnerů.

SK

Spoločnosť **GTV** je medzinárodný výrobca nábytkových doplnkov a LED osvetlenia. Máme viac ako 20 rokov skúseností v spolupráci s najväčšími výrobcami nábytku na svete a milióny zákazníkov, ktorí používajú naše produkty. Dnes sme jedným z medzinárodných lídrov v distribúcii nábytkových doplnkov a LED osvetlenia a pôsobíme na desiatkach trhov po celom svete. Sídlo spoločnosti GTV je moderné logistické centrum nachádzajúce sa 25 km od centra hlavného mesta Poľska, Varšavy. Od mája 2023 pracujeme v novom distribučnom centre, ktoré má 30 000 m<sup>2</sup> skladovacej plochy triedy A a 1 500 m<sup>2</sup> kancelárskych priestorov. Centrum nám umožňuje ďalšie rozšírenie na 64 000 m<sup>2</sup>. Vďaka svojej modernej infraštruktúre sme schopní plniť objednávky z celého sveta v termínoch požadovaných zákazníkom. Implementujeme svoju dlhodobú obchodnú stratégiu a aktívne propaguje svoje produkty účasťou na najprestížnejších svetových veľtrhoch, napr. v Nemecku, Taliansku, Poľsku, Brazílii. Profesionálny servis, kompetentný tím špecialistov a transparentné postupy nám umožňujú efektívne plniť potreby obchodných partnerov.

HU

A **GTV** a bútor kiegészítők és a LED világítás nemzetközi gyártója. A GTV több mint 20 éves tapasztalattal rendelkezik a világ legnagyobb bútorgyártóival való együttműködésben és több millió ügyfél használja a cég termékeit. Ma a bútor kiegészítők és a LED világítás terjesztésének egyik nemzetközi vezetője, világszerte több tucat piacon van jelen. GTV központja egy modern logisztikai központ, amely 25 km-re található Varsótól, a lengyel főváros központjától. 2023 májusa óta egy új elosztó központban dolgozunk, amely 30 000 m<sup>2</sup> A osztályú raktárterülettel és 1 500 m<sup>2</sup> irodaterülettel rendelkezik. A központ további bővítési lehetőséget ad 64.000 m<sup>2</sup>-ig. Modern infrastruktúrájával a vállalat képes teljesíteni a világ minden tájáról érkező megrendeléseket az ügyfél által megjelölt időpontban. A GTV végrehajtja hosszú távú üzleti stratégiáját, aktívan népszerűsíti termékeit azzal, hogy részt vesz a világ legrangosabb szakkiallításain pl. Oroszországban, Németországban, Olaszországban, Lengyelországban, Brazíliában. Professzionális szolgáltatás, hozzáértő szakembercsoport és kifejezett eljárások lehetővé teszik számunkra, hogy hatékonyan kielégítsük az üzleti partnerek igényeit.

RO

**GTV** este un producător internațional de accesorii pentru mobilier și iluminat cu LED-uri. GTV are peste 20 de ani de experiență în cooperare cu cei mai mari producători de mobilă din lume și milioane de clienți care utilizează produsele companiei. Astăzi GTV este unul dintre liderii internaționali în distribuția de accesorii pentru mobilier și iluminat cu LED, prezent pe zeci de piețe din întreaga lume. Sediul central al GTV este un centru logistic modern, situat la 25 km de centrul capitalei poloneze, Varșovia. Din mai 2023, lucrăm într-un nou centru de distribuție care are 30.000 m<sup>2</sup> de spațiu de depozitare clasa A și 1.500 m<sup>2</sup> de spațiu de birouri. Centrul ne oferă posibilitatea extinderii în continuare la 64.000 m<sup>2</sup>. Cu infrastructura sa modernă, compania este capabilă să îndeplinească comenzile din întreaga lume la momentul indicat de client. GTV își pune în aplicare strategia de afaceri pe termen lung, promovează în mod activ produsele sale, participând la cele mai prestigioase târguri din lume, de exemplu în Rusia, Germania, Italia, Polonia, Brazilia. serviciul profesional, echipa competentă de specialiști și procedurile transparente ne permit să satisfacem în mod eficient nevoile partenerilor de afaceri.





**GTV**  
FURNITURE  
ACCESSORIES

- CS** Značka GTV Furniture Accessories je na trhu již více než 20 let a buduje si pozici jednoho z mezinárodních lídrů. Společnost působí v Evropě, Asii a Americe, zatímco produkty s logem GTV lze najít v milionech domácností a kancelářích po celém světě. Díky pečlivě naplánované strategii a logistice může GTV nabízet produkty s poměrem ceny a kvality nedosažitelným pro jiné společnosti.
- SK** Značka GTV Furniture Accessories je na trhu už viac ako 20 rokov a buduje si pozíciu jedného z medzinárodných lídrov. Spoločnosť pôsobí v Európe, Ázii a Amerike, zatiaľ čo produkty s logom GTV môžete nájsť v miliónoch domácností a kancelárií po celom svete. Vďaka starostlivo naplánovanej stratégii a logistike môže GTV ponúkať produkty s pomerom ceny a kvality nedosiahnuteľným pre iné spoločnosti.
- HU** A GTV Furniture Accessories márka több mint 20 éve van jelen a piacon, megerősítve ezzel pozícióját a nemzetközi vezetők között. A vállalat Európában, Ázsiában és Amerikában van jelen, míg a GTV logóval ellátott termékek világszerte több millió háztartásban és irodában található. A gondosan megtervezett stratégiának és logisztikának köszönhetően, GTV más vállalatok számára elérhetetlen ár-minőség arányú termékeket kínál.
- RO** Marca de accesorii pentru mobilă GTV este prezentă pe piață de peste 20 de ani, consolidându-și poziția ca unul dintre liderii internaționali. Compania este prezentă în Europa, Asia și America, în timp ce produsele cu sigla GTV se găsesc în milioane de gospodării și birouri din întreaga lume. Datorită strategiei și logisticii planificate cu atenție, GTV poate oferi produse cu un raport de preț / calitate inaccesibil pentru alte companii.

- CS** Značka GTV Sliding Door Systems byla vyvinuta v roce 2014 pro profesionály, kteří hledají spolehlivost a nejvyšší kvalitu. Naše systémy byly vytvořeny tak, aby vyhovovaly potřebám i těch nejnáročnějších zákazníků. Myšlenka systémů byla inspirována názory stolařů, kteří mají tendenci hledat řešení, která zefektivní jejich práci. GTV Sliding Door Systems nabízí nejen praktická konstrukční vylepšení. Ale také nejvyšší kvalitu komponentů. Celý systém je založen na spolehlivých prvcích, zejména válečcích, díky nimž tento systém převyšuje konkurenci. Všechny funkční doplňky byly pečlivě vybrány a prošly důkladnou a přísnou kontrolou kvality.
- SK** Značka GTV Sliding Door Systems bola vyvinutá v roku 2014 pre profesionálov, ktorí hľadajú spoľahlivosť a najvyššiu kvalitu. Naše systémy boli vytvorené tak, aby vyhovovali potrebám aj tých najnáročnejších zákazníkov. Myšlienka systémov bola inšpirovaná názormi stolařov, ktorí majú tendenciu hľadať riešenia, ktoré zefektívnia ich prácu. Systémy posuvných dverí od GTV ponúkajú nielen praktickú konštrukčnú vylepšenia. Ale tiež najvyššiu kvalitu komponentov. Celý systém je založený na spoľahlivých prvkoch, najmä valčekov, vďaka ktorým tento systém prevyšuje konkurenciu. Všetky funkčné doplnky boli starostlivo vybrané a prešli dôkladnou a prísnou kontrolou kvality.
- HU** A GTV Sliding Door Systems egy 2014-ben kifejlesztett márka a megbízhatóságot és a legmagasabb minőséget kereső szakemberek számára. Rendszerünket a legigényesebb ügyfelek igényeinek kielégítésére hoztuk létre. A rendszerek ötletét az ácsok ihlették, akik hajlamosak olyan megoldásokat keresni, amelyek hatékonyabbá teszik munkájukat. A GTV tolóajtó rendszerek nemcsak gyakorlati konstrukciós fejlesztéseket kínálnak, de a legjobb minőségű alkatrészeket is. Az egész rendszer megbízható elemekre épül, különösen a görgők, amelyeknek köszönhetően ez a rendszer kiemelkedik a versenytársak közül. Az összes funkcionális kiegészítőt gondosan megválasztották, és alaposan szigorú minőségellenőrzésnek vetették alá.
- RO** GTV Sliding Door Systems este un brand dezvoltat în 2014, pentru profesioniști care caută fiabilitate și cea mai înaltă calitate. Sistemele noastre au fost create pentru a satisface nevoile celor mai pretențioși clienți. Ideea din spatele sistemelor a fost inspirată de tâmplari, care tind să caute soluții, care să le facă munca mai eficientă. Sistemele de uși glisante GTV oferă nu numai îmbunătățiri practice în construcție. Dar și cea mai înaltă calitate a componentelor. Întregul sistem se bazează pe elemente fiabile, în special role, datorită cărora acest sistem iese în afara concurenței. Toate accesoriile funcționale au fost atent selectate și au fost supuse unui control strict al calității.

- CS** Značka GTV Lighting byla uvedena na trh v roce 2007 a byla vytvořena s cílem poskytovat profesionální řešení osvětlení založená na technologii LED pro kanceláře, průmyslové budovy a sklady. Portfolio zahrnuje také LED řešení pro soukromé spotřebitele – osvětlení domu a zahrady, osvětlení nábytku. GTV Lighting nabízí také široké a kompletní portfolio služeb, jako je poradenství při plánování osvětlení.
- SK** Značka GTV Lighting bola uvedená na trh v roku 2007 a bola vytvorená s cieľom poskytovať profesionálne riešenia osvetlenia založené na technológii LED pre kancelárie, priemyselné budovy a sklady. Portfólio zahŕňa aj LED riešenia pre súkromných spotrebiteľov – osvetlenie domu a záhrady, osvetlenie nábytku. Značka GTV Lighting ponúka aj široké a kompletne portfólio služieb, ako je poradenstvo pri plánovaní osvetlenia.
- HU** A GTV Lighting márka 2007-ben indult, és azért jött létre, hogy professzionális világítási megoldásokat biztosítson irodákhoz, ipari épületekhez és raktárakhoz - LED technológián alapulva. A portfólió LED-megoldásokat is tartalmaz magánfogyasztók számára - otthoni és kerti világítás, bútorvilágítás. A GTV Lighting széles és teljes körű szolgáltatást is kínál, mint például a világítástervezési tanácsadás.
- RO** Marca GTV Lighting a fost lansată în 2007, a fost creată, pentru a oferi soluții profesionale de iluminat pentru birouri, clădiri industriale și depozite - bazate pe tehnologia LED. Portofoliul include și soluții LED pentru consumatori privați - iluminat pentru casă și grădină, iluminat pentru mobilier. GTV Lighting oferă, de asemenea, un portofoliu larg și complet de servicii, precum consultanță în planificarea iluminatului.

- CS** GTV Decor je značka dekorativního osvětlení vytvořená v souladu s nejpovětšími trendy světového designu. Náš cíl je oslovit zákazníky s různými potřebami a podpořit je v jejich individuálních domácích projektech. Naše dekorativní osvětlení zajišťuje kvalitní využití prostoru. Studujeme současné trendy v designu, ve kterých individuální styl interiéru odráží identitu klienta. Portfolio společnosti GTV DECOR zahrnuje širokou škálu designů a trendů, nenápadné barvy jsou vhodné pro každého spotřebitele. Bílé, šedé a černé odstíny, promyšlené detaily a množství barev, to vše je v naší nabídce - více než 70 designů svítidel.
- SK** GTV Decor je značka dekoratívneho osvetlenia vytvorená v súlade s najnovšími trendmi svetového dizajnu. Naším cieľom je osloviť zákazníkov s rôznymi potrebami a podporiť ich v ich individuálnych projektoch. Naše dekoratívne osvetlenie zabezpečuje kvalitné využitie priestoru. Studujeme aktuálne dizajnové trendy, v ktorých individuálny štýl interiéru odraža identitu klienta. Portfólio GTV DECOR zahŕňa širokú škálu dizajnov a trendov, nenápadné farby sú vhodné pre každého spotrebiteľa. V našej ponuke nájdete biele, sivé a čierne odtiene, premyslené detaily a množstvo farieb - viac ako 70 dizajnov svietidiel.
- HU** A GTV Decor egy olyan dekoratív világítási márka, amelyet a globális design irányzatok legújabb trendjei szerint hoztak létre. Célunk, hogy elérjük a különböző igényekkel rendelkező ügyfeleket, és támogassuk őket egyéni lakásprojektekben. Olyan dekoratív világítási megoldásokat nyújtunk, amelyek biztosítják a tér minőségű kihasználását. Követjük az aktuális tervezési trendeket, amelyekben a belső tér egyéni stílusa tükrözi az ügyfél identitását. A GTV DECOR portfóliójában található számos dizájn és a divatos, visszafogott színek mindenki számára megoldást nyújtanak. Fehér, szürke, fekete árnyalatok, jól átgondolt részletek és megannyi lámpa - mindez megtalálható a több mint 70 lámpatest-kialakítást tartalmazó termékkinálatunkban.
- RO** GTV Decor este o marcă de iluminat decorativ, care a fost creată în conformitate cu cele mai recente tendințe în designul mondial. Scopul nostru este de a ajunge la clienți cu preferințe diferite și de a-i sprijini în proiectele lor individuale de amenajare a locuințelor. Oferim un iluminat decorativ care asigură o utilizare de calitate a spațiului. Urmărim tendințele actuale în materie de design, în care stilul individual al interiorului reflectă identitatea clientului. Bogăția de modele și culorile la modă, în nuanțe discrete, înseamnă că în portofoliul GTV DECOR fiecare va găsi ceva pentru sine. Nuanțe de alb, gri, negru, detalii bine gândite și o varietate de lămpi - toate acestea pot fi găsite în produsele noastre profesionale, care includ peste 70 de modele de corpuri de iluminat.

## FUNKČNÍ PŘÍSLUŠENSTVÍ FUNKČNÉ DOPLNKY FUNKCIONÁLIS TARTOZÉKOK ACCESORII FUNCȚIONALE

Závěsy Závesy Pántok Balamale	66 – 107
Tlumiče Tlmiče Fék, Csillapító Amortizor	108 – 113 / 124 – 126
Vzpěry Výklopy Teleszkóp Pistoane	114 – 123
Výsuvy Výsuvy Fióksínek Sine	128 – 163
Zásuvkové systémy Zásuvkové systémy Fiókos rendszerek Sisteme de sertare	166 – 216
Podpěry a spojovací kování Podpery a spojovacie kovanie Tartók és szerelvények Suporturi și accesorii	221 – 250
Lišty na pracovní desky Lišta na pracovnú dosku Munkalap szalag Banda pentru blat	251 – 253
Šatní tyče a příslušenství Šatníkové tyče a príslušenstvo Sínek tartozékai és szerelvényei Accesorii pentru bara	254 – 269
Šatní příslušenství Šatníkové doplnky Szekrény kiegészítők Accesorii pentru garderobă	270 – 293
Kuchyňské příslušenství Kuchynské doplnky Konyhai kiegészítők Accesorii de bucatarie	218 – 221 / 294 – 319
Kancelářské příslušenství Kancelárske doplnky Irodai kiegészítők Accesorii de birou	320 – 332
Jiné Iné Egyéb Altele	333 – 337

## DEKORATIVNÍ PŘÍSLUŠENSTVÍ DEKORATÍVNE DOPLNKY DEKORATÍV KIEGÉSZÍTŐK ACCESORII DECORATIVE

Úchytky Úchytky Fogantyúk Mánere	340 – 447
Věšáky Vešíaky Fogasok Agatatoare	448 – 455

Policové podpěry Policové podpery Polcartók	
Suporturi pentru raft	456 – 463
Nábytkové nožky Nábytkové nožky Bútorlábak	
Picioare de mobilier	464 – 484
Nábytkové nohy Nábytkové nohy Bútor görgök	
Rotile pentru mobilă	485 – 499
Nábytková kolečka Nábytková kolieska Alsó rendszerek	
Sisteme de rulare inferioare	500 – 505

## SYSTEMY POSUVNÝCH DVEŘÍ SYSTEMY POSUVNÝCH DVEŘÍ TOLÓAJTÓ RENDSZEREK SISTEME DE UȘI CULISANTE

Spodní pojezdové systémy Spodné pojazdové systémy Alul futó rendszerek	
Sisteme de rulare de jos	511 – 540
Horní pojezdové systémy Horné pojazdové systémy Felső rendszerek	
Sisteme de rulare superioare	541 – 545

## OSVĚTLENÍ NÁBYTKU OSVETLENIE NÁBYTKU BÚTORVILÁGÍTÁS ILUMINAT MOBILIER

LED pásy LED pásiky LED szalagok	
Benzi LED	550 – 555
LED profily LED profily LED profilok	
Profiluri LED	556 – 587
LED svítidla LED svietidlá LED szerelvények	
Spoturi LED	588 – 595
Příslušenství Doplnky Kiegészítők	
Accesorii	596 – 625
Zásuvky na stoly Zásuvky na stoly Asztali csatlakozók	
Prize de birou	626 – 647

**FUNKČNÍ PŘÍSLUŠENSTVÍ  
FUNKČNÉ DOPLNKY  
FUNKCIONÁLIS TARTOZÉKOK  
ACCESORII FUNCȚIONALE**



69

ZM-OT-STANDARD



69

ZM-HCSL09-3D



70

ZM-HCSL08-3D



70

ZM-HCSL07-3D



71

PZ-HCSL-H0-BE0



71

PZ-HCSL3D-H0-BE0



71

PZ-HCSL-H0-M5



71

ZM-COVERHCSL-SET



71

ZM-DCHC09-3DBE0



72

ZM-DCHC08-3DBE0



72

ZM-DCHC07-3DBE0



73

ZM-EHC09BE0









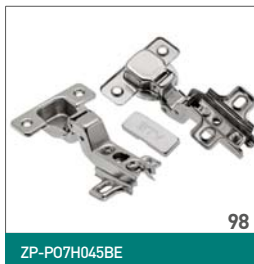



104

ZP-KT0270-BE



104

ZT-HF-01-D00



105

ZT-HF-01-M00



105

ZP-JUNIOR-00



106

ZP-SKR-00-80



106

ZC-GTV-12-00



107

PD-MD-ZB-01-KPL



107

ZM-SZABLON-ZAW



108

AM-KRZYZ-KPL



108

AM-ODB000-60



109

AM-ADAP0B-60



109

AM-ADAP0A-60



110

AM-OWM-KR-MG-10



112

AM-OWM-DL-MG-10



111

AM-PL-DL-MAG



111

AM-PL-DL-M



112

AM-OAM-KR-MG-10



112

AM-OAM-DL-MG-10



113

AM-ZAT-A1-10



113

AMR-BP-1003



114

PD-LIFTNEW-LIGHT-10



114

PD-LIFT-P20-LIGHT-10



115

PD-MINILIFTNEW-LIGHT



116

PD-GAM050-N02



118

PD-G0050-N02



119

PD-G0050-N03



120

PD-G60160-02



121

PD-GPD01-001



122

PD-PD000-001



123

PD-PD000-001B

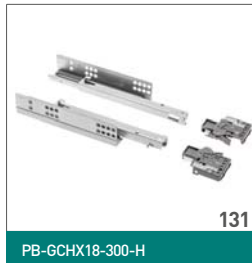









170

PB-AXISPRO-P20-KPL250C



171

PB-AXISPRO-P20-KPL250D



171

PB-AXISPRO-WEWMOCA



172

PB-AXISPRO-WEWMOCB



172

PB-AXISPRO-WEWMOCC



173

PB-AXISPRO-WEWMOCD



173

PB-AXISPRO-ZESWEW-A AXISPRO



174

PB-AXISPRO-ZESWEW-B AXISPRO



174

PB-AXISPRO-ZESWEW-C AXISPRO



175

PB-AXISPRO-ZESWEW-D AXISPRO



175

PB-AXISPRO-RELKW300



175

PB-AXISPRO-ZNACZ-FRONT



177

PB-MBPRO-KPL300A



177

PB-MBPRO-KPL300B



178

PB-MBPRO-KPL300C



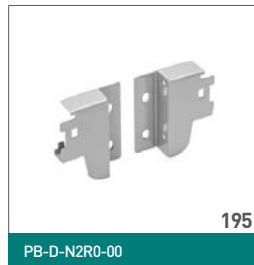
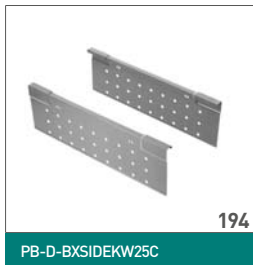

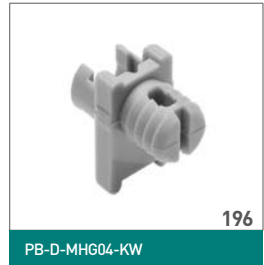
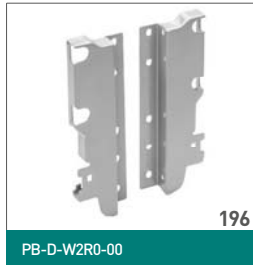

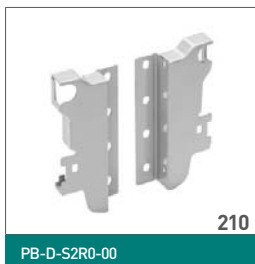
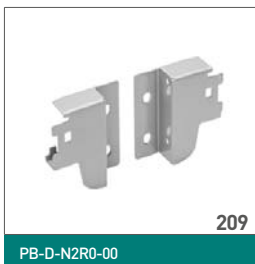
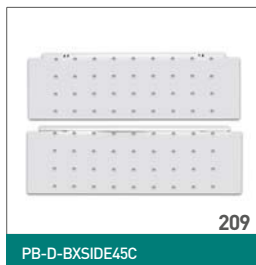
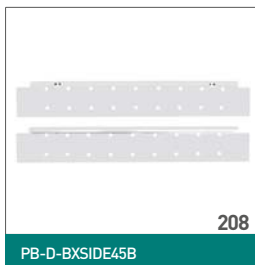

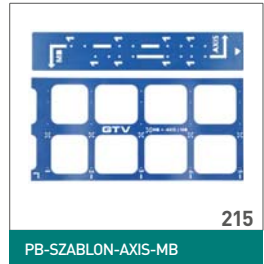
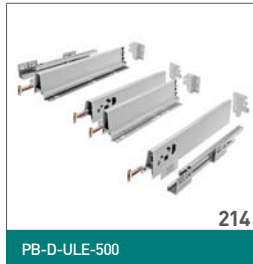







230

MC-K135-06-01



230

MC-J01A-12-01



231

MC-J04A2-14-01



231

MC-J60A27-01



232

MC-J62-01



232

PP-GL-DR5-01



233

PP-SPL001-01



233

MR-ZSL011-01



234

PP-SMART-000



234

PP-NW09X90B



235

PP-LUK-00-01



235

WB-073024-01



236

WB-073025-01



236

WB-073026-01



237

WB-WS-12-010





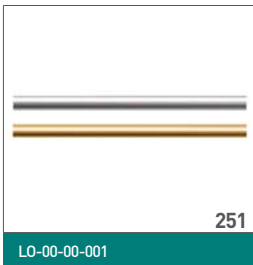
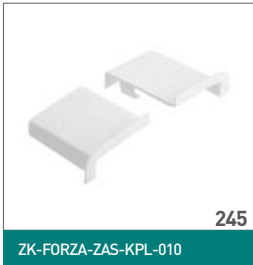











297

PB-45-MF002X20-60A



298

PB-45-002X15-60A



299

PB-45-MF2X15-60A



300

PB-45-450-2X20-60A



301

PB-45-450MF202X10-60A



302

PB-45-MF342X17-60A



303

PB-45-600MF-2X27-60A

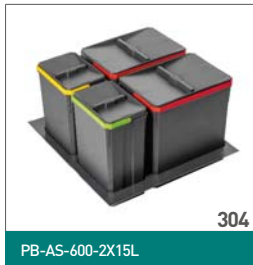

304

PB-AS-600-2X15L



305

PB-93004162601



305

PB-91024160V



306

KO-WMC450-60



307

KO-UMC450-60



308

KO-150BO-60



310

KO-300BO-60



311

KO-150BO-E-01



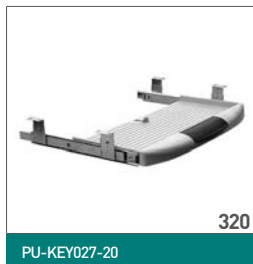
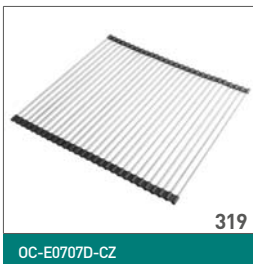





**DEKORATIVNÍ PŘÍSLUŠENSTVÍ  
DEKORATÍVNE DOPLNKY  
DEKORATÍV KIEGÉSZÍTŐK  
ACCESORII DECORATIVE**



340

UA-EXTEND-1200-20M



341

UA-HEXA-1200-20M



342

UZ-OCTAVIO-128-01

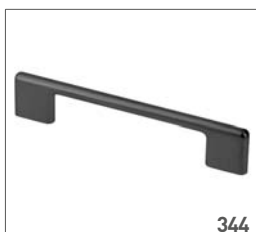

344

UZ-CAPRI-96-01



345

GZ-SPOT-1-06



346

UZ-BAGIO-128-01



347

UZ-VITO-160-01



348

GZ-DUNE-1-06



349

GZ-PIAZZA-1-18



350

UZ-FLAVIO-96-01



351

UZ-MONZA160-06



351

UZ-MONA-128-01-10















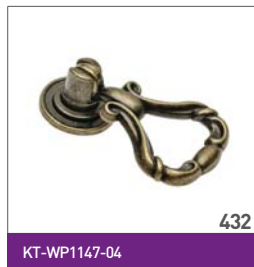





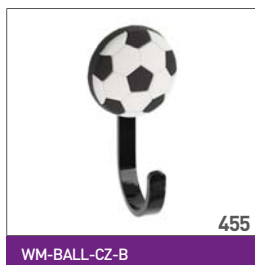

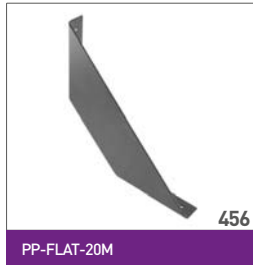







474

NM-RONDA-150-18



474

NM-MDN-D4-01



475

NM-MDN926-01



475

NM-MDN927-01



476

NM-MDN941-01



476

NM-WPJ22-D20



477

BP-SLZIGW-10



477

BP-SLZIGW-21



478

NM-STOPKA-M6



478

NM-STOPK SZESTK-M6



479

NM-MUFAWB-00



479

NM-DPD20-100



480

NM-KL-DPL-20



480

NM-DPA20-100



481

NM-KL-DPA-20



481

NM-MLA-50-75



482

NM-MLA-65-85



482

NM-MLA-85-125



483

NM-MLA-95-145



483

NM-MLA-125-195



484

NM-MLA-KL



485

NM-A60710-01



486

NM-A80710-01



487

NM-G60710-01N



488

NM-S60710-01A



489

NM-F50710-01



490

NM-X-LINE40710-01



492

NM-ARTO-10-3R304-20M



493

NM-ARTO-10-2R304-20M



494

NM-INDUSTRIA-H20-710X820-20M

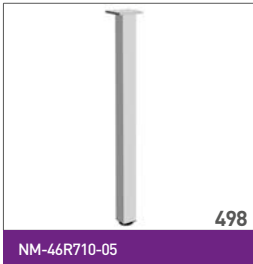



**SYSTEMY POSUVNÝCH DVEŘÍ  
SYSTEMY POSUVNÝCH DVEŘÍ  
TOLÓAJTÓ RENDSZEREK  
SISTEME DE UȘI CULISANTE**



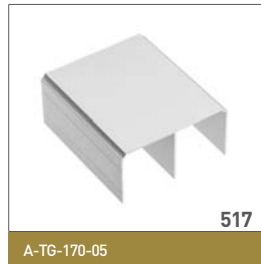
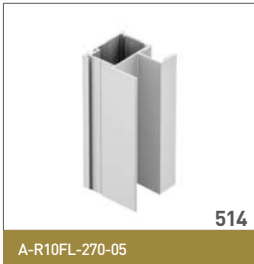











537

A-USZCZ-CHM4



537

A-USZCZ-TDEV02



537

A-B63-40



538

A-B63-32



538

A-SOFT-30



538

A-MSOFT-RAMA



538

A-SOFT-30Z



539

A-MSOFT-ADAPT



539

ZZ-SP-105-05



539

A-PW-RC-DOC



540

A-TMITO-200-00



540

A-MITO-PLUS



541

A-SN-FSET



542

A-SN-HSET1



543

A-SN-SDP-TU





544

A-BUDP-SET



545

A-SN-LOFT-200-20MN

**OSVĚTLENÍ NÁBYTKU  
OSVETLENIE NÁBYTKU  
BÚTORVILÁGÍTÁS  
ILUMINAT MOBILIER**



550

LD-3528-300-20-ZB



552

LD-3528-300-20-ZB-50



552

LD-2835-24V-300-20-ZB



553

LD-ZL5RGB150-00



554

LD-C0B12V-20-ZBN



554

LD-C0B24V-20-ZBN



555

LD-NF-12V6x12-65-ZB



556

PA-GLAXGKL3M-00C



558

PA-GLAXGKS3M-00C







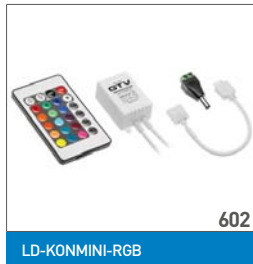
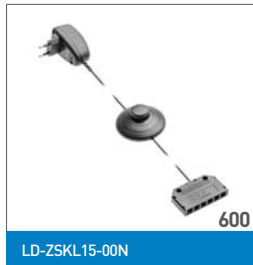





614

AE-WPDRW-00



615

AE-WLPR-60



615

AE-WLB01-10



616

AE-WLIP44-15



616

LD-DIMLED-10



617

AE-WLLAN1-10



617

AE-WLSZN1-10



618

LD-KABE2M-00



618

LZ-KA2MM-10



619

LZ-KAPR2M-10



619

LZ-AKZ312-10N



620

LZ-AKZ612-10N



620

LD-ZTL82MAMP-COB



621

LD-ZTL8MM-02N600



621

LD-ZTKT8MM-02N600







640

AE-BPW3GU-20



642

AE-BPW3U60-20



643

AE-PB03GS-53



643

AE-PBU02GS-10



644

AE-PBSC3GS-53



646

AE-PBC3GS-53BKS



646

AE-PBC3GS-51BK



647

AE-PBKT4S-80



**FUNKČNÍ PŘÍSLUŠENSTVÍ**  
**FUNKČNÉ DOPLNKY**  
**FUNKCIONÁLIS TARTOZÉKOK**  
**ACCESORII FUNCȚIONALE**

Závěsy Zăvesy Pántok Balamale	66 – 107
Tlumiče Tlmiče Fék, Csillapító Amortizor	108 – 113 / 124 – 126
Vzpěry Výklopy Teleszkóp Pistoane	114 – 123
Výsuvy Výsuvy Fióksínek Sine	128 – 163
Zásuvkové systémy Zásuvkové systémy Fiókos rendszerek Sisteme de sertare	166 – 216
Podpěry a spojovací kování Podpery a spojovacie kovanie Tartók és szerelvények Suporturi și accesorii	221 – 250
Lišty na pracovní desky Lišta na pracovnú dosku Munkalap szalag Banda pentru blat	251 – 253
Šatní tyče a příslušenství Šatníkové tyče a príslušenstvo Sínek tartozékai és szerelvényei Accesorii pentru bara	254 – 269
Šatní příslušenství Šatníkové doplnky Szekrény kiegészítők Accesorii pentru garderobă	270 – 293
Kuchyňské příslušenství Kuchyňské doplnky Konyhai kiegészítők Accesorii de bucatarie	218 – 221 / 294 – 319
Kancelářské příslušenství Kancelárske doplnky Irodai kiegészítők Accesorii de birou	320 – 332
Jiné Iné Egyéb Altele	333 – 337





**MB**

MODERN BOX

## Přibližné množství závěsů Ø35\*

\*Nelze použít pro speciální závěsy se širokým úhlem otevření

## Přibližné množství závesov Ø35\*

\*Nie je možné použiť pre špeciálne závesy so širokým uhlom otvorenia

## Hozzávetőleges mennyiségű pántok Ø35\*

\*Nem alkalmazható speciális széles nyitási szög pántoknál

## Cantitate aproximativă de balamale Ø35\*

\*Nu se aplică balamalelor speciale cu unghi larg de deschidere

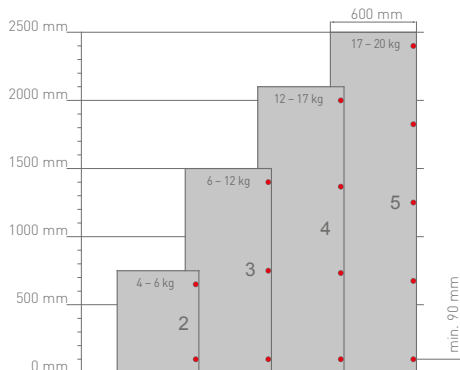

## Přibližné množství závěsů Ø26 a Ø35\*

\*Použit pro speciální závěsy se širokým úhlem otevření

## Přibližné množství závesov Ø26 a Ø35\*

\*Možné použiť pre špeciálne závesy so širokým uhlom otvorenia

## A pántok Ø26 és Ø35 hozzávetőleges mennyisége\*

\*Alkalmazható speciális széles nyitási szög pántoknál

## Cantitate aproximativă de balamale Ø26 și Ø35\*

\*Aplică balamalelor speciale cu unghi larg de deschidere

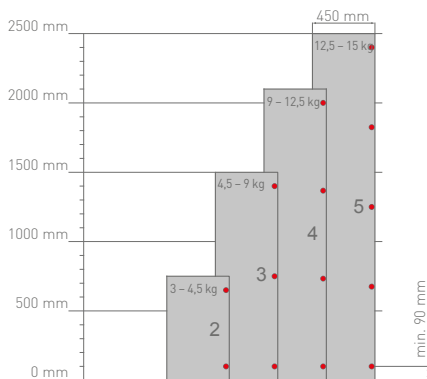

- Počet použitých závěsů závisí na výšce, šířce a hmotnosti dveří.
- Aby byla zajištěna stabilita, vzdálenost mezi závěsy by měla být co největší.
- Před zahájením sériové výroby je třeba provést montážní testy, aby byla zajištěna správná funkce.
- Počet použitých závesov závisí na výšce, šířce a hmotnosti dvierok.
- Aby bola zaistená stabilita, vzdialenosť medzi závesmi by mala byť čo najväčšia.
- Pred zahájením sériové výroby je potrebné vykonať montážne testy, aby bola zaistená správna funkcia.
- A használandó pántok száma függ a panel magasságától, szélességétől és súlyától.
- A stabilitás biztosítása érdekében a pántok közötti távolságnak a lehető legnagyobbnak kell lennie.
- A tömeggyártás megkezdése előtt szerelési próbákat kell végrehajtani a megfelelő működés biztosítása érdekében.
- Numărul de balamale care ar trebui utilizate, depinde de înălțimea, lățimea și greutatea frontului.
- Pentru a asigura stabilitatea, distanța dintre balamale ar trebui să fie cât mai mare posibil.
- Înainte de a începe producția în serie, trebuie efectuate teste de montare pentru a asigura o funcționare corectă.

Mechanismus SoftMove  
 Mechanismus SoftMove  
 SoftMove mechanismus  
 Mecanismul SoftMove

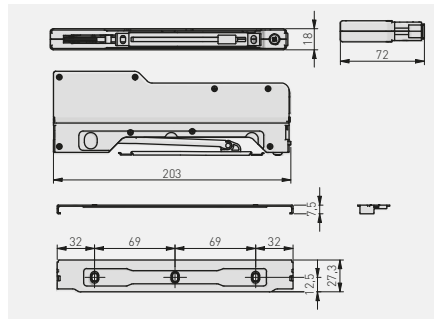

ZM-OT-STANDARD	ocel + plast / ocel + plast / acél + műanyag / oțel + plastic
ZN-OT-HEAVY*	



\*K dispozicii pro speciální objednávky / K dispozícii na špeciálne objednávky / Külön megrendelésben kapható / Disponibil pentru comenzi speciale

Hydraulický miskový závěs SilentoPro s excentrickým nastavením, naložená dvířka  
 Hydraulický miskový záves SilentoPro s excentrickým nastavením, naložený  
 Fékes kivetőpánt SilentoPro excentrikus beállítással, rázáródó  
 Balamale cu amortizare si reglaj excentric SilentoPro aplicate

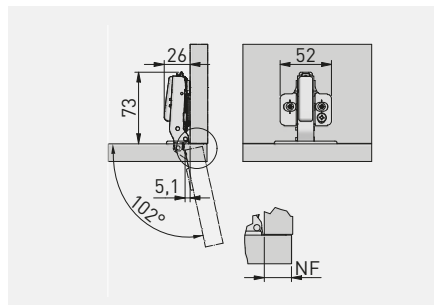

ZM-HCSL09-3D	H = 0	—	—	nikel nikel nikkel nichel	ocel ocel acél oțel
--------------	-------	---	---	------------------------------------	------------------------------

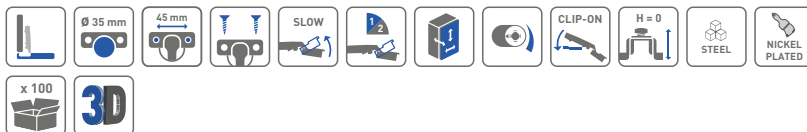

Hydraulický miskový závěs SilentoPro s excentrickým nastavením, polonaložený  
 Hydraulický miskový záves SilentoPro s excentrickým nastavením, polonaložený  
 Fékes kivetőpánt SilentoPro excentrikus beállítással, félig rázáródó  
 Balamale cu amortizare si reglaj excentric SilentoPro semi aplicate

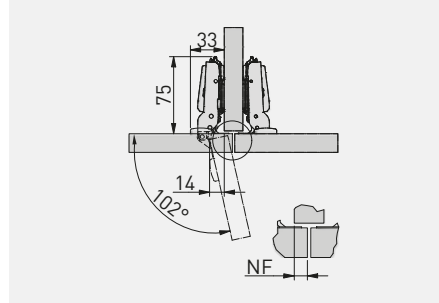

ZM-HCSL08-3D	H = 0	—	—	nikel nikel nikkel nichel	ocel ocel acél oțel

Hydraulický miskový závěs SilentoPro s excentrickým nastavením, vložená dvířka  
 Hydraulický miskový záves SilentoPro s excentrickým nastavením, vložený  
 Fékes kivetőpánt SilentoPro excentrikus beállítással, közé záródó  
 Balamale cu amortizare si reglaj excentric SilentoPro incadrate

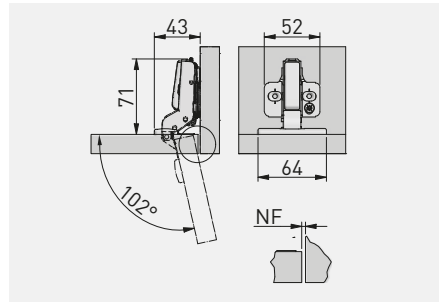

ZM-HCSL07-3D	H = 0	—	—	nikel nikel nikkel nichel	ocel ocel acél oțel



Příslušenství závěsů Silento PRO  
 Příslušenstvo k závesom Silento PRO  
 Kiegészítők a Silento PRO zsanérokhoz  
 Elemente pentru balamale Silento PRO



PZ-HCSL-H0-BE0  
PZ-HCSL-H0-ZE0

Křížová podložka  
Křížová podložka  
Keresztirányú szerelőlap  
Placă de montare în cruce

PZ-HCSL3D-H0-BE0

Podložka s excentrem  
Podložka s excentrem  
Állítható szerelőlap  
Placă de montaj cu reglare

PZ-HCSL-H0-M5

Křížová podložka s hmoždinkami  
Křížová podložka s hmoždinkami  
Keresztirányú szerelőlap + műanyag aljátok  
Placă de montare în cruce + manșetă de plastic

ZM-COVERHCSL-SET

Krytky - sada  
Krytky - sada  
Takarórupak - készlet  
Capace de acoperire - set

PZ-HCSL-H0-BE0	H = 0	—	—	x200	nikel nikel nikkel nikel	ocel ocel acél oțel	
PZ-HCSL-H0-ZE0		—	x2	x200			
PZ-HCSL3D-H0-BE0		—	—	x200			
PZ-HCSL-H0-M5		—	—	x200			
ZM-COVERHCSL-SET		—	—	x1000			

Hydraulický miskový závěs SOLID plus, naložený  
 Hydraulický miskový záves SOLID plus, naložený  
 Fékes kivetőpánt SOLID PLUS, rázáródó  
 Balamale cu amortizare SOLID PLUS aplicate

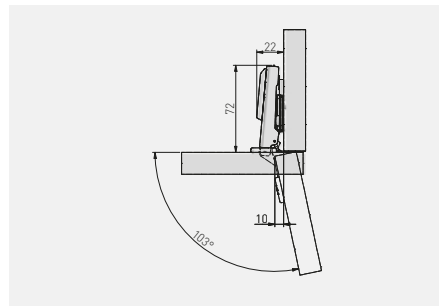

ZM-DCHC09-3DBE0	H = 0	—	—	nikel nikel nikkel nikel	ocel ocel acél oțel	
ZM-DCHC09-3DZE0		—	x 2			



\*K dispozici pro speciální objednávky / K dispozícii na špeciálne objednávky / Külön megrendelésben kapható / Disponibil pentru comenzi speciale

Hydraulický miskový závěs SOLID plus, polonaložený  
 Hydraulický miskový závěs SOLID plus, polonaložený  
 Fékes kivetőpánt SOLID PLUS, félig rázáródó  
 Balamale cu amortizare SOLID PLUS semi aplicate

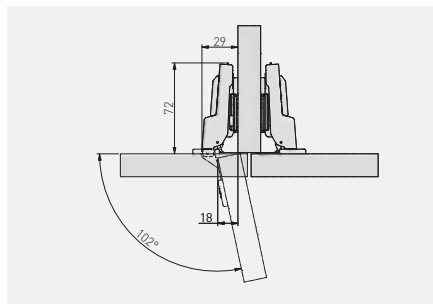

ZM-DCHC08-3DBEO	H = 0	—	—	nikel nikel nikel	ocel ocel ocel
ZM-DCHC08-3DZEO		—	x 2		



\*K dispoziciji pro speciální objednávky / K dispoziciji na speciálne objednávky / Külön megrendelésben kapható / Disponibil pentru comenzi speciale

Miskový závěs s tlumením SOLID PLUS, vložený  
 Hydraulický miskový závěs SOLID plus, vložený  
 Fékes kivetőpánt SOLID plus, közé záródó  
 Balamale cu amortizare SOLID plus incadrate

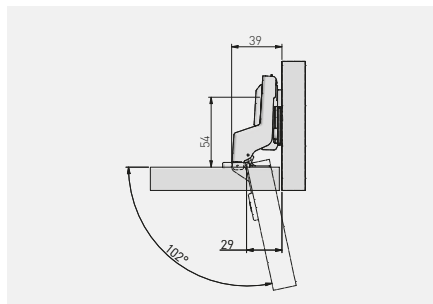

ZM-DCHC07-3DBEO	H = 0	—	—	nikel nikel nikel	ocel ocel ocel
ZM-DCHC07-3DZEO		—	x 2		



\*K dispoziciji pro speciální objednávky / K dispoziciji na speciálne objednávky / Külön megrendelésben kapható / Disponibil pentru comenzi speciale

Miskový záves s tlumením ECHC, naložený  
 Hydraulický miskový záves ECHC, naložený  
 Fékes kivetőpánt ECHC, rázáródó  
 Balamale cu amortizare ECHC aplicate

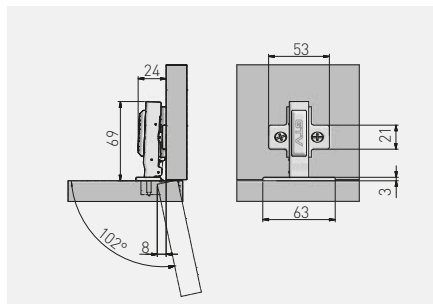

ZM-ECHC09BEO	H = 0	x 4	—	nikel nikel nikkel nichel	ocel ocel acél oțel
ZM-ECHC09ZE0		x 2	x 2		



\*K dispozici pro speciální objednávky / K dispozici na speciálne objednávky / Külön megrendelésben kapható / Disponibil pentru comenzi speciale



Hydraulický miskový závěs ECHC, polonaložený  
 Hydraulický miskový záves ECHC, polonaložený  
 Fékes kivetőpánt ECHC, félg rázáródó  
 Balamale cu amortizare ECHC semi aplicate

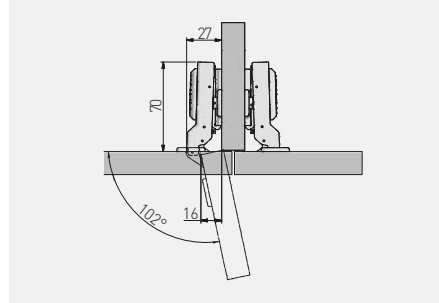

ZM-ECHC08BEO	H = 0	x 4	—	nikel nikel nikkel nichel	ocel ocel acél oțel
ZM-ECHC08ZE0		x 2	x 2		



\*K dispozicii pro speciální objednávky / K dispozicii na špeciálne objednávky / Külön megrendelésben kapható / Disponibil pentru comenzi speciale

Hydraulický miskový závěs ECHC, vložený  
 Hydraulický miskový záves ECHC, vložený  
 Fékes kivetőpánt ECHC, közé záródó  
 Balamale cu amortizare ECHC incadrate

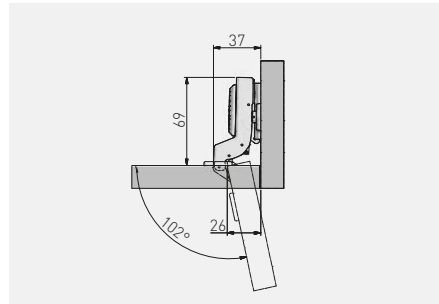

ZM-ECHC07BEO	H = 0	x 4	—	nikel nikel nikkel nichel	ocel ocel acél oțel
ZM-ECHC07ZE0		x 2	x 2		



\*K dispozicii pro speciální objednávky / K dispozicii na špeciálne objednávky / Külön megrendelésben kapható / Disponibil pentru comenzi speciale

Hydraulický miskový závěs ECHC, naložený  
 Hydraulický miskový záves ECHC, naložený  
 Fékes kivetőpánt ECHC, rázáródó  
 Balamale cu amortizare ECHC aplicate

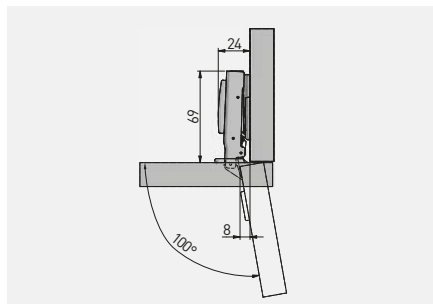

ZM-ECHC09H04-BE	H = 0	x 6	—	nikel nikel nikkel nichel	ocel ocel acél oțel



\*K dispozicii pro speciální objednávky / K dispozícii na špeciálne objednávky / Külön megrendelésben kapható / Disponibil pentru comenzi speciale

Hydraulický miskový závěs ECHC, polonaložený  
 Hydraulický miskový záves ECHC, polonaložený  
 Fékes kivetőpánt ECHC, félig rázáródó  
 Balamale cu amortizare ECHC semi aplicate

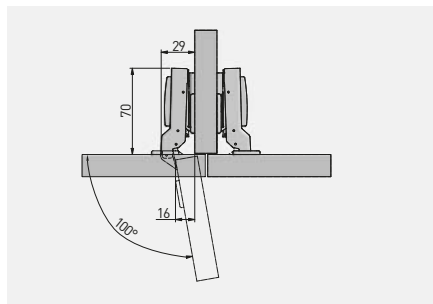

ZM-ECHC08H04-BE	H = 0	x 6	—	nikel nikel nikkel nichel	ocel ocel acél oțel



\*K dispozicii pro speciální objednávky / K dispozícii na špeciálne objednávky / Külön megrendelésben kapható / Disponibil pentru comenzi speciale

Hydraulický miskový závěs ECHC, vložený  
 Hydraulický miskový záves ECHC, vložený  
 Fékes kivetőpánt ECHC, közzé záródó  
 Balamale cu amortizare ECHC încadrate

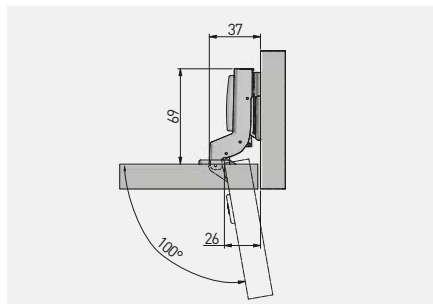

ZM-ECHC07H04-BE	H = 0	x 6	—	nikel nikel nikkel nichel	ocel ocel acél oțel



\*K dispozici pro speciální objednávky / K dispozici na špeciálne objednávky / Külön megrendelésben kapható / Disponibil pentru comenzi speciale

Hydraulický miskový závěs ECHC3D s excentrickým nastavením, naložený  
 Hydraulický miskový záves ECHC3D s excentrickým nastavením, naložený  
 Fékes kivetőpánt ECHC3D excenteres beállítással, rázáródó  
 Balamale cu amortizare si reglaj excentric ECHC3D aplicate

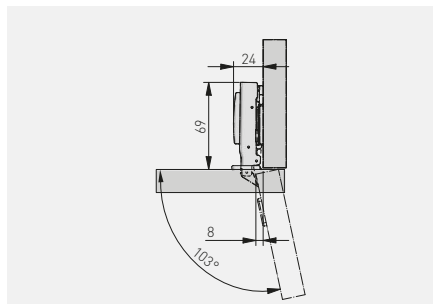

ZM-ECHC09-3DBEO	H = 0	x 4	—	nikel nikel nikkel nichel	ocel ocel acél oțel



\*K dispozici pro speciální objednávky / K dispozici na špeciálne objednávky / Külön megrendelésben kapható / Disponibil pentru comenzi speciale

Hydraulický miskový závěs ECHC3D s excentrickým nastavením, polonaložený  
 Hydraulický miskový záves ECHC3D s excentrickým nastavením, polonaložený  
 Fékes kivetópánt ECHC3D excentrikus beállítással, félig rázáródó  
 Balamale cu amortizare si reglaj excentric ECHC3D semi aplicate

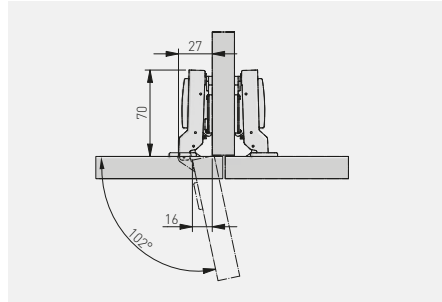

ZM-ECHC08-3DBE0	H = 0	x 4	—	nikel nikel nikkel nichel	ocel ocel acél oțel



\*K dispozici pro speciální objednávky / K dispozici na speciálne objednávky / Külön megrendelésben kapható / Disponibil pentru comenzi speciale

Hydraulický miskový závěs ECHC3D s excentrickým nastavením, vložený  
 Hydraulický miskový záves ECHC3D s excentrickým nastavením, vložený  
 Fékes kivetópánt ECHC3D excentrikus beállítással, kőzé záródó  
 Balamale cu amortizare si reglaj excentric ECHC3D incadrate

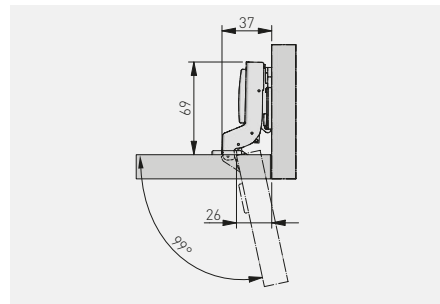

ZM-ECHC07-3DBE0	H = 0	x 4	—	nikel nikel nikkel nichel	ocel ocel acél oțel



\*K dispozici pro speciální objednávky / K dispozici na speciálne objednávky / Külön megrendelésben kapható / Disponibil pentru comenzi speciale

Hydraulický miskový závěs CNHC s excentrickým nastavením, naložená dvířka  
 Hydraulický miskový závěs CNHC s excentrickým nastavením, naložený  
 Fékes kivetőpánt CNHC excentrikus beállítással, rázáródó  
 Balamale cu amortizare si reglaj excentric CNHC aplicate

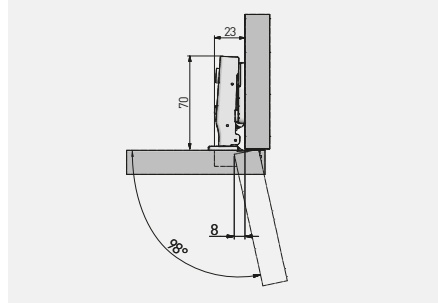

ZM-CNHC09BR2	H = 0	-	-	nikl nikel nikkel nichel	ocel ocel acél ojet



Hydraulický miskový závěs CNHC s excentrickým nastavením, dvojitá naložená dvířka  
 Hydraulický miskový závěs CNHC s excentrickým nastavením, polonaložený  
 Fékes kivetőpánt CNHC excentrikus beállítással, félig rázáródó  
 Balamale cu amortizare si reglaj excentric CNHC semi aplicate

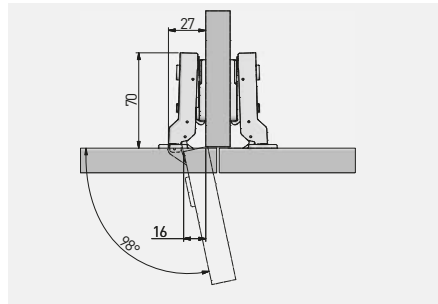

ZM-CNHC08BR2	H = 0	-	-	nikl nikel nikkel nichel	ocel ocel acél ojet





Hydraulický miskový závěs CNHC s excentrickým nastavením, vložená dvířka  
 Hydraulický miskový závěs CNHC s excentrickým nastavením, vložený  
 Fékes kivetőpánt CNHC excentrikus beállítással, közés záródó  
 Balamale cu amortizare si reglaj excentric CNHC incadrate

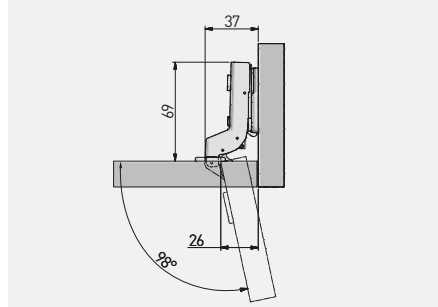

ZM-CNHC07BR2	H = 0	-	-	nikel nikel nikkel nichel	ocel ocel acél oțel



Hydraulický miskový závěs INHC, naložená dvířka  
 Hydraulický miskový závěs INHC, naložený  
 Fékes kivetőpánt INHC, rázáródó  
 Balamale cu amortizare INHC aplicate

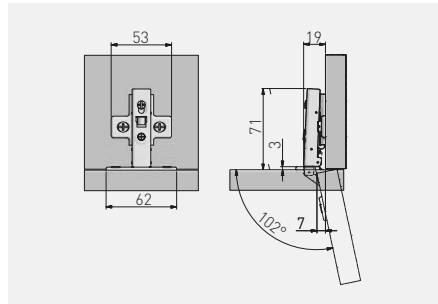

ZM-INHC090BEO	H = 0	-	-	nikel nikel nikkel nichel	ocel ocel acél oțel
ZM-INHC090ZEO		-	x 2		



Hydraulický miskový závěs INHC, polonaložená dvířka  
 Hydraulický miskový záves INHC, polonaložený  
 Fékes kivetőpánt INHC, félig rázáródó  
 Balamale cu amortizare INHC semi aplicate

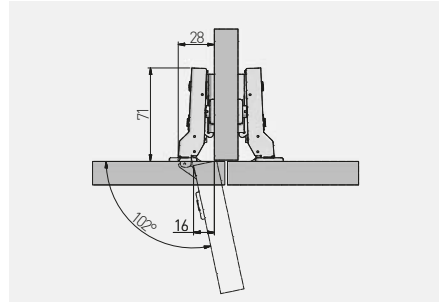

ZM-INHC080BEO	H = 0	—	—	x 2	nikel nikel nikkel nichel	ocel ocel acél oțel	
ZM-INHC080ZEO		—	—				



\*K dispozici pro speciální objednávky / K dispozicii na speciálne objednávky / Külön megrendelésben kapható / Disponibil pentru comenzi speciale

Hydraulický miskový závěs INHC, vložená dvířka  
 Hydraulický miskový záves INHC, vložený  
 Fékes kivetőpánt INHC, közé záródó  
 Balamale cu amortizare INHC incadrate

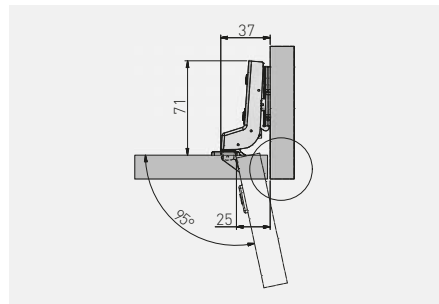

ZM-INHC070BEO	H = 0	—	—	x 2	nikel nikel nikkel nichel	ocel ocel acél oțel	
ZM-INHC070ZEO		—	—				



\*K dispozici pro speciální objednávky / K dispozicii na speciálne objednávky / Külön megrendelésben kapható / Disponibil pentru comenzi speciale

Hydraulický úhlový miskový závěs 30° HCKT  
 Hydraulický uhlový miskový záves 30° HCKT  
 Fékes sarokpánt 30° HCKT  
 Balamale cu amortizare 30° HCKT

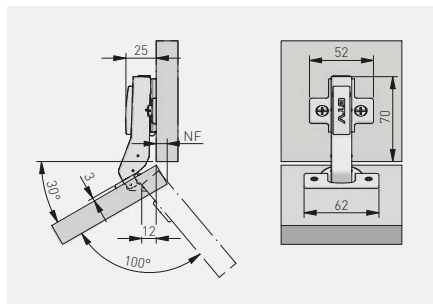

ZM-HCKT30-BE-S	H = 0	x 4	—	nikel nikel nikkel nichel	ocel ocel acél otél
ZM-HCKT30-ZE-S		x 2	x 2		



\*K dispozici pro speciální objednávky / K dispozícii na špeciálne objednávky / Külön megrendelésben kapható / Disponibil pentru comenzi speciale

Hydraulický úhlový miskový závěs 45° HCKT  
 Hydraulický rohový miskový záves 45° HCKT  
 Fékes sarokpánt 45° HCKT  
 Balamale cu amortizare 45° HCKT

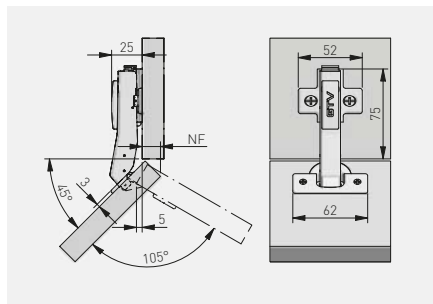

ZM-HCKT45-BE-S	H = 0	x 4	—	nikel nikel nikkel nichel	ocel ocel acél otél
ZM-HCKT45-ZE-S		x 2	x 2		



\*K dispozici pro speciální objednávky / K dispozícii na špeciálne objednávky / Külön megrendelésben kapható / Disponibil pentru comenzi speciale

Úhlový závěs 45° HCKT s excentrickým nastavením  
 Ughový záves 45° HCKT s excentrickým nastavením  
 Fékes sarokpánt 45° HCKT excentrikus beállítással  
 Balamale cu amortizare 45° HCKT cu reglaj excentric

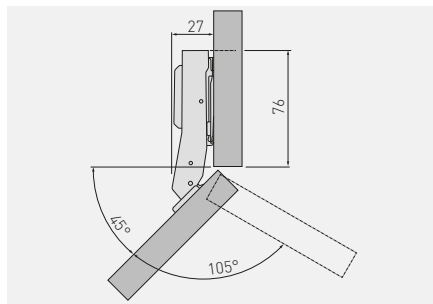

ZM-HCKT45-3DBEO-S	H = 0	x 4	—	nikl nikel nikkel nichel	ocel ocel acél oțel



\*K dispozici pro speciální objednávky / K dispoziciji na špeciálne objednávky / Külön megrendelésben kapható / Disponibil pentru comenzi speciale

Příložný hydraulický závěs HCKT  
 Paralelný hydraulický záves HCKT  
 Párhuzamos fékes sarokpánt HCKT  
 Balamale cu amortizare 90° HCKT

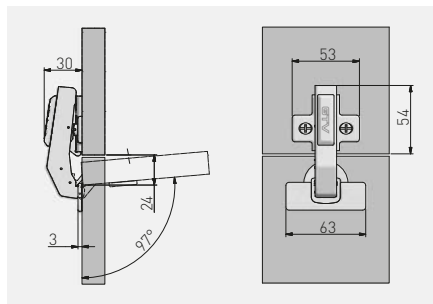

ZM-HCKT90-BE-S	H = 0	x 4	—	nikl nikel nikkel nichel	ocel ocel acél oțel
ZM-HCKT90-ZE-S		x 2	x 2		



\*K dispozici pro speciální objednávky / K dispoziciji na špeciálne objednávky / Külön megrendelésben kapható / Disponibil pentru comenzi speciale

Příložný závěs HCKT s excentrickým nastavením  
 Paralelný závěs HCKT s excentrickým nastavením  
 Fékes sarokpánt HCKT excentrikus beállítással  
 Balamale cu amortizare 90° HCKT cu reglaj excentric

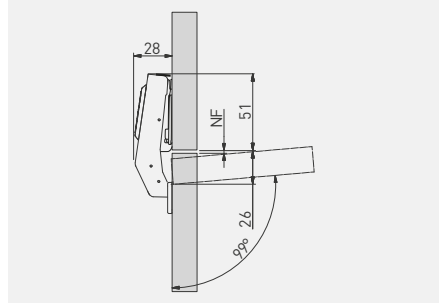

ZM-HCKT90-3DBEO-S	H = 0	x 4	—	nikel nikel nikkel nichel	ocel ocel acél otel



\*K dispozici pro speciální objednávky / K dispozícii na špeciálne objednávky / Külön megrendelésben kapható / Disponibil pentru comenzi speciale

Paralelní pant – krátké rameno s pružinou KT  
 Rovnožečný pán – krátke rameno s prítlačnou pružinou KT  
 Párhuzamos zsanér - rövid kar KT szorítórugóval  
 Balamale paralelă - braț scurt cu arc de tracțiune KT

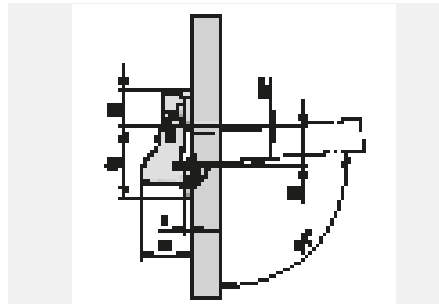

ZM-HCKTK90-ZE	H = 0	x 2	—	nikel nikel nikkel nichel	ocel ocel acél otel



Hydraulický odsazený závěs 155° HCKT  
 Hydraulický odsadený záves 155° HCKT  
 Fékes sarokpánt 155° HCKT  
 Balamale cu amortizare 155° HCKT

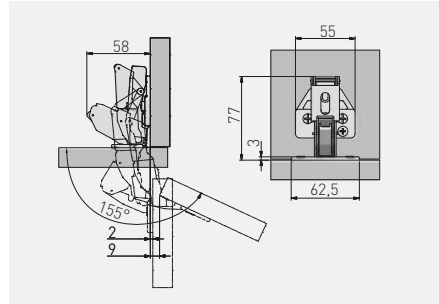

ZM-HCKT155BE	H = 0	—	—	nikel nikel nikkel nichel	ocel ocel acél oțel
ZM-HCKT155ZE		—	x 2		



\*K dispozici pro speciální objednávky / K dispozici na špeciálne objednávky / Külön megrendelésben kapható / Disponibil pentru comenzi speciale

Hydraulický závěs 165° HCKT  
 Hydraulický záves 165° HCKT  
 Fékes sarokpánt 165° HCKT  
 Balamale cu amortizare 165° HCKT

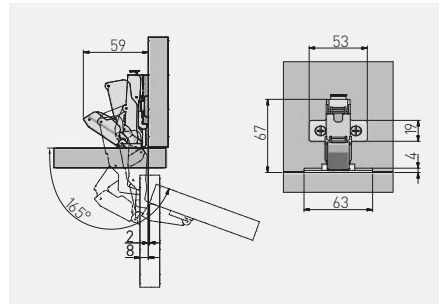

ZM-HCKT165BE-S	H = 0	—	—	nikel nikel nikkel nichel	ocel ocel acél oțel
ZM-HCKT165ZE-S		—	x 2		



\*K dispozici pro speciální objednávky / K dispozici na špeciálne objednávky / Külön megrendelésben kapható / Disponibil pentru comenzi speciale

Hydraulický závěs 165° HCKT s excentrickým nastavením  
 Hydraulický záves 165° HCKT s excentrickým nastavením  
 Fékes sarokpánt 165° HCKT excentrikus beállítással  
 Balamale cu amortizare 165° HCKT cu reglaj excentric

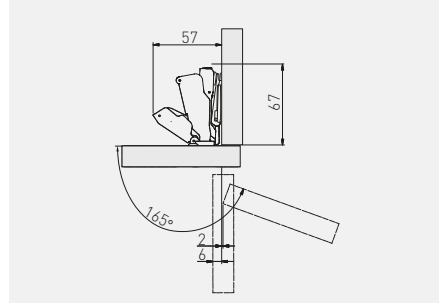

ZM-HCKT165-3DBEO-S	H = 0	—	—	nikel nikel nikkel nichel	ocel ocel acél oțel

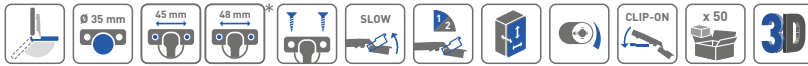

\*K dispozici pro speciální objednávky / K dispozici na speciálne objednávky / Külön megrendelésben kapható / Disponibil pentru comenzi speciale

Závěs SOLID, naložená dvířka  
 Záves SOLID, naložené dvierka  
 Kivetőpánt SOLID, rázáródó  
 Balamale SOLID, aplicate

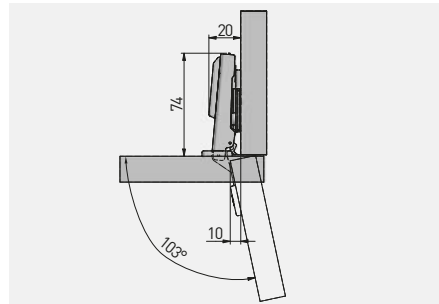

ZP-BIDI09-3DBEO	H = 0	—	—	nikel nikel nikkel nichel	ocel ocel acél oțel



\*K dispozici pro speciální objednávky / K dispozici na speciálne objednávky / Külön megrendelésben kapható / Disponibil pentru comenzi speciale

Závěs SOLID, polonaložená dvířka  
 Záves SOLID, polonaložené dverka  
 Kivetőpánt SOLID, félig rázáródó  
 Balamale SOLID, semiaplicate

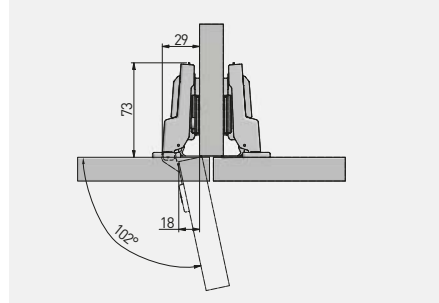

ZP-BIDI08-3DBEO	H = 0	—	—	nikel nikel nikkel nichel	ocel ocel acél oțel



\*K dispozici pro speciální objednávky / K dispozici na špeciálne objednávky / Külön megrendelésben kapható / Disponibil pentru comenzi speciale

Závěs SOLID, vložená dvířka  
 Záves SOLID, vložné dverka  
 Kivetőpánt SOLID, kőzé záródó  
 Balamale SOLID, incadrate

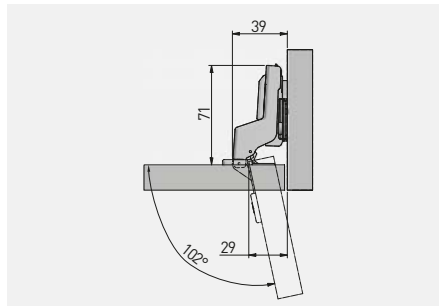

ZP-BIDI07-3DBEO	H = 0	—	—	nikel nikel nikkel nichel	ocel ocel acél oțel



\*K dispozici pro speciální objednávky / K dispozici na špeciálne objednávky / Külön megrendelésben kapható / Disponibil pentru comenzi speciale



Závěs CONL, naložená dvířka  
 Záves CONL, naložené dvierka  
 Kivetőpánt CONL, rázáródó  
 Balamale CONL, aplicate

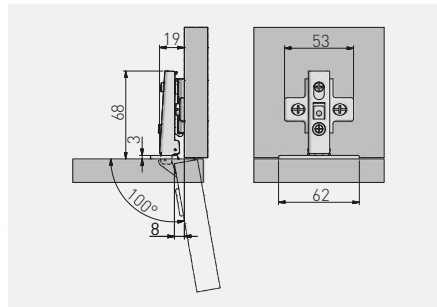

ZP-CONL09-BE	H = 0	—	—	nikel nikel nikkel nichel	ocel ocel acél oțel
ZP-CONL09-ZE		—	x 2		



\*K dispozici pro speciální objednávky / K dispozici na speciálne objednávky / Külön megrendelésben kapható / Disponibil pentru comenzi speciale

Závěs CONL, polonaložená dvířka  
 Záves CONL, polonaložený dvierka  
 Kivetőpánt CONL, félig rázáródó  
 Balamale CONL, semiaplicat

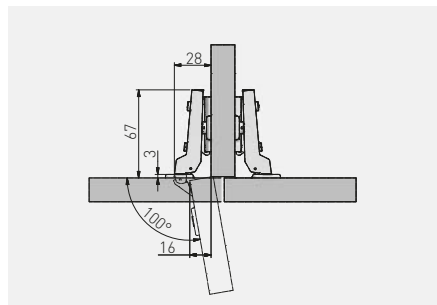

ZP-CONL08-BE	H = 0	—	—	nikel nikel nikkel nichel	ocel ocel acél oțel
ZP-CONL08-ZE		—	x 2		



\*K dispozici pro speciální objednávky / K dispozici na speciálne objednávky / Külön megrendelésben kapható / Disponibil pentru comenzi speciale

Závěs CONL, vložená dvířka  
 Záves CONL, vložený dverka  
 Kivetőpánt CONL, közzé záródó  
 Balamale CONL, incadrate

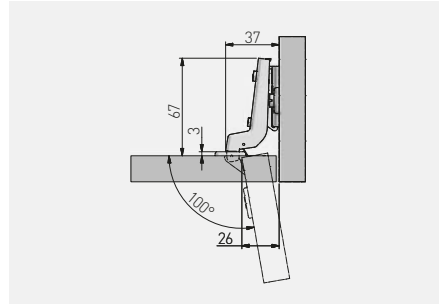

ZP-CONL07-BE	H = 0	—	—	nikel nikel nikkel nichel	ocel ocel acél oțel
ZP-CONL07-ZE		—	x 2		



\*K dispoziciji pro speciální objednávky / K dispoziciji na špeciálne objednávky / Külön megrendelésben kapható / Disponibil pentru comenzi speciale

Závěs BICN, naložená dvířka  
 Záves BICN, naložené dverka  
 Kivetőpánt BICN, rázáródó  
 Balamale BICN, aplicata

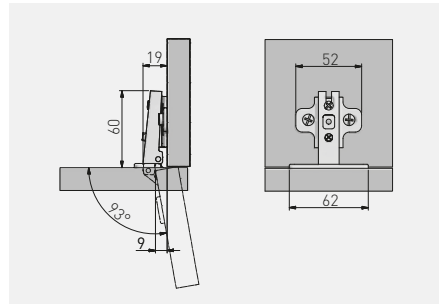

ZP-BICN090BE	H = 0	—	—	nikel nikel nikkel nichel	ocel ocel acél oțel
ZP-BICN090ZE		—	x 2		
ZP-BICN092BE	H = 2	—	—	nikel nikel nikkel nichel	ocel ocel acél oțel
ZP-BICN092ZE		—	x 2		



\*K dispoziciji pro speciální objednávky / K dispoziciji na špeciálne objednávky / Külön megrendelésben kapható / Disponibil pentru comenzi speciale

Závěs BICN, polonaložená dvířka  
 Záves BICN, polonaložená dvierka  
 Kivetőpánt BICN, félig rázáródó  
 Balamale BICN, semiaplicate

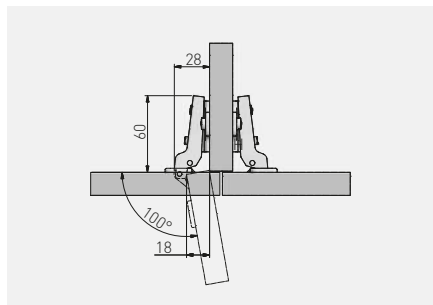

ZP-BICN080BE	H = 0	—	—	nikel nikel nikkel nichel	ocel ocel acél oțel		
ZP-BICN080ZE		—	x 2				
ZP-BICN082BE	H = 2	—	—				
ZP-BICN082ZE		—	x 2				



\*K dispozícii pro speciální objednávky / K dispozícii na špeciálne objednávky / Külön megrendelésben kapható / Disponibil pentru comenzi speciale

Závěs BICN, vložná dvířka  
 Záves BICN, vložný dvierka  
 Kivetőpánt BICN, közé záródó  
 Balamale BICN, incadrate

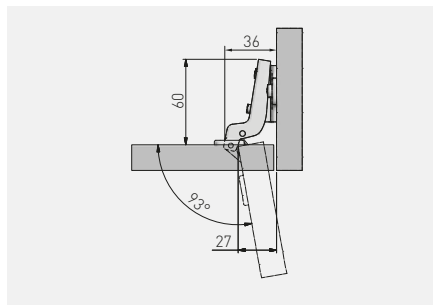

ZP-BICN070BE	H = 0	—	—	nikel nikel nikkel nichel	ocel ocel acél oțel		
ZP-BICN070ZE		—	x 2				
ZP-BICN072BE	H = 2	—	—				
ZP-BICN072ZE		—	x 2				



\*K dispozícii pro speciální objednávky / K dispozícii na špeciálne objednávky / Külön megrendelésben kapható / Disponibil pentru comenzi speciale

Závěs BICJ-B, naložená dvířka  
 Záves BICJ-B, naložené dverka  
 Kivetőpánt BICJ-B, rázáródó  
 Balamale BICJ-B, aplicate

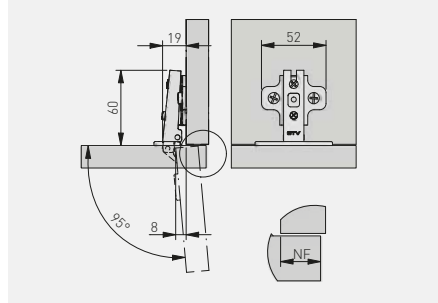

ZP-BICJ290ZE-B	H = 0	—	x 2	nikel nikel nikkel nichel	ocel ocel acél otjel
ZP-BICJ090ZE-B	H = 2	—	x 2		



Závěs BICJ-B, polonaložená dvířka  
 Záves BICJ-B, polonaložená dverka  
 Kivetőpánt BICJ-B, félig rázáródó  
 Balamale BICJ-B, semiaclicate

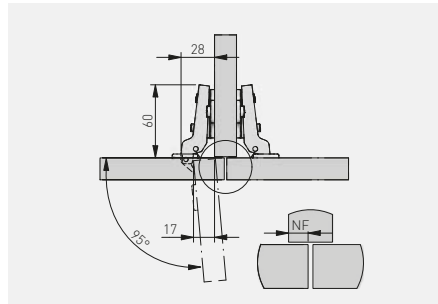

ZP-BICJ080ZE-B	H = 0	—	x 2	nikel nikel nikkel nichel	ocel ocel acél otjel
ZP-BICJ280ZE-B	H = 2	—	x 2		



Závěs BICJ-B, vložená dvířka  
 Záves BICJ-B, vložený dvierka  
 Kivetőpánt BICJ-B, közé záródó  
 Balamale BICJ-B, incadrate

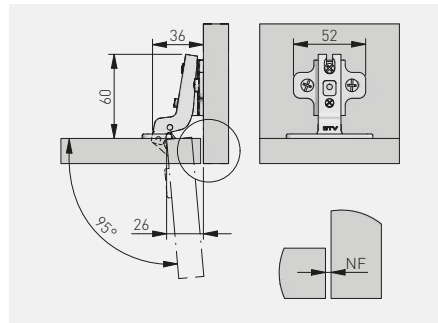

ZP-BICJ070ZE-B	H = 0	—	x 2	nikel nikel nikel	ocel ocel ocel
ZP-BICJ270ZE-B	H = 2	—	x 2		



Omezovač úhlu otevření závěsu  
 Obmedzovač uhla otvorenia závesu  
 Nyitásszög-határoló a zsanérhoz  
 Limitator de unghi de deschidere pentru balama

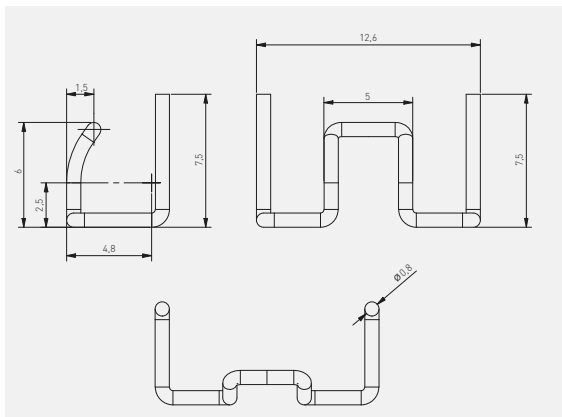
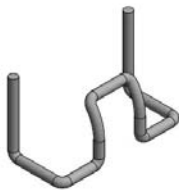

Z-OGK-KAT	ocel ocel acél ocel

Úhlový závěs 30° KT  
 Uhlvový záves 30° KT  
 Sarokpánt 30° KT  
 Balamale 30° KT

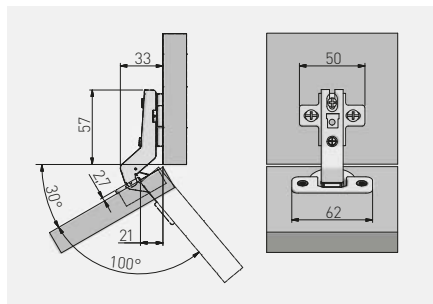

ZP-KT30H2-BE	H = 2	—	—	nikel nikel nikel nichel	ocel ocel acél oţel



Úhlový závěs 45° KT  
 Uhlvový záves 45° KT  
 Sarokpánt 45° KT  
 Balamale 45° KT

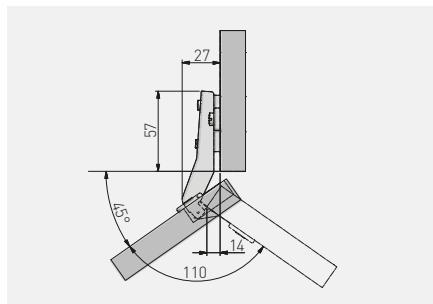

ZP-KT45H2-BE	H = 2	—	—	nikel nikel nikel nichel	ocel ocel acél oţel
ZP-KT45H2-ZE		—	x 2		



Příložný závěs KT  
 Paralelný závěs KT  
 Párhuzamos kivetópánt KT  
 Balamale 90° KT

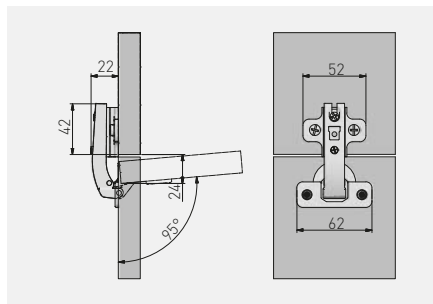

ZP-KT90H2-BE	H = 2	—	—	nikel nikkel nichel	ocel ocel acél oțel
ZP-KT90H2-ZE		—	x 2		



Příložný závěs – krátké rameno KTK  
 Paralelný závěs – krátké rameno KTK  
 Párhuzamos kivetópánt - rövid kar KTK  
 Balamale 90° braț scurt KTK

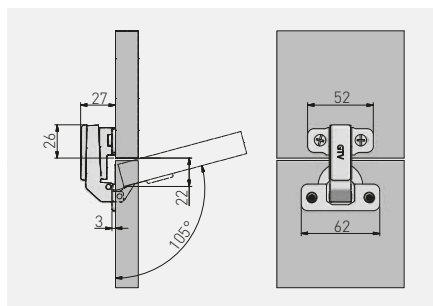

ZP-KTK90H6BE	H = 6	—	—	nikel nikkel nichel	ocel ocel acél oțel
ZP-KTK90H6ZE		—	x 2		



Závěs 165° KT  
 Záves 165° KT  
 Sarokpánt 165° KT  
 Balamale 165° KT

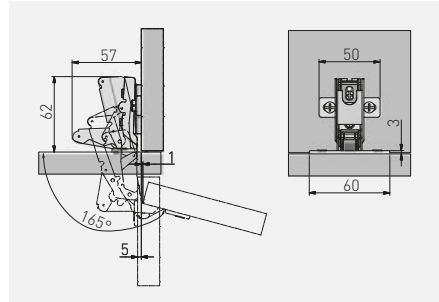

ZP-KT165H2BE	H = 2	—	—	nikel nikel nikel nichel	ocel ocel ocel ocel
ZP-KT165H2ZE		—	x 2		



Doplňkový závěs 135° KT  
 Doplnkový záves 135° KT  
 Sarokpánt 135° KT  
 Balamale 135° KT

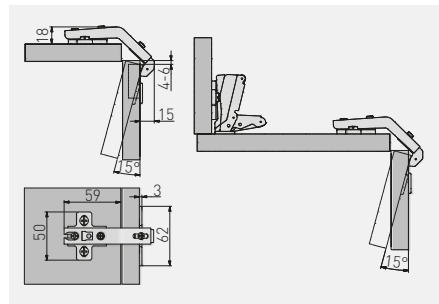

ZP-KT135H2BE	H = 2	—	—	nikel nikel nikel nichel	ocel ocel ocel ocel
ZP-KT135H2ZE		—	x 2		





Závěs bez pružiny COCA, naložená dvířka  
 Závěs bez pružiny COCA, naložené dverčka  
 Kivetőpánt rugó nélküli COCA, rázáródó  
 Balamale fără arc COCA, aplicate

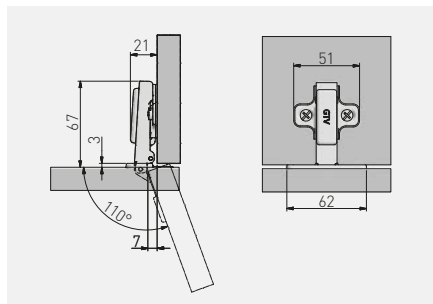

ZP-COCA450-BE	H = 0	—	—	nikel nikel nikkel nichel	ocel ocel acel oțel
ZP-COCA450-ZE		—	x 2		



Závěs bez pružiny COCA, polonaložená dvířka  
 Závěs bez pružiny COCA, polonaložená dverčka  
 Kivetőpánt rugó nélküli COCA, félig rázáródó  
 Balamale fără arc COCA, semiaplicate

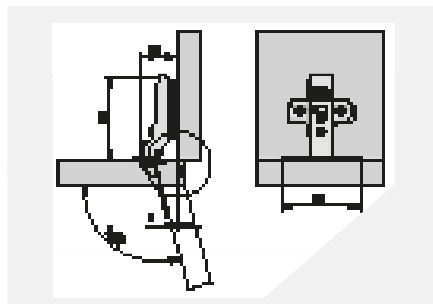

ZP-COCA8450-BE	H = 0	—	—	nikel nikel nikkel nichel	ocel ocel acel oțel



Závěs bez pružiny COCA, vložená dvířka  
 Závés bez pružiny COCA, vložené dvierka  
 Kivetőpánt rugó nélküli COCA, közé záródó  
 Balamale fără arc COCA, incadrate

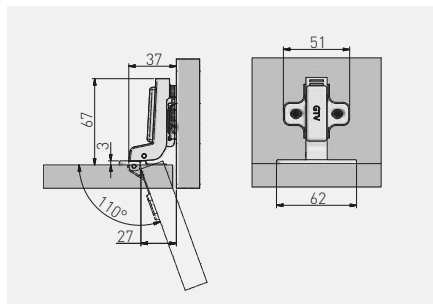

ZP-COCA7450-BE	H = 0	—	—	nikel nikel nikkel nichel	ocel ocel acél oțel



Závěs bez pružiny COCA, naložená dvířka  
 Závés bez pružiny COCA, naložené dvierka  
 Kivetőpánt rugó nélküli COCA, rázáródó  
 Balamale fără arc COCA, aplicate

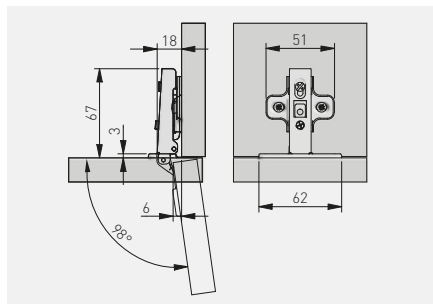

ZP-COCA450-BE-F	H = 0	—	—	nikel nikel nikkel nichel	ocel ocel acél oțel



Závěs bez pružiny COCA, polonaložená dvířka  
 Závés bez pružiny COCA, polonaložená dverka  
 Kivetőpánt rugó nélküli COCA, félig rázáródó  
 Balamale fără arc COCA, semiaplicat

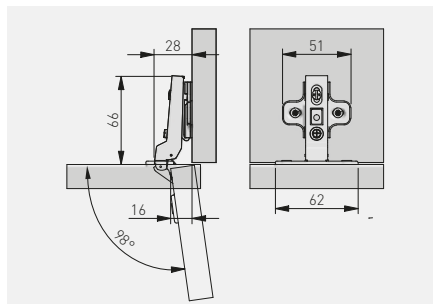

ZP-COCA8450-BE-F	H = 0	—	—	nikel nikel nikkel nichel	ocel ocel acél oțel



Závěs bez pružiny COCA, vložená dvířka  
 Závés bez pružiny COCA, vložené dverka  
 Kivetőpánt rugó nélküli COCA, közé záródó  
 Balamale fără arc COCA, incadrate

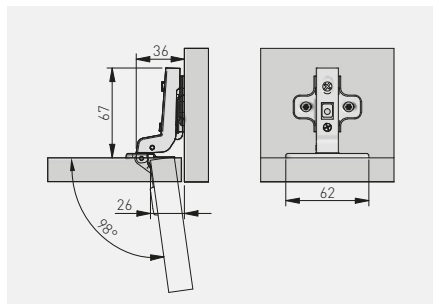

ZP-COCA7450-BE-F	H = 0	—	—	nikel nikel nikkel nichel	ocel ocel acél oțel



Samozavírací záves PO, naložená dvířka  
 Samozatvárací záves PO, naložené dverierka  
 Önnnyíló kivetőpánt push2open, rázáródó  
 Balamale cu push2open, aplicate

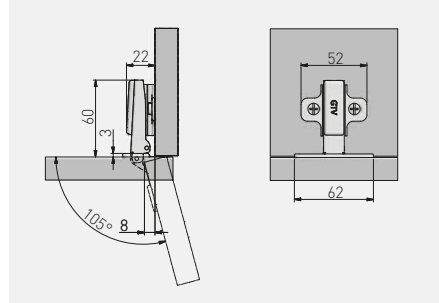

ZP-POH045BEO	H = 0	—	—	nikel nikel nikkel	ocel ocel acél oțel
ZP-POH045ZEO		—	x 2		



Samozavírací záves PO, vložená dvířka  
 Samozatvárací záves PO, vložené dverierka  
 Önnnyíló kivetőpánt push2open, kőzé záródó  
 Balamale cu push2open, incadrate

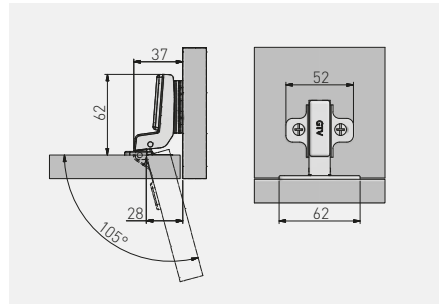

ZP-PO7H045BE	H = 0	—	—	nikel nikel nikkel	ocel ocel acél oțel



Hydraulický záves mini CIHC, naložená dvířka  
 Hydraulický záves mini CIHC, naložené dverka  
 Fékes kivetőpánt mini CIHC, rázáródó  
 Balamale cu frana, mini CIHC, aplicate

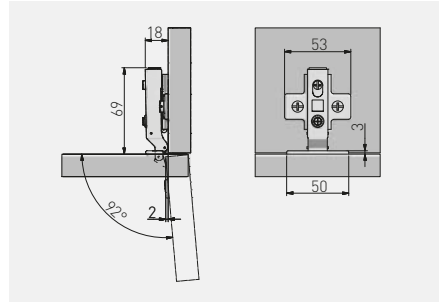

ZP-CIHC090ZE	H = 0	x 2	x 2	nikel nikel nikkel nichel	ocel + ZnAl, ocel + ZnAl, acél + ZnAl, oțel + ZnAl



Hydraulický záves mini CIHC, polonaložená dvířka  
 Hydraulický záves mini CIHC, polonaložené dverka  
 Fékes kivetőpánt mini CIHC, félig rázáródó  
 Balamale cu frana, mini CIHC, semiaplicate

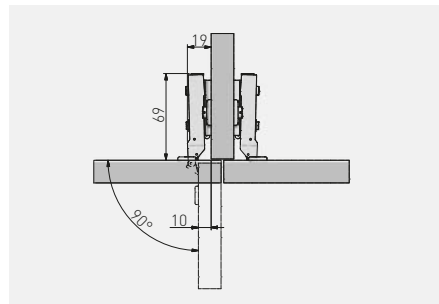

ZP-CIHC080ZE	H = 0	x 2	x 2	nikel nikel nikkel nichel	ocel + ZnAl, ocel + ZnAl, acél + ZnAl, oțel + ZnAl



Hydraulický záves mini CIHC, vložená dvířka  
 Hydraulický záves mini CIHC, vložené dverka  
 Fékes kivetőpánt mini CIHC, közzé záródó  
 Balamale cu frana, mini CIHC, incadrate

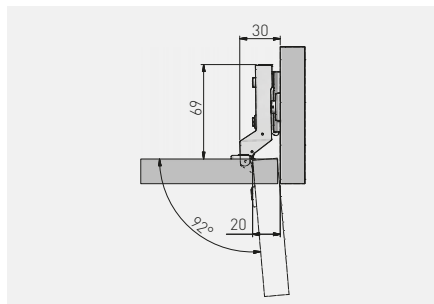

ZP-CIHC070ZE	H = 0	x 2	x 2	nikl nikel nikkel nichel	ocel + ZnAl, ocel + ZnAl, acél + ZnAl, oțel + ZnAl



Záves mini CIBI, naložená dvířka  
 Záves mini CIBI, naložené dverka  
 Kivetőpánt mini CIBI, rázáródó  
 Balamale mini CIBI, aplicare

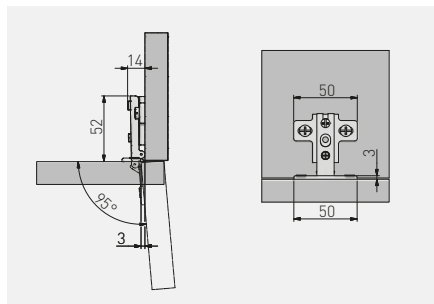

ZP-CIBI9H0ZE	H = 0	-	x 2	nikl nikel nikkel nichel	ocel ocel acél oțel



Závěs mini CIBI, polonaložená dvířka  
 Záves mini CIBI, polonaložené dvierka  
 Kivetőpánt mini CIBI, félig rázáródó  
 Balamale mini CIBI, semiacplicate

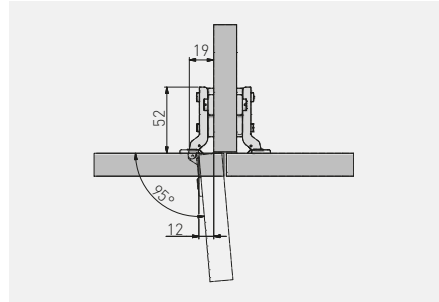

ZP-CIBI8H0ZE	H = 0	-	x 2	nikel nikel nichel	ocel ocel acél oţel



Závěs mini CIBI, vložená dvířka  
 Záves mini CIBI, vložené dvierka  
 Kivetőpánt mini CIBI, közé záródó  
 Balamale mini CIBI, incadrate

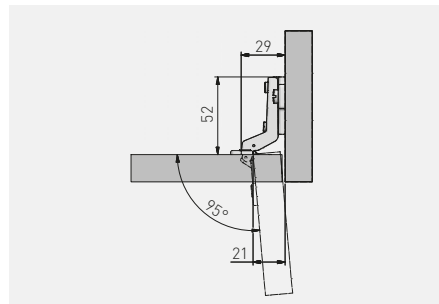

ZP-CIBI7H0ZE	H = 0	-	x 2	nikel nikel nichel	ocel ocel acél oţel



Závěs na sklo CIG, naložená dvířka  
 Záves na sklo CIG, naložené dvierka  
 Kivetőpánt üveghez, rázáródó  
 Balamale pentru sticlă CIG, aplicate

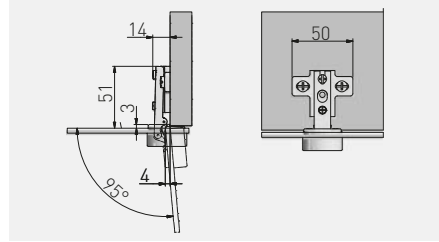

ZP-CIG-090ZE	H = 0	—	x 2	nikel nikel nikkel nichel	ocel + plast, ocel + plast, acél + műanyag, oţel + plastic		chrom, chróm, króm, crom	
ZP-CIG-09UZE		—	x 2					
ZP-CIG-09UBE		—	—				černá / čierna / fekete / negru	
ZP-CIG-09UZC		—	x 2					
ZP-CIG-190ZE		—	x 2					hliník / hliník / aluminium / aluminiumu
ZP-CIG-19UZE	—	x 2						



Závěs na sklo CIG, vložená dvířka  
 Záves na sklo CIG, vložené dvierka  
 Kivetőpánt üveghez, kőzé záródó  
 Balamale pentru sticlă CIG, încadrate

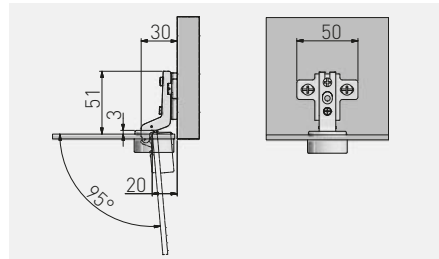

ZP-CIG-070ZE	H = 0	—	x 2	nikel nikel nikkel nichel	ocel + plast, ocel + plast, acél + műanyag, oţel + plastic		chrom, chróm, króm, crom	
ZP-CIG-07UZE		—	x 2					
ZP-CIG-170ZE		—	x 2				hliník, hliník, aluminium, aluminiumu	
ZP-CIG-17UZE		—	x 2					





Závěs pro hliníková dvířka, naložený  
 Záves pre hliníkové dverka, naložený  
 Kivetőpánt alumínium kerethez, rázáródó  
 Balamale pentru cadre din aluminiu, aplicate

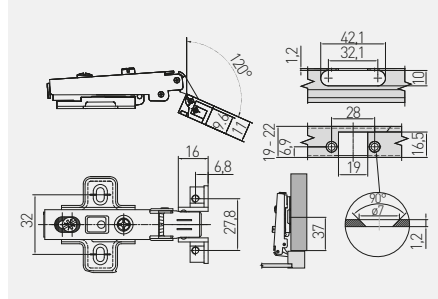

Produkt kompatibilní s hliníkovým profilem pro přední stranu: PA-3731-35-50  
 Produkt kompatibilný s hliníkovým profilem pre prednú stranu: PA-3731-35-50  
 A termék kompatibilis az alumínium profilos panelekhez: PA-3731-35-50  
 Produs compatibil cu profilul din aluminiu pentru fronturi: PA-3731-35-50

ZP-RALUH2-00	H = 2	—	—	nikel nikel nikel	ocel ocel acél oțel

Závěs pro hliníková dvířka, naložený  
 Záves pre hliníkové dverka, naložený  
 Kivetőpánt fékes, alumínium kerethez, rázáródó  
 Balamale cu amortizare pentru cadre din aluminiu, aplicate

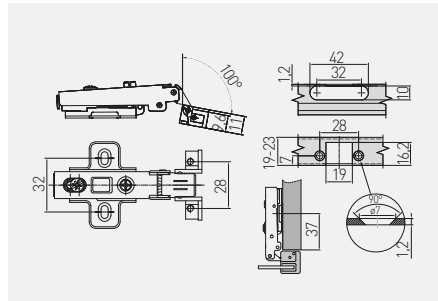

Produkt kompatibilní s hliníkovým profilem pro přední stranu: PA-3731-35-50  
 Produkt kompatibilný s hliníkovým profilem pre prednú stranu: PA-3731-35-50  
 A termék kompatibilis az alumínium profilos panelekhez: PA-3731-35-50  
 Produs compatibil cu profilul din aluminiu pentru fronturi: PA-3731-35-50

ZM-HCRALU9BE	H = 0	—	—	nikel nikel nikel	ocel ocel acél oțel

Závěs 270°, naložená dvířka  
 Záves 270°, naložené dvířka  
 Kivetőpánt 270°, rázáródó  
 Balama 270°, aplicata

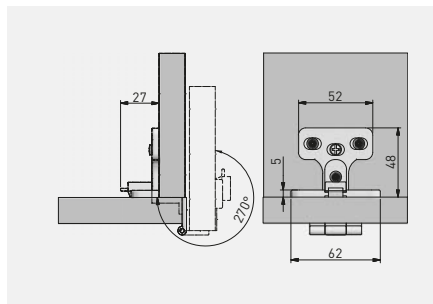

ZP-KT0270-BE	—	—	nikel nikel nikel	ZnAl



Cylindrický záves  
 Cylindrický záves  
 Békapánt nagy  
 Balama aruncatoare mare

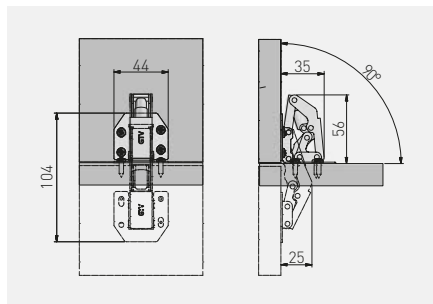





ZT-HF-01-D00	—	—	nikel nikel nikel	ocel ocel ocel

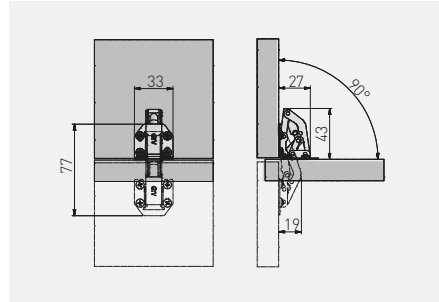

Cylindrický závěs malý  
 Cylindrický záves malý  
 Békapánt kicsi  
 Balama aruncatoare mică







				
ZT-HF-01-M00	—	—	nikel nikel nikkel nichel	ocel ocel acél oțel

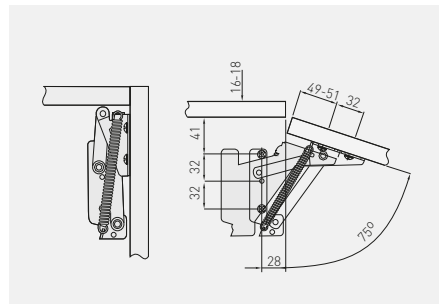

Závěs JUNIOR 75°  
 Zăves JUNIOR 75°  
 Felnyílló zsanér JUNIOR 75°  
 Balama JUNIOR 75°



				
ZP-JUNIOR-00	—	—	nikel nikel nikkel nichel	ocel ocel acél oțel



Křídlový záves pro skládací dveře šedý  
 Křídlový záves pre skládacie dvere šedý  
 Pillangó zsanér  
 Balama aripi

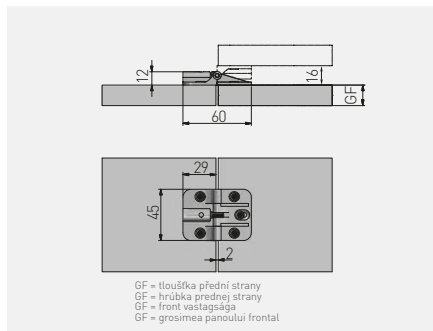

ZP-SKR-00-80	—	—	lak lak lak lac	šedá sivá szürke gri	ZnAl



Válečkový záves  
 Cylindrický záves  
 Befurós, rejtett zsanér  
 Balama cilindrică

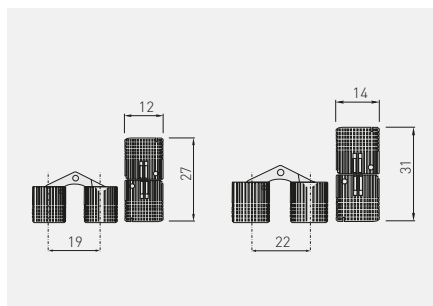

ZC-GTV-12-00	1 sada = 2 ks 1 súprava = 2 ks 1 készlet = 2 db 1 set = 2 buc	12	7	mosaz, mosadz, sárgaréz, alamă	mosaz, mosadz, sárgaréz, alamă
ZC-GTV-14-00		14			



Barový závěs  
Barový záves  
Pánt VIM olajtelszkóphoz  
Balama pt piston VIM cu ulei

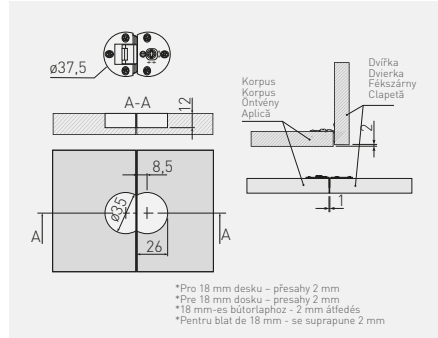

PD-MD-ZB-01-KPL	1 sada = 2 ks 1 súprava = 2 ks 1 készlet = 2 db 1 set = 2 buc	chrom / chróm / króm / crom	ZnAl
PD-MD-ZB-04-KPL		starožitná mosaz / starožitná mosadz / antik bronz / alama antică	



Vrtací šablona pro závěsy  
Vrtacia šablóna pre závěsy  
Fúrósablon kivetőpántokhoz  
Șablon de găurit pentru balamale

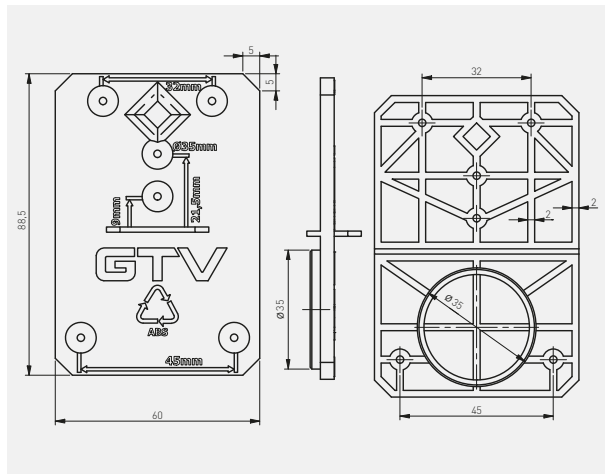

ZM-SZABLON-ZAW	plast / plast / műanyag / plastic

TIP-ON s křížovým adaptérem  
 TIP-ON s křížovým adaptérom  
 Ajtófék, kereszt adapterrel  
 Amortizor cu adaptor încrucișat

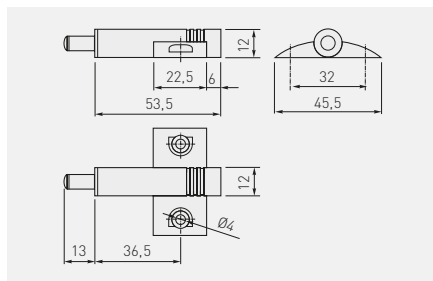

AM-KRZYZ-KPL

šedá  
 sivá  
 szürke  
 gri

plast  
 plast  
 műanyag  
 plastic



TIP-ON AM-0DB zápusťný  
 TIP-ON AM-0DB zápusťný  
 Ajtófék AM-0DB  
 Amortizor AM-0DB

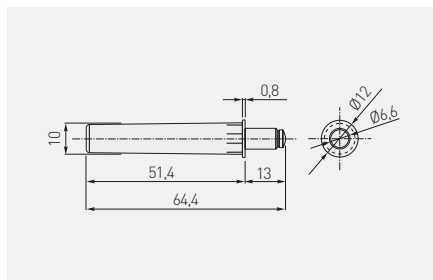

AM-0DB000-60

standard

šedá / sivá / szürke / gri

bílá / biela / fehér / alb

plast / plast / műanyag / plastic



Adaptér AM-ODB přímý  
 Adaptér AM-ODB, priamy  
 AM-ODB adapter egyenes  
 Adaptor AM-ODB drept

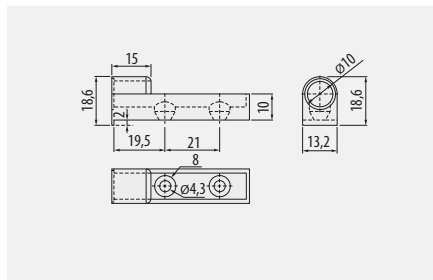

AM-ADAP0B-60	šedá / sivá / szürke / gri	plast / plast / műanyag / plastic
AM-ADAP0B-10	bílá / biela / fehér / alb	



Křížový adaptér AM-ODB  
 Křížový adaptér AM-ODB  
 Keresztadapter AM-ODB  
 Adaptor încrucișat AM-ODB

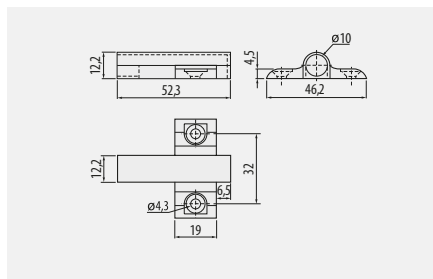

AM-ADAP0A-60	šedá / sivá / szürke / gri	plast / plast / műanyag / plastic
AM-ADAP0A-10	bílá / biela / fehér / alb	



TIP-ON SALTO zápustný - krátky  
 TIP-ON SALTO zapustený, krátky  
 Ajtófék SALTO, súllyesztett, rövid  
 Amortizor SALTO încastrat, scurt

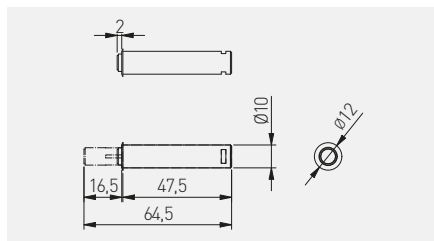

AM-0WM-KR-MG-10	magnetická koncovka / magnetická koncovka / mágneses véggel / vârf magnetic	bílá / biela / fehér / alb	min. 3,5	plast plast műanyag plastic
AM-0WM-KR-GM-10	gumová koncovka / gumová koncovka / gumi véggel / cu vârf de cauciuc			
AM-0WM-KR-MG-30	magnetická koncovka / magnetická koncovka / mágneses véggel / vârf magnetic	šedá / sivá / szürke / gri		
AM-0WM-KR-GM-30	gumová koncovka / gumová koncovka / gumi véggel / cu vârf de cauciuc			
AM-0WM-KR-MG-60	magnetická koncovka / magnetická koncovka / mágneses véggel / vârf magnetic	antracitová / antracitová / antracit / antracit		
AM-0WM-KR-GM-60	gumová koncovka / gumová koncovka / gumi véggel / cu vârf de cauciuc			



TIP-ON SALTO zápustný dlouhý  
 TIP-ON SALTO zapustený, dlhý  
 Ajtófék SALTO, súllyesztett, hosszú  
 Amortizor SALTO, încastrată, lungă

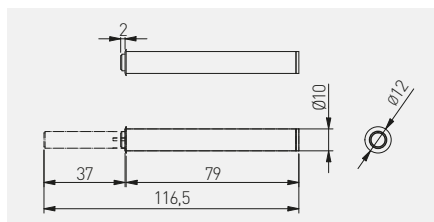





AM-0WM-DL-MG-10	magnetická koncovka / magnetická koncovka / mágneses véggel / vârf magnetic	bílá / biela / fehér / alb	min. 3,5	plast plast műanyag plastic
AM-0WM-DL-GM-10	gumová koncovka / gumová koncovka / gumi véggel / cu vârf de cauciuc			
AM-0WM-DL-MG-30	magnetická koncovka / magnetická koncovka / mágneses véggel / vârf magnetic	šedá / sivá / szürke / gri		
AM-0WM-DL-GM-30	gumová koncovka / gumová koncovka / gumi véggel / cu vârf de cauciuc			
AM-0WM-DL-MG-60	magnetická koncovka / magnetická koncovka / mágneses véggel / vârf magnetic	antracitová / antracitová / antracit / antracit		
AM-0WM-DL-GM-60	gumová koncovka / gumová koncovka / gumi véggel / cu vârf de cauciuc			



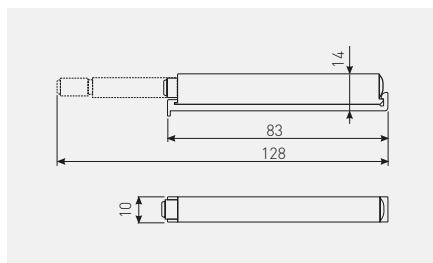

TIP-ON s přímým adaptérem AM-PL  
 TIP-ON s priamym adaptérom AM-PL  
 Ajtófék AM-PL adapterrel  
 Amortizor cu adaptor AM-PL







				
AM-PL-DL-MAG	magnetická koncovka / magnetická koncovka / mágneses véggel / váf magnetic	šedá sivá szürke gri	min. 2,5	plast plast műanyag plastic
AM-PLA-DLU-0	gumová koncovka / gumová koncovka / gumi véggel / cu váf de cauciuc		min. 4,5	

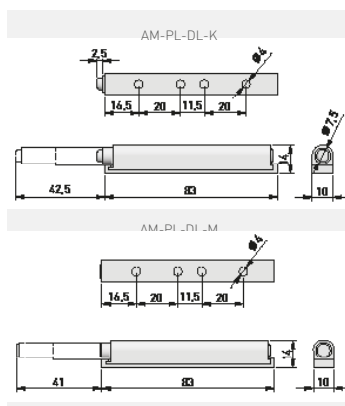

TIP-ON s přímým adaptérem AM-PL  
 TIP-ON s priamym adaptérom AM-PL  
 Ajtófék AM-PL adapterrel  
 Amortizor cu adaptor AM-PL



				
AM-PL-DL-M	magnetická koncovka / magnetická koncovka / mágneses véggel / váf magnetic	šedá sivá szürke gri	min. 2,5	plast plast műanyag plastic
AM-PL-DL-K	gumová koncovka / gumová koncovka / gumi véggel / cu váf de cauciuc		min. 3,5	



TIP-ON SALTO krátky s adaptérem  
 TIP-ON SALTO krátky s adaptérom  
 Ajtófék SALTO, rövid, adapterrel  
 Amortizor SALTO, scurtă, cu adaptor

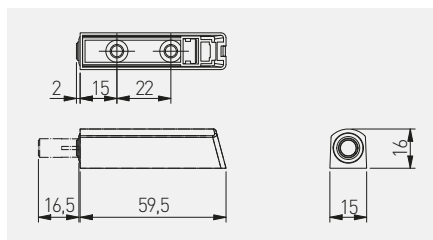

AM-0AM-KR-MG-10	magnetická koncovka / magnetická koncovka / mágneses véggel / vârf magnetic	bílám / biela / fehér / alb	min. 2,5	plast / plast / műanyag / plastic
AM-0AM-KR-GM-10	gumová koncovka / gumová koncovka / gumi véggel / cu vârf de cauciuc			
AM-0AM-KR-MG-30	magnetická koncovka / magnetická koncovka / mágneses véggel / vârf magnetic	šedá / sivá / szürke / gri	min. 2,5	plast / plast / műanyag / plastic
AM-0AM-KR-GM-30	gumová koncovka / gumová koncovka / gumi véggel / cu vârf de cauciuc			
AM-0AM-KR-MG-60	magnetická koncovka / magnetická koncovka / mágneses véggel / vârf magnetic	antracitová / antracitová / antracit / antracit	min. 2,5	plast / plast / műanyag / plastic
AM-0AM-KR-GM-60	gumová koncovka / gumová koncovka / gumi véggel / cu vârf de cauciuc			



TIP-ON SALTO dlouhý s adaptérem  
 TIP-ON SALTO dlhý s adaptérom  
 Ajtófék SALTO, hosszú, adapterrel  
 Amortizor SALTO, lungă, cu adaptor

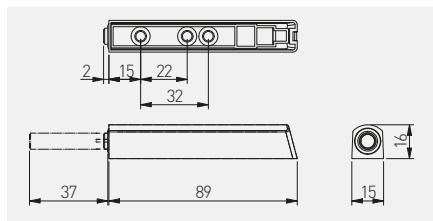

AM-0AM-DL-MG-10	magnetická koncovka / magnetická koncovka / mágneses véggel / vârf magnetic	bílá / biela / fehér / alb	min. 3,5	plast / plast / műanyag / plastic
AM-0AM-DL-GM-10	gumová koncovka / gumová koncovka / gumi véggel / cu vârf de cauciuc			
AM-0AM-DL-MG-30	magnetická koncovka / magnetická koncovka / mágneses véggel / vârf magnetic	šedá / sivá / szürke / gri	min. 3,5	plast / plast / műanyag / plastic
AM-0AM-DL-GM-30	gumová koncovka / gumová koncovka / gumi véggel / cu vârf de cauciuc			
AM-0AM-DL-MG-60	magnetická koncovka / magnetická koncovka / mágneses véggel / vârf magnetic	antracitová / antracitová / antracit / antracit	min. 3,5	plast / plast / műanyag / plastic
AM-0AM-DL-GM-60	gumová koncovka / gumová koncovka / gumi véggel / cu vârf de cauciuc			



Otvárací mechanizmus AM-ZAT  
 Otvárací mechanizmus AM-ZAT  
 Ajtókilökö AM-ZAT  
 Amortizor push 2 open AM-ZAT

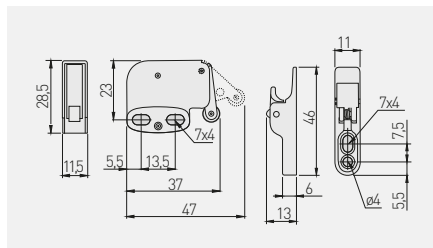

		
AM-ZAT-A1-10	biélam biela fehér atb	ocel + plast, ocel + plast, acél + műanyag, ořet + plastic



Určeno pro samozavírací záves  
 GTV ZP-POH045ZE0

Určené pre samozatvárací záves  
 GTV ZP-POH045ZE0

A GTV önnnyíló ZP-POH045ZE0 pánthoz  
 Dedicat pentru balama cu deschidere  
 automată GTV ZP-POH045ZE0

Szilikonová dorazová čočka  
 Silikónový tlmíč  
 Szilikon csillapító pontok  
 Bumponi din silicon



		
AMR-BP-1003	Ø10 x 3	100 ks / blister, 100 ks / blister, 100 db / iv, 100 buc / tablă
AMR-BP-0715	Ø7 x 1,5	



Vzpěra PD-LIFTNEW  
 Výklop PD-LIFTNEW  
 Teleskóp PD-LIFTNEW  
 Piston PD-LIFTNEW

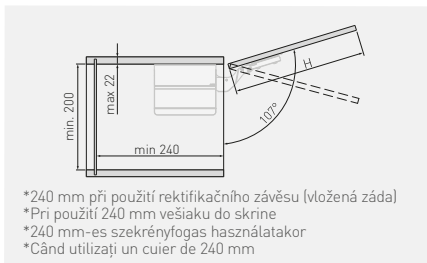

	Přibližná výška dvířek Približná výška dvierok Hozzávetőleges magasság Inăltătime front aproximativ	Faktor F Faktor F F teljesítménytényező Factorul de putere F	Síla pružiny Sila pružiny Rugđeró Putere arc		
PD-LIFTNEW-LIGHT-10	250 – 400 mm	480 – 1250	light		ocel ocel acél oțel
PD-LIFTNEW-LIGHT-80					
PD-LIFTNEW-MEDIUM-10	250 – 500 mm	960 – 2350	medium		ocel ocel acél oțel
PD-LIFTNEW-MEDIUM-80					
PD-LIFTNEW-STRONG-10	250 – 500 mm	1600 – 3600	strong		ocel ocel acél oțel
PD-LIFTNEW-STRONG-80					
PD-LIFTNEW-STRONG-PLUS-10	600 mm	2500 – 4500	extra strong		ocel ocel acél oțel
PD-LIFTNEW-STRONG-PLUS-80					

Faktor F = výška dvířek x hmotnost dvířek včetně dvojnásobku váhy úchytky (kg)  
 Faktor F = výška dvierok x hmotnosť dvierok vrátane dvojnásobku váhy úchytky (kg)  
 F teljesítménytényező = panel magasság x panel kétszeres fogantyú súlyal (kg)  
 Factor de putere F = înăltătime front x greutatea front cu greutatea dublă a mânerului (kg)

Vzpěra PD-LIFT-P20  
 Výklop PD-LIFT-P20  
 Teleskóp push 2 open PD-LIFT-P20  
 Piston cu push 2 open PD-LIFT-P20

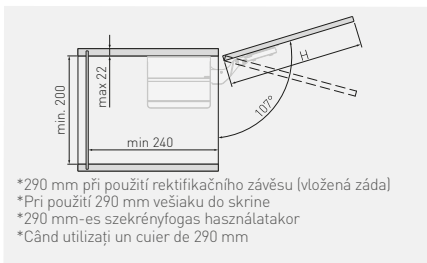

	Přibližná výška dvířek Približná výška dvierok Hozzávetőleges magasság Inăltătime front aproximativ	Faktor F Faktor F F teljesítménytényező Factorul de putere F	Síla pružiny Sila pružiny Rugđeró Putere arc		
PD-LIFT-P20-LIGHT-10	250 – 400 mm	580 – 1350	light		ocel ocel acél oțel
PD-LIFT-P20-LIGHT-80					
PD-LIFT-P20-MEDIUM-10	250 – 500 mm	1060 – 2450	medium		ocel ocel acél oțel
PD-LIFT-P20-MEDIUM-80					
PD-LIFT-P20-STRONG-10	250 – 500 mm	1800 – 4000	strong		ocel ocel acél oțel
PD-LIFT-P20-STRONG-80					
PD-LIFT-P20-STRONG-PLUS-10	600 mm	2600 – 5000	extra strong		ocel ocel acél oțel
PD-LIFT-P20-STRONG-PLUS-80					

Faktor F = výška dvířek x hmotnost dvířek včetně dvojnásobku váhy úchytky (kg)  
 Faktor F = výška dvierok x hmotnosť dvierok vrátane dvojnásobku váhy úchytky (kg)  
 F teljesítménytényező = panel magasság x panel kétszeres fogantyú súlyal (kg)  
 Factor de putere F = înăltătime front x greutatea front cu greutatea dublă a mânerului (kg)

Vzpěra PD-MINILIFTNEW  
 Výklop PD-MINILIFTNEW  
 Teleskóp PD-MINILIFTNEW  
 Piston PD-MINILIFTNEW

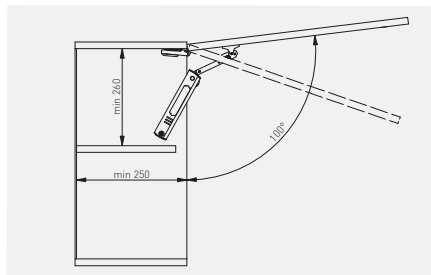

	Rozměry dvířek Rozmery čela Elülcső méretek Dimenziuni frontale		Váha dvířek Hmotnosť čela Front súly Greutate fațã	Doporučené množství zvedáků (ks) Odporúčaný počet zdvíhačkov (ks) Az emelők ajánlott száma (db) Numărul recomandat de brațe telescopice (buc.)		
	výška magasság înălțime	šířka šírka szélesség lățime				
PD-MINILIFTNEW-LIGHT	300-400 mm	500-800 mm	2-3 kg	1	chrom / chróm / króm / crom	ocel acél oțel
PD-MINILIFTNEW-LIGHT-20	300-400 mm	500-1000 mm	3,1-4 kg	2	černá / čierna / fekete / negru	
PD-MINILIFTNEW-MEDIUM	300-450 mm	500-1000 mm	3,5-4,5 kg	1	chrom / chróm / króm / crom	
PD-MINILIFTNEW-MEDIUM-20	300-450 mm	500-1200 mm	5,5-7,5 kg	2	černá / čierna / fekete / negru	
PD-MINILIFTNEW-STRONG	380-550 mm	500-1200 mm	5-6 kg	1	chrom / chróm / króm / crom	
PD-MINILIFTNEW-STRONG-20	380-550 mm	500-1200 mm	6,5-10 kg	2	černá / čierna / fekete / negru	



Plynová výklopná vzpěra s tlumičem, nastavitelná  
 Plynová výklopná vzpera s tlmíčom, nastaviteľná  
 Gázteleszkóp fékkel, állítható  
 Piston cu gaz cu tampon, reglabil

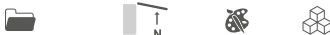
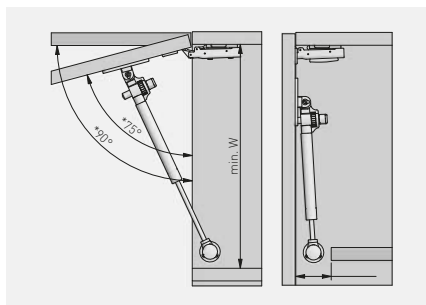

PD-GAM050-N02	50 N	šedá sivá szürke gri	ocel ocel acél oțel
PD-GAM060-N02	60 N		
PD-GAM080-N02	80 N		
PD-GAM100-N02	100 N		
PD-GAM120-N02	120 N		
PD-GAM150-N02	150 N		
PD-GAM050-N10	50 N	bílám biela fehér alb	
PD-GAM060-N10	60 N		
PD-GAM080-N10	80 N		
PD-GAM100-N10	100 N		
PD-GAM120-N10	120 N		
PD-GAM150-N10	150 N		
PD-GAM050-N60	50 N	antracitová antracitová antracit antracit	
PD-GAM060-N60	60 N		
PD-GAM080-N60	80 N		
PD-GAM100-N60	100 N		
PD-GAM120-N60	120 N		
PD-GAM150-N60	150 N		

Úhel otevření dvířek, Uhol otvárania dveríok, Az ajtó nyitási szöge, Unghiul de deschidere a ușii	H (mm)	L (mm)	W (mm)
75°	295	64	315
90°	275	52	300



Úhel otevření dvířek, Uhol otvárania dveríok, Az ajtó nyitási szöge, Unghiul de deschidere a ușii	Síla vzpěry, Síla výklopu, Emelőerő, Forța de ridicare	Výška dvířek (mm) / Výška dveríok (mm) / Ajtó magassága (mm) / Înălțimea ușii (mm)			
		300	400	500	600
		Hmotnost dvířek (kg) / Hmotnosť dveríok (kg) / Ajtó súlya (kg) / Greutatea ușii (kg)			
75°	50 N	1,6	1,2	1,0	0,8
	60 N	2,0	1,5	1,2	1,0
	80 N	2,7	2,0	1,6	1,4
	100 N	3,4	2,6	2,0	1,7
	120 N	4,1	3,1	2,5	2,0
	150 N	4,7	3,5	2,9	2,4
90°	50 N	1,5	1,1	0,9	0,7
	60 N	1,8	1,3	1,1	0,9
	80 N	2,4	1,8	1,4	1,2
	100 N	3,0	2,2	1,8	1,5
	120 N	3,6	2,7	2,1	1,8
	150 N	4,1	3,2	2,3	2,1



Plynová výklopná vzpěra standart  
 Plynová výklopná vzpera štandard  
 Gázteleszkóp sztandard  
 Piston cu gaz standard

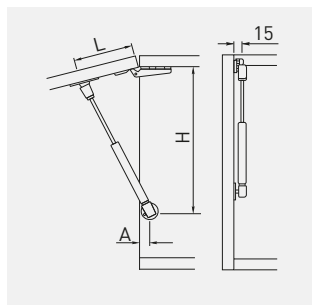

PD-G0050-N02	50 N	šedá sivá szürke gri	ocel ocel acél oţel
PD-G0060-N02	60 N		
PD-G0080-N02	80 N		
PD-G0100-N02	100 N		
PD-G0120-N02	120 N		
PD-G0150-N02	150 N		



Úhel otváření dvířek, Uhol otvárania dverok, Az ajtó nyitási szöge, Unghiul de deschidere a uşii	Vložená dvířka, Vložené dverka, Behajtó ajtó, Uşă introdusă			Polonaložená dvířka, polonaložené dverka, Ikerajtó, Uşă dublă			Naložená dvířka, Naložené dverka, félíg rázáródó ajtó, Uşă acoperită		
	H (mm)	L (mm)	A (mm)	H (mm)	L (mm)	A (mm)	H (mm)	L (mm)	A (mm)
75°	280	100	20 + tloušťka přední strany, 20 + hrúbka prednej strany, 20 + panel vastagság, 20 + grosimi front	272	100	25	264	100	25
90°	260	90		251	90	25	244	90	25
100°	250	80		242	80	25	234	80	25

Úhel otváření dvířek, Uhol otvárania dverok, Az ajtó nyitási szöge, Unghiul de deschidere a uşii	Síla vzpěry, Síla výklopu, Emelőerő, Forţa de ridicare	Výška dvířek (mm) / Výška dverok (mm) / Ajtó magassága (mm) / Înălţimea uşii (mm)			
		300	400	500	600
		Hmotnost dvířek (kg) / Hmotnosť dverok (kg) / Ajtó súlya (kg) / Greutatea uşii (kg)			
 75°	60 N	2,0	1,5	1,2	1,0
	80 N	2,7	2,0	1,6	1,4
	100 N	3,4	2,6	2,0	1,7
	120 N	4,1	3,1	2,5	2,0
	150 N	4,7	3,5	2,9	2,4
 90°	60 N	1,8	1,3	1,1	0,9
	80 N	2,4	1,8	1,4	1,2
	100 N	3,0	2,2	1,8	1,5
	120 N	3,6	2,7	2,1	1,8
	150 N	4,1	3,2	2,3	2,1
 100°	60 N	1,6	1,2	0,9	0,8
	80 N	2,1	1,6	1,2	1,0
	100 N	2,6	1,9	1,6	1,3
	120 N	3,1	2,3	1,9	1,6
	150 N	3,5	2,6	2,2	1,9



Plynová výklopná vzpěra standart  
 Plynová výklopná vzpera štandard  
 Gázteleszkóp sztandard  
 Piston cu gaz standard



PD-G0050-N03	50 N	šedá sivá szürke gri	ocel ocel acél ojet
PD-G0060-N03	60 N		
PD-G0080-N03	80 N		
PD-G0100-N03	100 N		
PD-G0120-N03	120 N		
PD-G0150-N03	150 N		

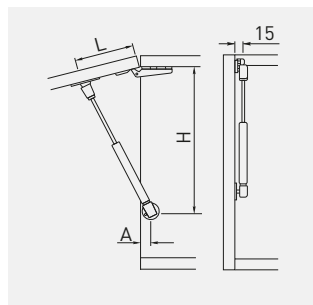

Úhel otvorení dvířek, Uhol otvárania dverok, Az ajtó nyitási szöge, Unghiul de deschidere a ușii	Naložená dvířka, Naložené dverka, fétig rázáródó ajtó, Ușă acoperită		
	H (mm)	L (mm)	A (mm)
75°	280	72	12
90°	237	60	
100°	228	52	

Úhel otvorení dvířek, Uhol otvárania dverok, Az ajtó nyitási szöge, Unghiul de deschidere a ușii	Síla vzpěry, Síla výklopu, Emelőerő, Forța de ridicare	Výška dvířek (mm) / Výška dverok (mm) / Ajtó magassága (mm) / Înălțimea ușii (mm)			
		300	400	500	600
		Hmotnost dvířek (kg) / Hmotnosť dverok (kg) / Ajtó súlya (kg) / Greutatea ușii (kg)			
75°	50 N	1,6	1,2	1,0	0,8
	60 N	2,0	1,5	1,2	1,0
	80 N	2,7	2,0	1,6	1,4
	100 N	3,4	2,6	2,0	1,7
	120 N	4,1	3,1	2,5	2,0
90°	50 N	1,5	1,1	0,9	0,7
	60 N	1,8	1,3	1,1	0,9
	80 N	2,4	1,8	1,4	1,2
	100 N	3,0	2,2	1,8	1,5
	120 N	3,6	2,7	2,1	1,8
100°	50 N	1,1	1,0	0,8	0,7
	60 N	1,6	1,2	0,9	0,8
	80 N	2,1	1,6	1,2	1,0
	100 N	2,6	1,9	1,6	1,3
	120 N	3,1	2,3	1,9	1,6
150 N	3,5	2,6	2,2	1,9	

Plynová výklopná vzpěra, krátká  
 Plynová výklopná vzpera, krátká  
 Gázteleszkóp rövid  
 Piston cu gaz scurt

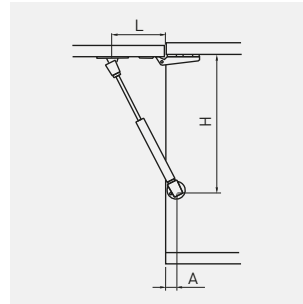

PD-G60160-02	60 N	šedá sivá szürke gri	ocel ocel acél oţel
PD-G80160-02	80 N		



Úhel otvřování dvířek, Uhol otvárania dverok, Az ajtó nyitási szöge, Unghiul de deschidere a uşii	Vložená dvířka, Vložené dverka, Behajló ajtó, Uşă introdusă			Polonaložená dvířka, polonaložené dverka, Ikerajtó, Uşă dublă			Naložená dvířka, Naložené dverka, fellig rázáródó ajtó, Uşă acoperită		
	H (mm)	L (mm)	A (mm)	H (mm)	L (mm)	A (mm)	H (mm)	L (mm)	A (mm)
75°	188	70	20 + tloušťka přední strany, 20 + hrúbka prednej strany, 20 + panel vastagság, 20 + grosimi front	180	70	20	172	70	20
90°	176	60		167	60	20	160	60	20
100°	172	50		164	50	20	154	50	20

Úhel otvřování dvířek, Uhol otvárania dverok, Az ajtó nyitási szöge, Unghiul de deschidere a uşii	Síla vzpěry, Síla výklopu, Emelőerő, Forţa de ridicare	Výška dvířek (mm) / Výška dverok (mm) / Ajtó magassága (mm) / Înălţimea uşii (mm)			
		300	400	500	600
		Hmotnost dvířek (kg) / Hmotnosť dverok (kg) / Ajtó súlya (kg) / Greutatea uşii (kg)			
 75°	60 N	2,0	1,5	1,2	1,0
	80 N	2,7	2,0	1,6	1,4
 90°	60 N	1,8	1,3	1,1	0,9
	80 N	2,4	1,8	1,4	1,2
 100°	60 N	1,6	1,2	0,9	0,8
	80 N	2,1	1,6	1,2	1,0

Zvedák DESIGN mechanický  
 Zdvihák DESIGN mechanický  
 Mechanikus felnyitó lift DESIGN  
 Piston mecanic DESIGN



PD-GPD01-001	chrom / chróm / króm / crom	ocel ocel acél ojel
PD-GPD02-002	satén / satén / szatén / satin	
PD-GPD03-005	hliník / hliník / alumínium / aluminiu	

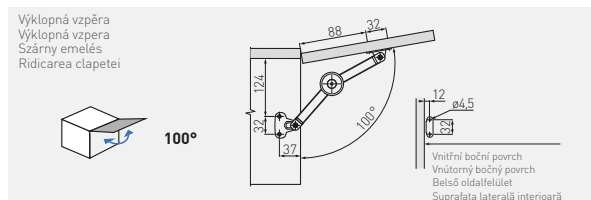

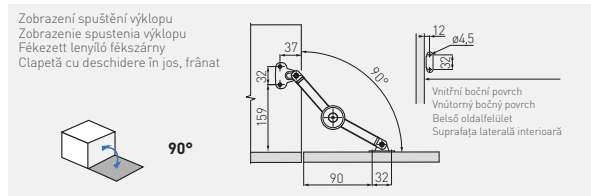
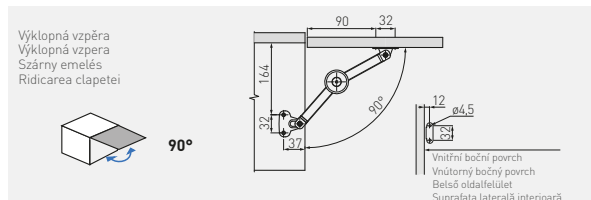
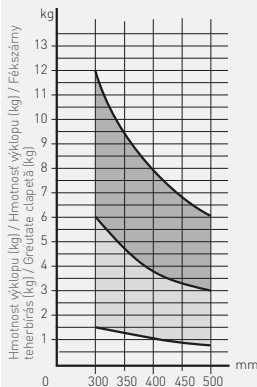
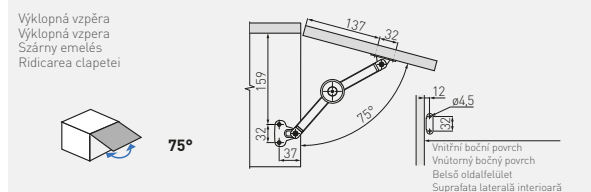
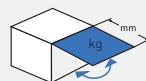

Maximální hmotnost v závislosti na výšce vyklápění.  
 Maximálna hmotnosť v závislosti na výške vyklápania.  
 Maximális súly a szárny magasságától függően.  
 Greutate maximă în funcție de înălțimea clapetei.



- 1 výklopná vzpěra  
1 výklopná vzpera  
1 teleszkóp  
1 piston
- 2 výklopné vzpěry  
2 výklopné vzpery  
2 teleszkópy  
2 pistoane

Mechanický zvedák standard  
 Mechanický zdvihák štandard  
 Mechanikus felnyíló lift sztandard  
 Piston mecanic standard



		
PD-PD000-001	chrom / chróm / króm / crom	ocel / ocel / acél / otel



Výklopná vzpěra  
 Výklopná vzpera  
 Szárny emelés  
 Ridicarea clapetei

**100°**

Vnitřní boční povrch  
 Vnútročný bočný povrch  
 Belső oldalfelület  
 Suprafața laterală interioară

Výklopná vzpěra  
 Výklopná vzpera  
 Szárny emelés  
 Ridicarea clapetei

**75°**

Vnitřní boční povrch  
 Vnútročný bočný povrch  
 Belső oldalfelület  
 Suprafața laterală interioară

Výklopná vzpěra  
 Výklopná vzpera  
 Szárny emelés  
 Ridicarea clapetei

**90°**

Vnitřní boční povrch  
 Vnútročný bočný povrch  
 Belső oldalfelület  
 Suprafața laterală interioară



Zobrazení spuštění výklopu  
 Zobrazenie spustenia výklopu  
 Fékezett lenyíló fékszárny  
 Clapetă cu deschidere în jos, frânat

**90°**

Vnitřní boční povrch  
 Vnútročný bočný povrch  
 Belső oldalfelület  
 Suprafața laterală interioară

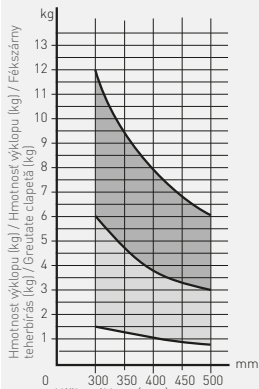
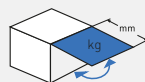

Maximální hmotnost v závislosti na výšce vyklápění.  
 Maximálna hmotnosť v závislosti na výške vyklápania.  
 Maximális súly a szárny magasságától függően.  
 Greutate maximă în funcție de înălțimea clapetei.



-  1 výklopná vzpěra  
 1 výklopná vzpera  
 1 teleszkóp  
 1 piston
-  2 výklopné vzpěry  
 2 výklopné vzpery  
 2 teleszkóp  
 2 pistoane

Mechanický zvedák standard  
 Mechanický zdvihák štandard  
 Mechanikus felnyíló lift sztandard  
 Piston mecanic standard



		
PD-PD000-001B	chrom / chróm / króm / crom	ocel / ocel / acél / otel



Výklopná vzpěra  
 Výklopná vzpera  
 Szárny emelés  
 Ridicarea clapetei

100°

Vnitřní boční povrch  
 Vnútrotný bočný povrch  
 Belső oldalfelület  
 Suprafața laterală interioară

Výklopná vzpěra  
 Výklopná vzpera  
 Szárny emelés  
 Ridicarea clapetei

75°

Vnitřní boční povrch  
 Vnútrotný bočný povrch  
 Belső oldalfelület  
 Suprafața laterală interioară

Výklopná vzpěra  
 Výklopná vzpera  
 Szárny emelés  
 Ridicarea clapetei

90°

Vnitřní boční povrch  
 Vnútrotný bočný povrch  
 Belső oldalfelület  
 Suprafața laterală interioară



Zobrazení spuštění výklopu  
 Zobrazenie spustenia výklopu  
 Fékezett lenyíló fékszárny  
 Clapetă cu deschideră în jos, frânat

90°

Vnitřní boční povrch  
 Vnútrotný bočný povrch  
 Belső oldalfelület  
 Suprafața laterală interioară

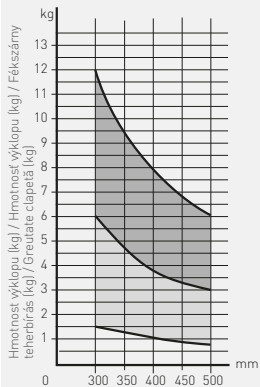
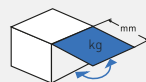
Maximální hmotnost v závislosti na výšce vyklápění.  
 Maximálna hmotnosť v závislosti na výške vyklápania.  
 Maximális súly a szárny magasságától függően.  
 Greutate maximă în funcție de înălțimea clapetei.



-  1 výklopná vzpěra  
1 výklopná vzpera  
1 teleszkóp  
1 piston
-  2 výklopné vzpery  
2 výklopné vzpery  
2 teleszkópy  
2 pistoane

Plynová výklopná vzpěra VIM pro vyklápěcí dvířka skříňky, krátká  
 Plynová výklopná vzpera VIM pre vyklápacie dverka skrinky, krátká  
 Rövid Olajos teleszkóp VIM  
 Piston cu ulei VIM, cu brat scurt



Kompatibilní s výklopným závěsem: PD-MD-ZB  
 Kompatibilný s výklopným závesom: PD-MD-ZB  
 Kompatibilis a fedélpánttal: PD-MD-ZB  
 Compatibil cu balama cu clapă: PD-MD-ZB

PD-MDLIFT-P1-D	šedá / sivá / szürke / gri	ocel ocel acél ojet



Maximální hmotnost v závislosti na výšce vyklápění.  
 Maximálna hmotnosť v závislosti na výške vyklápania.  
 Maximális súly a fékszárny magasságától függően.  
 Greutate maximă în funcție de înălțimea clapetei.

výška výška magasság іншітє	šířka / šířka / szélesség / лїтє			
	600 mm	700 mm	800 mm	900 mm
	Počet vzpěr / Počet vzper / Teleszkópok száma / Numărul de pistoane			
250 mm	1	1	2	2
260 mm				
270 mm				
280 mm				
290 mm				
300 mm	2	2	2	
310 mm				
320 mm				
330 mm				
340 mm				

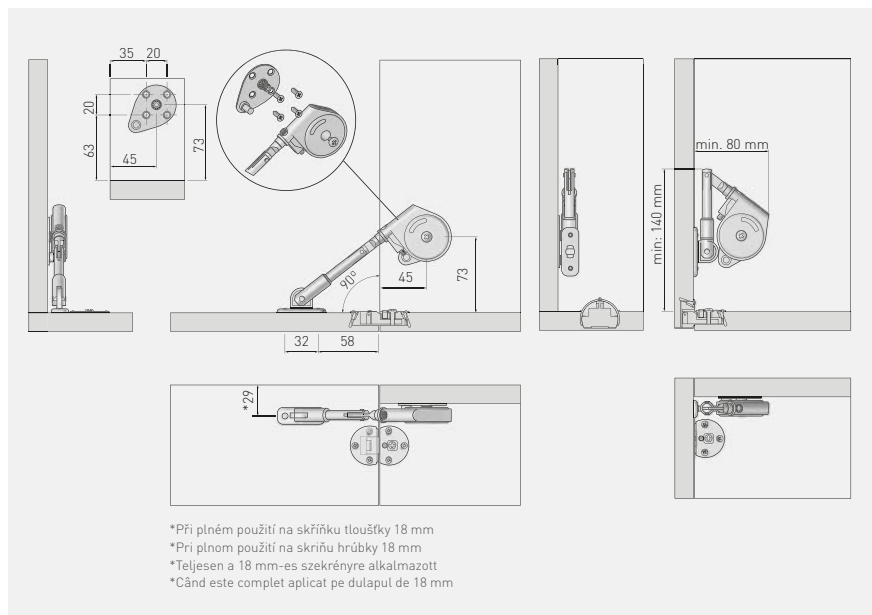

Plynová výklopná vzpěra VIM pro vyklápěcí dvířka skřínky, dlouhá  
 Plynová výklopná vzpera VIM pre vyklápacie dvierka skrinky, dlhá  
 Hosszú Olajos teleszkóp VIM  
 Piston cu ulei VIM, cu brat lung



Kompatibilní s výklopným závěsem: PD-MD-ZB  
 Kompatibilný s výklopným závesom: PD-MD-ZB  
 Kompatibilis a fedélpánttal: PD-MD-ZB  
 Compatibil cu balama cu clapă: PD-MD-ZB

Maximální hmotnost v závislosti na výšce vyklápění.  
 Maximálna hmotnosť v závislosti na výške vyklápania.  
 Maximális súly a fékszárny magasságától függően.  
 Greutate maximă în funcție de înălțimea clapetei.

		
PD-MDLIFT-P2-D	šedá / sivá / szürke / gri	ocel ocel acél oțel





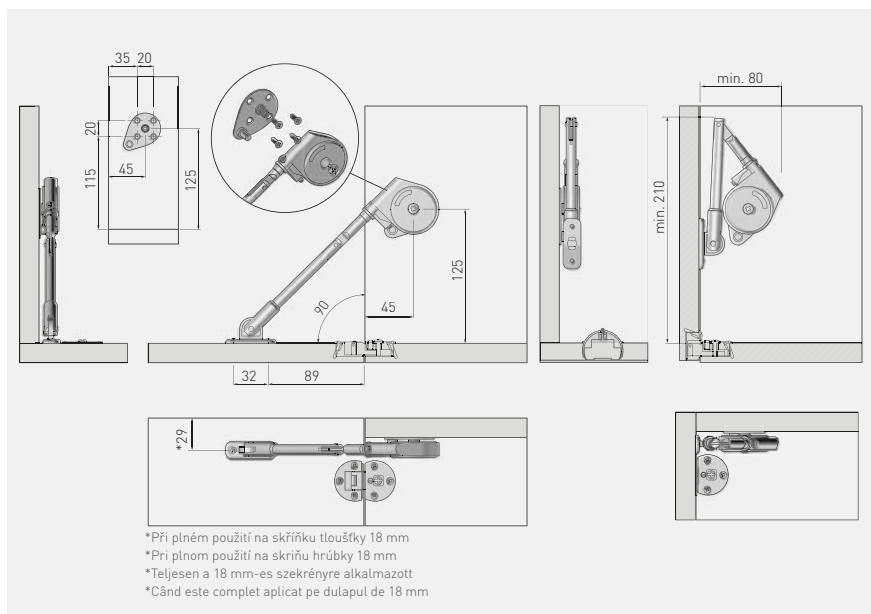

výška výška magasság înălțime	šířka / šířka / szélesség / lățime			
	600 mm	700 mm	800 mm	900 mm
	Počet vzpěr / Počet vzpier / Teleszkópok száma / Numărul de pistoane			
350 mm	1	2	2	2
360 mm				
370 mm				
380 mm				
390 mm				
400 mm				

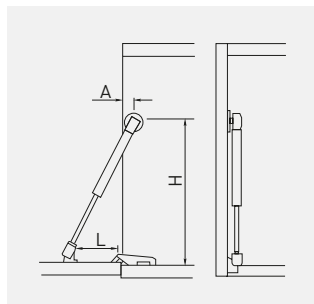

Olejevý tlumič k předním dveřím barové skřínky  
 Olejový tlmíč k predným dverám barovej skrínky  
 Lenyillo olajos teleszkop legördülő szekrényajtókhöz  
 Piston cu ulei pentru uși de dulap, deschidere in jos



				
PD-ECGDL-060		60 N	šedá sivá szürke gri	ocel ocel acél oțel
PD-ECGDL-080		80 N		
PD-ECGDL-150		150 N		

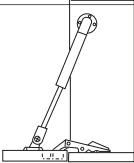

Úhel otváraní dvířek, Uhol otvárania dverok, Az ajtó nyitási szöge, Unghiul de deschidere a ușii	Vložená dvířka, Vložené dverka, Behajló ajtó, Ușă introdusă			Polonaložená dvířka, Polonaložené dverka, Ikerajtó, Ușă dublă			Naložená dvířka, Naložené dverka, fétig rázáródó ajtó, Ușă acoperită		
	H (mm)	L (mm)	A (mm)	H (mm)	L (mm)	A (mm)	H (mm)	L (mm)	A (mm)
90°	260	90	45	253	90	25	246	90	25

Úhel otváraní dvířek, Uhol otvárania dverok, Az ajtó nyitási szöge, Unghiul de deschidere a ușii	Síla vzpěry Síla výklopu, Emelőerő, Forța de ridicare	Výška dvířek (mm) / Výška dverok (mm) / Ajtó magassága (mm) / Înălțimea ușii (mm)			
		300	400	500	600
		Hmotnost dvířek (kg) / Hmotnosť dverok (kg) / Ajtó súlya (kg) / Greutatea ușii (kg)			
 90°	60 N	1,8	1,3	1,1	0,9
	80 N	2,4	1,8	1,4	1,2
	150 N	4,1	3,2	2,3	2,1



Sklopné nůžky  
Nožnice  
Nyíló vasalat  
Braț telescopic

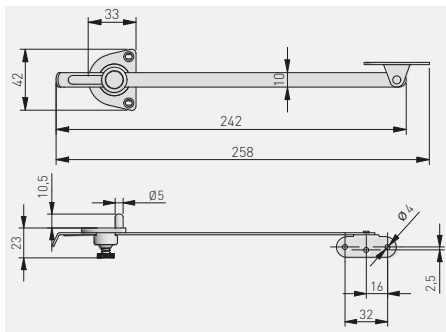

	INFO		
MR-SPG-UNI-GAL*	Univerzální pozinkované samosvorné nůžky Univerzálne galvanizované samosvorné nožnice Univerzális öntáslású nyíló vasalat, horganyzott Braț telescopic cu autocobacare universal galvanizat	šedá sivá szürke gri	ocel + plast, ocel + plast, acél + műanyag, otel + plastic
MR-SPG-UNI-OC	Univerzální pozinkovaný samosvorné nůžky Univerzálne pozinkovaný samosvorné nožnice Univerzális öntáslású nyíló vasalat, horganyzott Braț telescopic cu autocobacare universal galvanizat		



\*K dispozicii pro speciální objednávky / K dispozicii na špeciálne objednávky / Külön megrendelésben kapható / Disponibil pentru comenzi speciale

Výška výklopu (mm) Výška výklopu (mm) Fékszárny magasság (mm) Înălțimea clapetei (mm)	Šírka klapky (mm) Šírka klapky (mm) Szárny szélesség (mm) Lățimea clapetei (mm)							
	300	400	500	600	700	800	900	1000
320	1,1	1,5	1,9	2,1	2,6	2,9	3,3	3,6
350	1,2	1,6	2,0	2,5	2,9	3,3	3,7	4,0
400	1,4	1,8	2,3	2,8	3,3	3,7	4,2	4,6
450	1,6	2,1	2,6	3,1	3,7	4,2	4,7	5,3
500	1,8	2,3	2,9	3,5	4,1	4,7	5,3	5,8
550	1,9	2,6	3,2	3,9	4,5	5,1	5,8	6,4
600	2,1	2,8	3,5	4,2	4,9	5,6	6,3	7,0

Hmotnosť klapky v kg (dřevotřířka: tlouřka 18 mm, hustota=650 kg/m<sup>3</sup>)  
Hmotnosť klapky v kg (drevozriesková doska: hrúbka 18 mm, hustota=650 kg/m<sup>3</sup>)  
A szárny sűlya kg-ban (forgácslap: vastagság 18 mm, sűrűség=650 kg/m<sup>3</sup>)  
Greutatea clapetei în kg (plăci aglomerate: grosime 18 mm, densitate=650 kg/m<sup>3</sup>)

\*pro řirší dvřřka použijte 2 ks nůžek  
\*pre řiršie dvere použijte 2 ks nožnic  
\*szélesebb szárnyakkal - javasolt kettű rögziteni  
\*cu clapte mai late - sunt sugerate 2

Výsuv se spodní montáží Modern Slide Pro  
 Výsuv so spodnou montážou Modern Slide Pro  
 Fiók alatti szerelés Modern Slide Pro  
 Montare sub sertar Modern Slide Pro



okraj skrinky / okraj skrinke / szélek / marginea dulapului

- zásuvkový výsuv L/P  
 zásuvkový výsuv L/P  
 fióksín L/R  
 glisier sertar S/D
- čelní kování včetně šroubů L/P  
 zabezpečovacie zariadenie L/P + skrutky  
 zárszerkezet L/R + csavarok  
 dispozitiv de blocare S/D + suruburi

NL = jmenovitá délka výsuvu  
 nominálna dĺžka výsuvu  
 névleges fióksínhossz  
 lungimea nominală a glisierii

AV = ztráta výsuvu  
 strata výsuvu  
 kihúzás vesztéség  
 pierdereea extensiei

Poznámka pro montáž: pro správnou funkci zásuvky nesmí šířka zásuvky překročit jmenovitou délku výsuvu.  
 Poznámka pre montáž: pre správnu funkciu zásuvky nesmie šírka zásuvky prekročiť nominálnu dĺžku výsuvu.  
 Szerelési információk: a fiók megfelelő működéséhez a fiók szélessége nem haladhatja meg a névleges fióksínhosszat.  
 Informații de montare: pentru o funcționare corectă a sertarului, lățimea sertarului nu poate depăși lungimea nominală a glisierii.

	L mm	AV mm		kg		
PB-3D0SHX18-300-PRO	300	30	plný úplný teljes complet	35		ocel ocel acél oțel
PB-3D0SHX18-350-PRO	350	30				
PB-3D0SHX18-400-PRO	400	30				
PB-3D0SHX18-450-PRO	450	30				
PB-3D0SHX18-500-PRO	500	30				
PB-3D0SHX18-550-PRO	550	30				



Skrýtý výsuv s tlumením OSHX-18 3D  
 Skrytý výsuv s tlmením OSHX-18 3D  
 Rejtett fióksin, csillapított OSHX-18 3D  
 Glisiera sub sertar cu amortizare OSHX-18 3D



okraj skříňky / okraj skrinky / szekrény széle / marginea dulapului

250  
300  
350  
400  
450  
500  
550  
600

32 32 128 96 96

- zásuvkový výsuv L/P  
 zásuvkový výsuv L/P  
 fióksin L/R  
 glisier sertar S/D
- čelní kování včetně šroubů L/P  
 zabezpečovacie zariadenie L/P + skrutky  
 zárszerkezet L/R + csavarok  
 dispozitiv de blocare S/D + suruburi

NL = jmenovitá délka výsuvu  
 nominálna dĺžka výsuvu  
 névleges fióksínhossz  
 lungimea nominală a glisierii

AV = ztráta výsuvu  
 strata výsuvu  
 kihúzás vesztéség  
 pierdere extensiei

Poznámka pro montáž: pro správnou funkci zásuvky nesmí šířka zásuvky překročit jmenovitou délku výsuvu.  
 Poznámka pre montáž: pre správnu funkciu zásuvky nesmie šírka zásuvky prekročiť nominálnu dĺžku výsuvu.  
 Szerelési információk: a fiók szélessége nem haladhatja meg a névleges fióksínhosszat.  
 Informații de montare: pentru o funcționare corectă a sertarului, lățimea sertarului nu poate depăși lungimea nominală a glisierii.

	L mm	AV mm	kg		
PB-3D0SHX18-250-H	250	16	30	pozinkovaný pozinkovaný galvanizált galvanizat	ocel ocel acél oțel
PB-3D0SHX18-300-H	300				
PB-3D0SHX18-350-H	350				
PB-3D0SHX18-400-H	400				
PB-3D0SHX18-450-H	450				
PB-3D0SHX18-500-H	500				
PB-3D0SHX18-550-H	550				
PB-3D0SHX18-600-H	600				

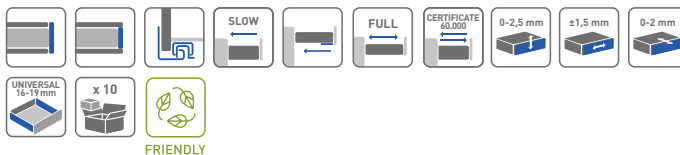

Skrýtý výsuv s tlumením 0SHX-A  
 Skrytý výsuv s tlmením 0SHX-A  
 Rejtett fioksin, csillapított 0SHX-A  
 Glisiera sub sertar cu amortizare 0SHX-A



Montážní rozměry  
 Montážne rozmery  
 Szerelési méretek  
 Dimensiuni de montare

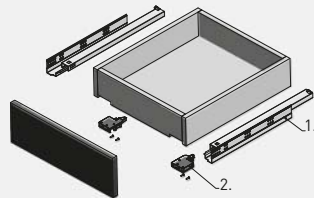
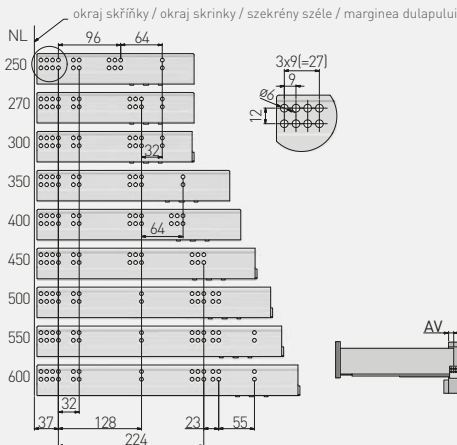

- zásuvkový výsuv L/P  
 zásuvkový výsuv L/P  
 fioksin L/R  
 glisier sertar S/D
- čelní kování včetně šroubů L/P  
 zabezpečovacie zariadenie L/P + skrutky  
 zárszerkezet L/R + csavarok  
 dispozitiv de blocare S/D + suruburi

NL = jmenovitá délka výsuvu  
 nominálna dĺžka výsuvu  
 névleges fióksínhossz  
 lungimea nominală a glisierei

AV = ztráta výsuvu  
 strata výsuvu  
 kihúzás vesztesség  
 pierdereea extensiei

Poznámka pro montáž: pro správnou funkci zásuvky nesmí šířka zásuvky překročit jmenovitou délku výsuvu.  
 Poznámka pre montáž: pre správnú funkciu zásuvky nesmie šírka zásuvky prekročiť nominálnu dĺžku výsuvu.  
 Szerelési információk: a fiók megfelelő működéséhez a fiók szélessége nem haladhatja meg a névleges fióksínhosszat.  
 Informații de montare: pentru o funcționare corectă a sertarului, lățimea sertarului nu poate depăși lungimea nominală a glisierei.

	L mm	AV mm	kg			
PB-0SHX-250-A	250	16	35	plný úplný teljes complet	pozinkovaný pozinkovaný galvanizált galvanizat	ocel ocel acél oțel
PB-0SHX-270-A	270					
PB-0SHX-300-A	300					
PB-0SHX-350-A	350					
PB-0SHX-400-A	400					
PB-0SHX-450-A	450					
PB-0SHX-500-A	500					
PB-0SHX-550-A	550					
PB-0SHX-600-A	600					



Skrytý výsuv s tlmením GCHX18-H  
 Skrytý výsuv s tlmením GCHX18-H  
 Rejtett fióksin, csillapított GCHX18-H  
 Glisiera sub sertar cu amortizare GCHX18-H



okraj skříňky / okraj skrinky / szekrény széle / marginea dulapului

NL

300

350

400

450

500

550

9 9 9 9 64

37 128 96 23





- zásuvkový výsuv L/P  
 zásuvkový výsuv L/P  
 fióksin L/R  
 glisier sertar S/D
- železní kování včetně šroubů L/P  
 zabezpečovací zariadenie L/P  
 + skrutky  
 zárszerkezet L/R + csavarok  
 dispozitiv de blocare S/D +  
 suruburi

AV

NL = jmenovitá délka výsuvu  
 nominálna dĺžka výsuvu  
 névleges fióksínhossz  
 lungimea nominală a glisierei

AV = ztráta výsuvu  
 strata výsuvu  
 kihúzás vesztesség  
 pierderea extensiei

Poznámka pro montáž: pro správnou funkci zásuvky nesmí šířka zásuvky překročit jmenovitou délku výsuvu.  
 Poznámka pre montáž: pre správnu funkciu zásuvky nesmie šírka zásuvky prekročiť nominálnu dĺžku výsuvu.  
 Szerelési információk: a fiók megfelelő működéséhez a fiók szélessége nem haladhatja meg a névleges fióksínhosszat.  
 Informații de montare: pentru o funcționare corectă a sertarului, lățimea sertarului nu poate depăși lungimea nominală a glisierii.

	$L$ mm	$AV$ mm		$kg$ +		
PB-GCHX18-300-H	300	88,5 mm	částečný čistočný részleges parțial	25 kg	pozinkovaný pozinkovaný galvanizált galvanizat	ocel ocel acél oțel
PB-GCHX18-350-H	350					
PB-GCHX18-400-H	400	118,5 mm				
PB-GCHX18-450-H	450					
PB-GCHX18-500-H	500					
PB-GCHX18-550-H	550					

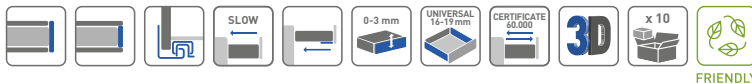

Skrýtý výsuv s tlumením Modern Slide Pro push to open  
 Skrytý výsuv s tlmením Modern Slide Pro push to open  
 Rejtett fióksin, csillapított Modern Slide Pro push to open  
 Glisiera sub sertar cu amortizare Modern Slide Pro push to open



okraj skříňky / okraj skrinky / szekrény széle / marginea dulapului

2. PB-SYNCHROP20-PRO L-1100 mm

NL = jmenovitá délka výsuvu  
 nominální délka výsuvu  
 névleges fióksínhossz  
 lungimea nominală a glisierii

AV = ztráta výsuvu  
 strata výsuvu  
 kihúzás vesztéség  
 pierdere extensiei

Poznámka pro montáž: pro správnou funkci zásuvky nesmí šířka zásuvky překročit jmenovitou délku výsuvu.  
 Poznámka pre montáž: pre správnu funkciu zásuvky nesmie šírka zásuvky prekročiť nominálnu dĺžku výsuvu.  
 Szerelési információk: a fiók megfelelő működéséhez a fiók szélessége nem haladhatja meg a névleges fióksínhosszat.  
 Informații de montare: pentru o funcționare corectă a sertarului, lățimea sertarului nu poate depăși lungimea nominală a glisierii.

	L (mm)	AV (mm)			
PB-3D0FPO18-250-PRO	250	5	plný úplný teljes complet	35	pozinkovaný pozinkovaný galvanizált galvanizat
PB-3D0FPO18-300-PRO	300	-			
PB-3D0FPO18-350-PRO	350	-			
PB-3D0FPO18-400-PRO	400	-			
PB-3D0FPO18-450-PRO	450	-			
PB-3D0FPO18-500-PRO	500	-			
PB-3D0FPO18-550-PRO	550	-			
PB-3D0FPO18-600-PRO	600	-			
PB-SYNCHROP20-PRO	1100	-			ocel ocel acel oțel
PB-SYNCHROP20-PRO-MOC	-	-			plast / plast / műanyag / plastic

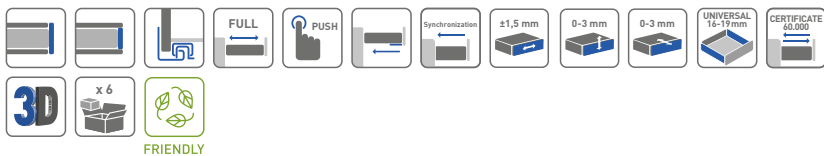

Konzola pro soklové zásuvky MORE SPACE  
 Konzola pre soklové zásuvky MORE SPACE  
 MORE SPACE mennyezeti fiók tartó  
 Suport pentru sertarele cu soclu MORE SPACE



PB-WSPCOK	pozinkovaný / pozinkovaný / galvanizált / galvanizat	ocel / ocel / acél / oțel
-----------	--	---------------------------

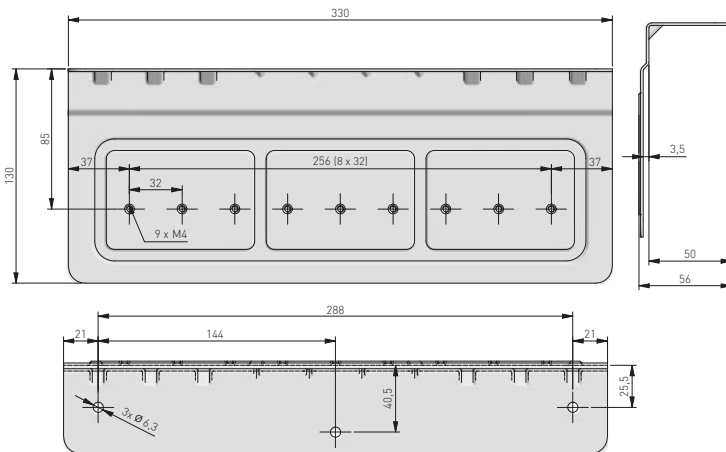

Skrýtý výsuv Push to open 0FP018  
 Skrytý výsuv Push to open 0FP018  
 Rejtett fióksin push 2 open-es 0FP018  
 Glisiera sub sertar cu push 2 open 0FP018









Lze použít se stabilizátorem PB-D-P20STAB  
 Možnost použití so stabilizátorem PB-D-P20STAB  
 PB-D-P20STAB stabilizátorral hasznáható  
 Poate fi utilizat cu stabilizatorul PB-D-P20STAB

okraj skříňky / okraj skrinky / szekrény széle / marginea dulapului

NL = jmenovitá délka výsuvu  
 nominální délka výsuvu  
 névleges fióksínhossz  
 lungimea nominală a glisierii

AV = ztráta výsuvu  
 străta výsuvu  
 kihúzás veszteség  
 pierdere extensiei

Poznámka pro montáž: pro správnou funkci zásuvky nesmí šířka zásuvky překročit jmenovitou délku výsuvu.  
 Poznámka pre montáž: pre správnú funkciu zásuvky nesmie šírka zásuvky prekročiť nominálnu dĺžku výsuvu.  
 Szerelési információk: a fiók megfelelő működéséhez a fiók szélessége nem haladhatja meg a névleges fióksínhosszat.  
 Informații de montare: pentru o funcționare corectă a sertarului, lățimea sertarului nu poate depăși lungimea nominală a glisierii.

		 L mm	 AV mm				
PB-0FP018-250		250	26	plný úplný teljes complet	25	pozinkovaný pozinkovaný galvanizált galvanizat	ocel ocel acél oțel
PB-0FP018-300		300					
PB-0FP018-350		350					
PB-0FP018-400		400					
PB-0FP018-450		450					
PB-0FP018-500		500					
PB-0FP018-550		550					
PB-0FP018-600		600					





Skrytý výsuv s tlumením GCHX-H  
 Skrytý výsuv s tlmením GCHX-H  
 Rejtett fióksín, csillapított GCHX-H  
 Glisiera sub sertar cu amortizare GCHX-H





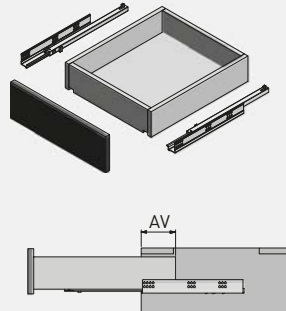
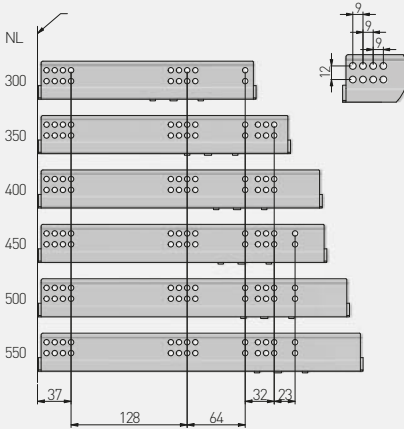



okraj skříňky / okraj skrinky / szekrény széle / marginea dulapului



NL = jmenovitá délka výsuvu  
 nominálna dĺžka výsuvu  
 névleges fióksínhossz  
 lungimea nominală a glisierei

AV = ztráta výsuvu  
 strata výsuvu  
 kiňzés-vesztéség  
 pierdereea extensiei

Poznámka pro montáž: pro správnou funkci zásuvky nesmí šířka zásuvky překročit jmenovitou délku výsuvu.  
 Poznámka pre montáž: pre správnú funkciu zásuvky nesmie šírka zásuvky prekročiť nominálnu dĺžku výsuvu.  
 Szerelési információk: a fiók megfelelő működéséhez a fiók szélessége nem haladhatja meg a névleges fióksínhosszat.  
 Informații de montare: pentru o funcționare corectă a sertarului, lățimea sertarului nu poate depăși lungimea nominală a glisierii.

		 L mm	 AV mm			
PB-G10HX300-H		300	83	25	pozinkovaný pozinkovaný galvanizált galvanizát	ocel ocel oțel oțel
PB-G10HX350-H		350				
PB-G10HX450-H		450				
PB-G10HX500-H		500	111			
PB-G10HX550-H		550				

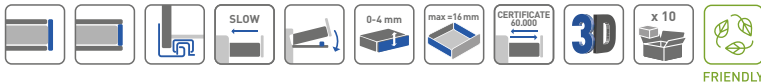

Kuličkový celovýšuv H53  
 Guličkový plnovýšuv H53  
 Golyós fióksin H53  
 Glisa cu bite H53

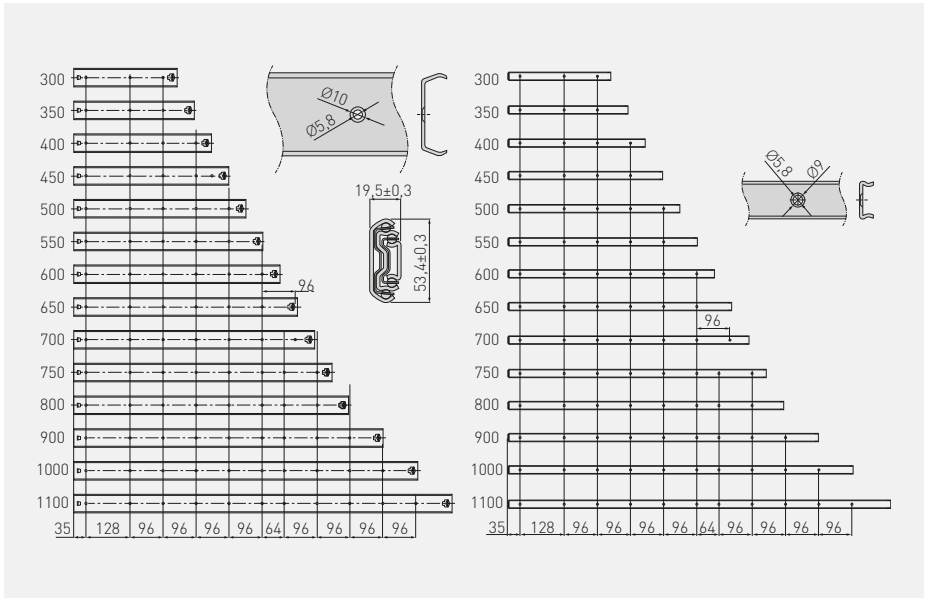

	L mm	AV mm	kg				L mm	AV mm	kg					
PK-0-H53-300	300	-					PK-0-H53-650	650	-					
PK-0-H53-350	350	-					PK-0-H53-700	700	-					
PK-0-H53-400	400	-	100	plný úplný teljes complet	100	pozinkovaný pozinkovaný galvanizált galvanizát	PK-0-H53-750	750	-	100	plný úplný teljes complet	100		
PK-0-H53-450	450	-					PK-0-H53-800	800	-				pozinkovaný pozinkovaný galvanizált galvanizát	
PK-0-H53-500	500	-					PK-0-H53-900	900	-					ocel ocel acél oțel
PK-0-H53-550	550	-					PK-0-H53-1000	1000	-					
PK-0-H53-600	600	-					PK-0-H53-1100	1100	-					





Kuličkový výsuv VERSALITE PRO H45, systém push to open a pomalé zavírání  
 Guličkový výsuv VERSALITE PRO H45, systém push to open a pomalé zatváranie  
 Golyós fioksin VERSALITE PRO H45 fékes és push 2 open-es  
 Glisiera cu bile VERSALITE PRO H45 cu amortizare si push 2 open

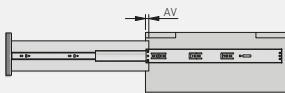
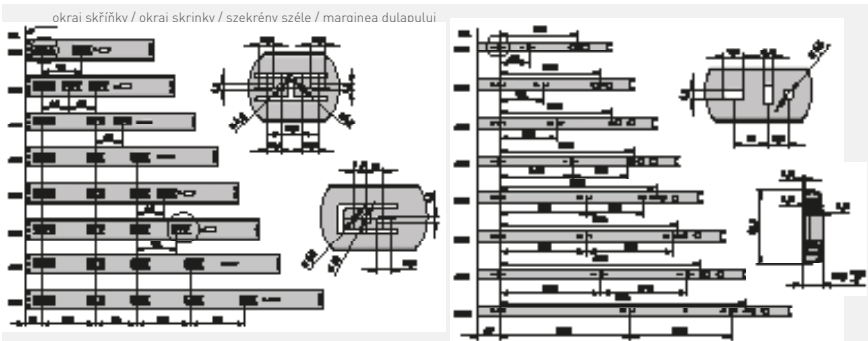

NL = jmenovitá délka výsuvu  
 nominálna dĺžka výsuvu  
 névleges fióksínhsz  
 lungimea nominală a glisierei

AV = ztráta výsuvu  
 strata výsuvu  
 kihúzás veszteség  
 pierdereea extensiei

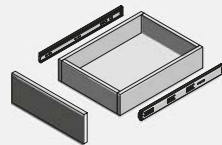

Poznámka pro montáž: pro správnou funkci zásuvky nesmí šířka zásuvky překročit jmenovitou délku výsuvu.  
 Poznámka pre montáž: pre správnú funkciu zásuvky nesmie šírka zásuvky prekročiť nominálnu dĺžku výsuvu.  
 Szerelési információk: a fiók megfelelő működéséhez a fiók szélessége nem haladhatja meg a névleges fióksínhszszat.  
 Informații de montare: pentru o funcționare corectă a sertarului, lățimea sertarului nu poate depăși lungimea nominală a glisierii.

	L mm	AV mm		kg		
PK-L-P20-H45-300	300	52	plný úplný teljes complet	30	pozinkovaný pozinkovaný galvanizált galvanizat	ocel ocel acél oțel
PK-L-P20-H45-350	350	35				
PK-L-P20-H45-400	400	20				
PK-L-P20-H45-450	450	4				
PK-L-P20-H45-500	500					
PK-L-P20-H45-550	550					
PK-L-P20-H45-600	600					
PK-L-P20-H45-700	700					





Kuličkový celovýsuv VersalitePlus+  
 Guličkový plnovýsuv VersalitePlus+  
 Golyós fióksín VersalitePlus+  
 Glisa cu bile VersalitePlus+



okraj skříňky / okraj skrinky / szekrény széle / marginea dulapului

NL = jmenovitá délka výsuvu  
 nominálna dĺžka výsuvu  
 névteljes fióksínhossz  
 lungimea nominală a glisierii

AV = ztráta výsuvu  
 strata výsuvu  
 kihúzás veszteség  
 pierdere extensiei

Poznámka pro montáž: pro správnou funkci zásuvky nesmí šířka zásuvky překročit jmenovitou délku výsuvu.  
 Poznámka pre montáž: pre správnou funkciu zásuvky nesmie šírka zásuvky prekročiť nominálnu dĺžku výsuvu.  
 Szerelési információk: a fiók megfelelő működéséhez a fiók szélessége nem haladhatja meg a névteljes fióksínhosszat.  
 Informații de montare: pentru o funcționare corectă a sertarului, lățimea sertarului nu poate depăși lungimea nominală a glisierii.



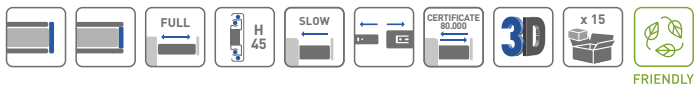



	L mm	AV mm		kg		
PK-L-H45-250-B	250	52	plný úplný teljes complet	40		ocel acél oțel
PK-L-H45-300-B	300	4				
PK-L-H45-350-B	350					
PK-L-H45-400-B	400					
PK-L-H45-450-B	450					
PK-L-H45-500-B	500					
PK-L-H45-550-B	550					
PK-L-H45-600-B	600					

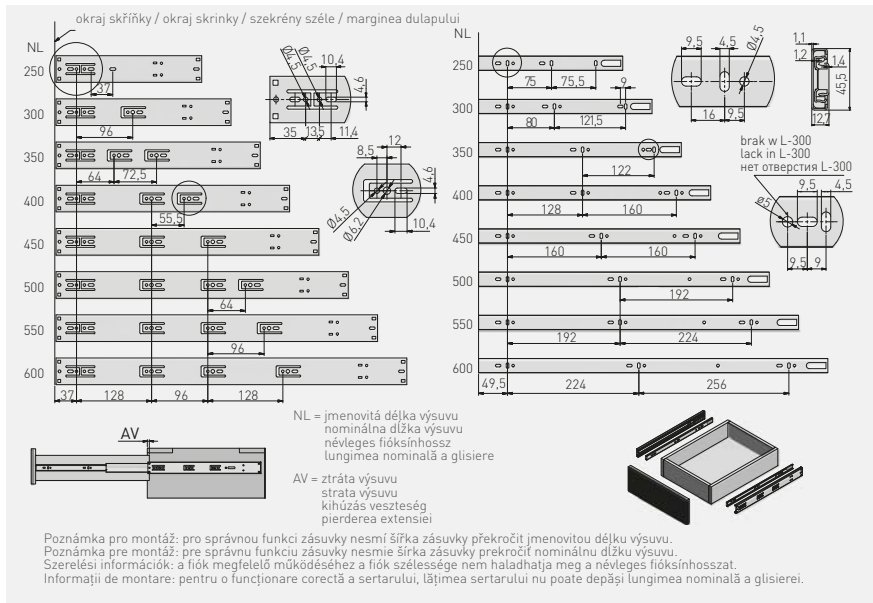



Kuličkový výsuv H45 s tlumením VERSALITE\*  
 Guličkový výsuv H45 s tlumením VERSALITE\*  
 Golyós fióksin VERSALITE H45 fékes\*  
 Glisiera cu bile VERSALITE H45 cu amortizare\*



		 L mm	 AV mm		 kg		
PK-L-H45-250-A		250**	55	plný úplný teljes complet	30		ocel ocel acél oțel
PK-L-H45-300-A		300	15				
PK-L-H45-350-A		350	5				
PK-L-H45-400-A		400					
PK-L-H45-450-A		450	0				
PK-L-H45-500-A		500					
PK-L-H45-550-A		550					
PK-L-H45-600-A		600					

\*K dispozicii pro speciální objednávky / K dispozicii na speciálne objednávky / Külön megrendelésben kapható / Disponibil pentru comenzi speciale



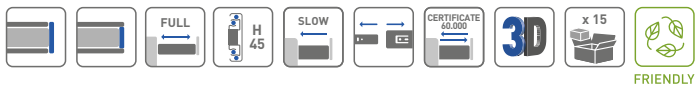



\*Bez úplného výsuvu / Bez úplného výsuvu / Nem teljes kihúzás / Extensie completă

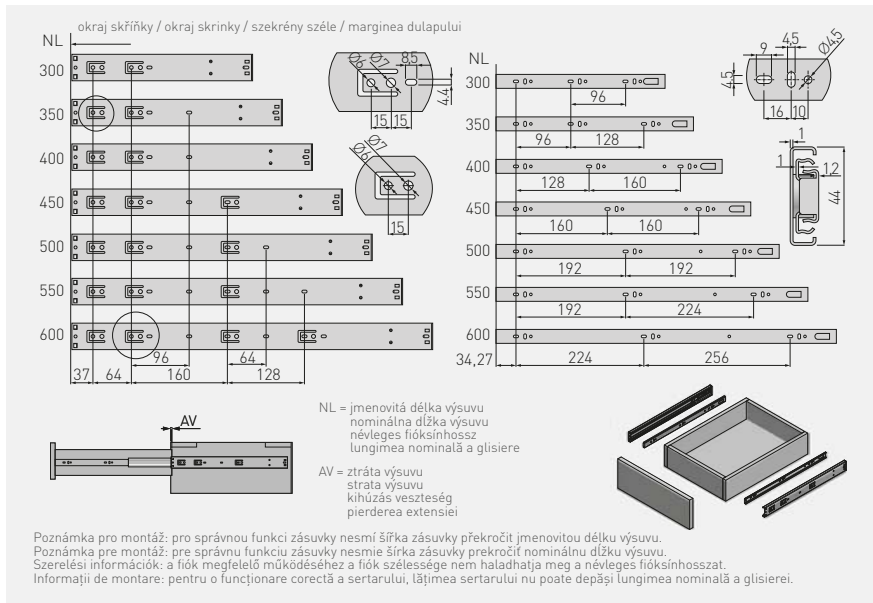



Kuličkový výsuv VERSALITE LIGHT s tlumením dorazu H45  
 Guličkový výsuv VERSALITE LIGHT s tlumením H45  
 Golyós fióksin VERSALITE LIGHT H45 fékes  
 Glisiera cu bile VERSALITE LIGHT H45 cu amortizare



		 L mm	 AV mm			
PK-L-H45-300-GX		300*	50	plný úplný teljes complet	25	pozinkovaný pozinkovaný galvanizált
PK-L-H45-350-GX		350	20			
PK-L-H45-400-GX		400	-			
PK-L-H45-450-GX		450				
PK-L-H45-500-GX		500				
PK-L-H45-550-GX		550				
PK-L-H45-600-GX		600				

\*\*Bez úplného výsuvu / Bez úplného výsuvu / Nem teljes kihűzésű / Extensie completă

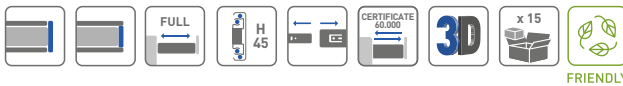

Kuličkový výsuv se zamozavíráním H45  
 Guličkový výsuv so samozavíráním H45  
 Golyós fioksin önbehuzós H45  
 Glisiera cu bile cu închidere automată H45











NL okraj skřínky / okraj skrinky / szekrény széle / marginea dulapului

NL = jmenovitá délka výsuvu  
 nominálna dĺžka výsuvu  
 névleges fióksínossz  
 lungimea nominală a glisierei

AV = ztráta výsuvu  
 strata výsuvu  
 kihúzás veszteség  
 pierdere a extensiei

Poznámka pro montáž: pro správnou funkci zásuvky nesmí šířka zásuvky překročit jmenovitou délku výsuvu.  
 Poznámka pre montáž: pre správnou funkciu zásuvky nesmie šírka zásuvky prekročiť nominálnu dĺžku výsuvu.  
 Szerelési információk: a fiók megfelelő működéséhez a fiók szélessége nem haladhatja meg a névleges fióksínosszat.  
 Informații de montare: pentru o funcționare corectă a sertarului, lățimea sertarului nu poate depăși lungimea nominală a glisierii.

		 L mm	 AV mm		 kg				
PK-S-H45-250		250	22	plný úplný teljes complet	35		pozinkovaný pozinkovaný galvanizált galvanizat	ocel ocel acél oțel	15
PK-S-H45-300		300							
PK-S-H45-350		350							
PK-S-H45-400		400							
PK-S-H45-450		450							
PK-S-H45-500		500							
PK-S-H45-550		550							10
PK-S-H45-600		600							
PK-S-H45-650		650							
PK-S-H45-700		700							



Kuličkový výsuv H45 PRESTIGE  
 Guličkový výsuv H45 PRESTIGE  
 Golyós fióksin H45 PRESTIGE  
 Glisiera cu bile H45 PRESTIGE

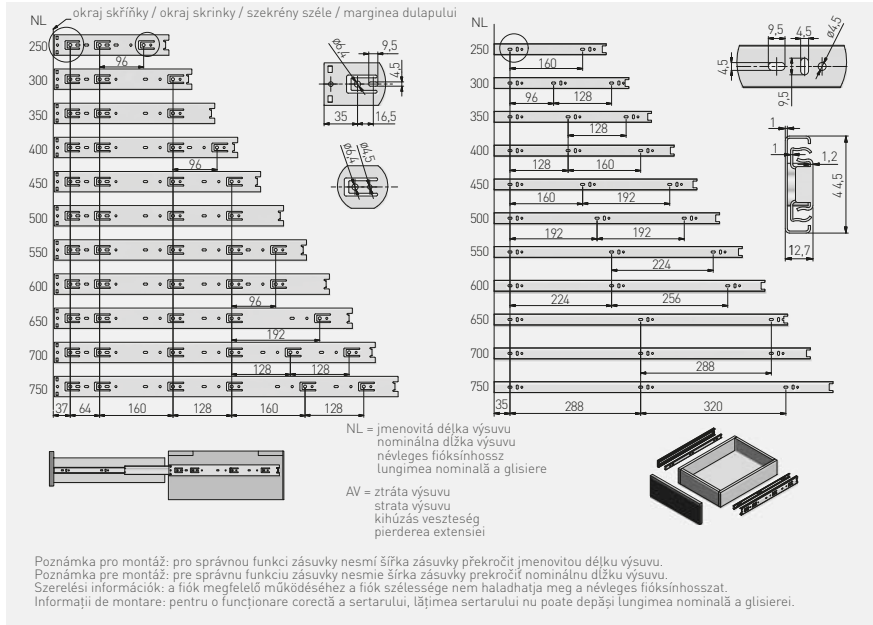



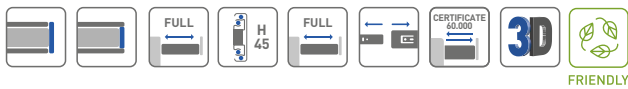

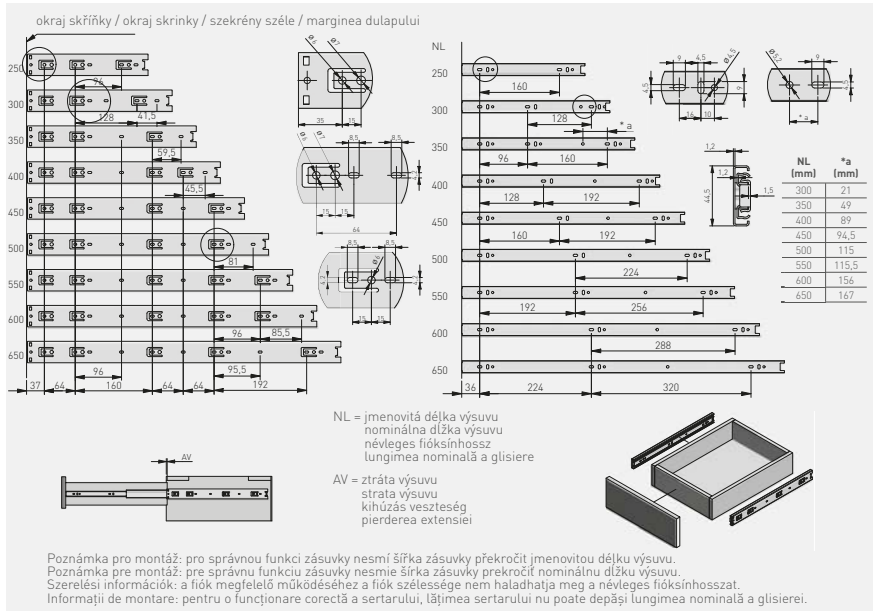

	L mm	AV mm	kg 1				
PK-0-H45-250	250	-	35	plný úplný teljes complet	pozinkovaný pozinkovaný galvanizált galvanizat	ocel ocel acél oțel	15
PK-0-H45-300	300						
PK-0-H45-350	350						
PK-0-H45-400	400						
PK-0-H45-450	450						
PK-0-H45-500	500						
PK-0-H45-550	550						
PK-0-H45-600	600						10
PK-0-H45-700	700						



Kuličkový výsuv H45 PRO  
 Guličkový výsuv H45 PRO  
 Golyós fióksin H45 PRO  
 Glisiera cu bile H45 PRO



		 L mm	 AV mm					
PK-PRO-H45-250		250	5	-	50	pozinkovaný pozinkovaný galvanizált galvanizat	oceľ oceľ acél oțel	15
PK-PRO-H45-300		300						
PK-PRO-H45-350		350						
PK-PRO-H45-400		400						
PK-PRO-H45-450		450						
PK-PRO-H45-500		500						
PK-PRO-H45-550		550						
PK-PRO-H45-600		600						
PK-PRO-H45-650		650						

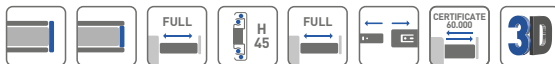



Kuličkový výsuv Push to open H45 GX  
 Guličkový výsuv Push to open H45 GX  
 Golyós fióksin H45 GX push 2 open-es  
 Glisiera cu bile H45 GX cu push 2 open



Lze použít se stabilizátorem PB-D-P20STAB  
 Možnost použít so stabilizátorom  
 PB-D-P20STAB  
 PB-D-P20STAB stabilizátorral használható  
 Poate fi utilizat cu stabilizatorul  
 PB-D-P20STAB

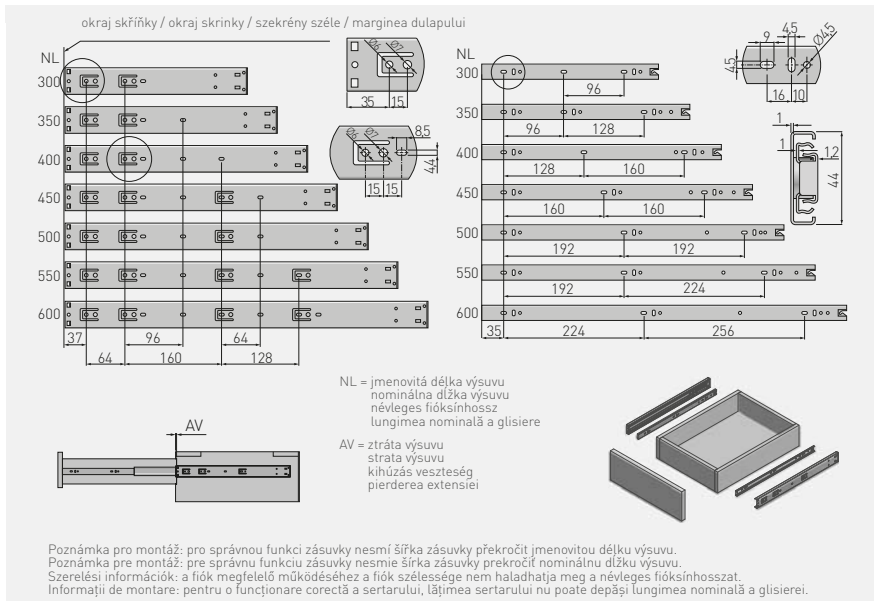





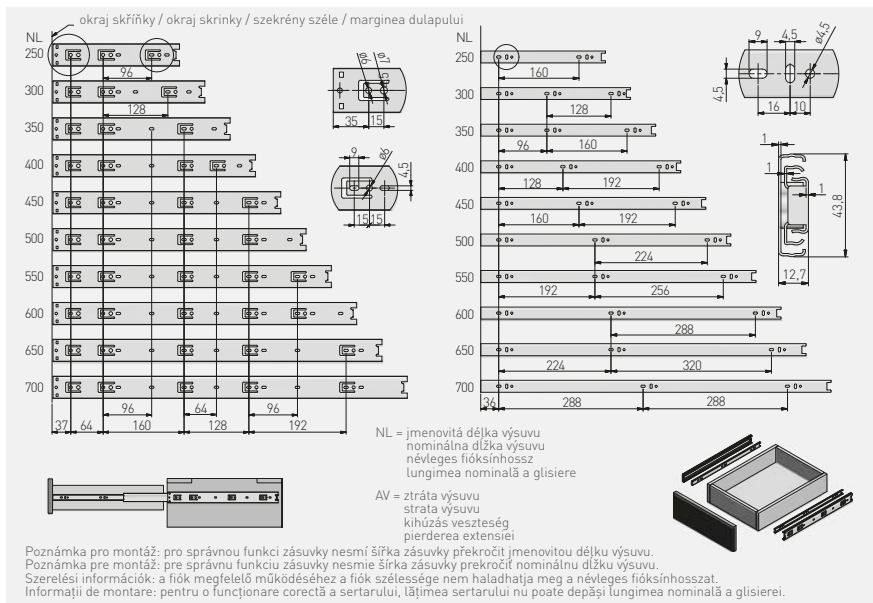

	L mm	AV mm		kg		
PK-P-H45-300-GX	300*	30	plný úplný teljes complet	25	pozinkovaný galvanizált	ocel acél oțel
PK-P-H45-350-GX	350					
PK-P-H45-400-GX	400					
PK-P-H45-450-GX	450					
PK-P-H45-500-GX	500					
PK-P-H45-550-GX	550					
PK-P-H45-600-GX	600					

\*Bez úplného výsuvu / Bez úplného výsuvu / Nem teljes kihűzésű / Extensie completă



Kuličkový výsuv H45 GX1  
 Guličkový výsuv H45 GX1  
 Golyós fióksin H45 GX1  
 Glisiera cu bile H45 GX1



		 L mm	 AV mm	 kg 1		
PK-0H45250GX1		250	5	30	pozinkovaný pozinkovaný galvanizált	ocel ocel acél oțel
PK-0H45300GX1		300				
PK-0H45350GX1		350				
PK-0H45400GX1		400				
PK-0H45450GX1		450				
PK-0H45500GX1		500				
PK-0H45550GX1		550				
PK-0H45600GX1		600				
PK-0H45650GX1		650				
PK-0H45700GX1		700				



Kuličkový výsuv H45 HK  
 Guličkový výsuv H45 HK  
 Golyós fióksin H45 HK  
 Glisiera cu bile H45 HK

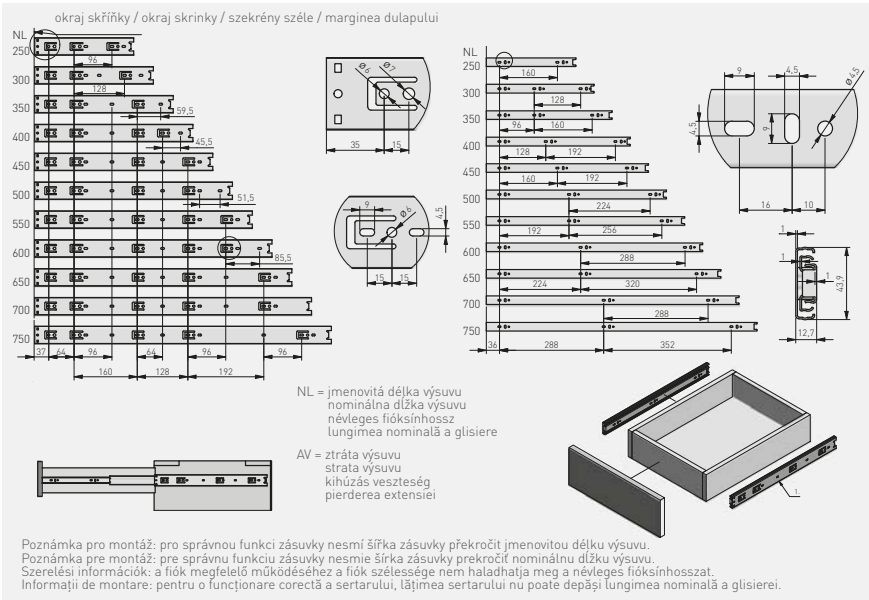

		mm	mm	kg		
PK-0H45250HK		250	5	30	pozinkovaný pozinkovaný galvanizált galvanizat	ocel ocel acél oțel
PK-0H45300HK		300				
PK-0H45350HK		350				
PK-0H45400HK		400				
PK-0H45450HK		450				
PK-0H45500HK		500				
PK-0H45550HK		550				
PK-0H45600HK		600				
PK-0H45650HK		650				
PK-0H45700HK		700				
PK-0H45750HK		750				

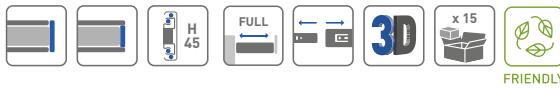



Kuličkový výsuv H45 GX2-A  
 Guličkový výsuv H45 GX2-A  
 Golyós fióksin H45 GX2-A  
 Glisiera cu bile H45 GX2-A

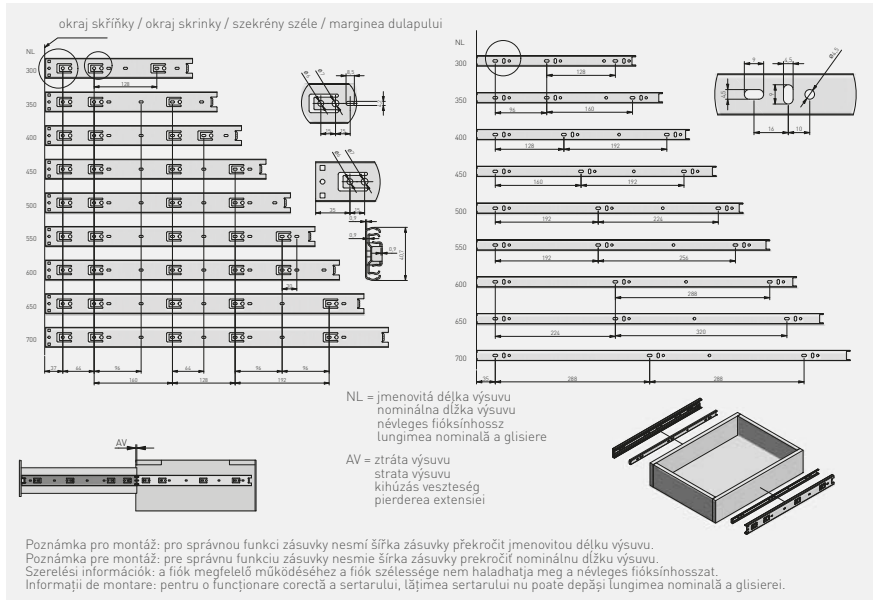

	L mm	AV mm		kg		
PK-0H45300GX2-A	300					
PK-0H45350GX2-A	350					
PK-0H45400GX2-A	400					
PK-0H45450GX2-A	450					
PK-0H45500GX2-A	500					
PK-0H45550GX2-A	550					
PK-0H45600GX2-A	600					
PK-0H45650GX2-A	650					
PK-0H45700GX2-A	700					
			plný úplný teljes complet	25	pozinkovaný pozinkovaný galvanizált galvanizat	ocel ocel acél oțel



Kuličkový výsuv H35  
 Guličkový výsuv H35  
 Golyós fióksin H35  
 Glisiera cu bile H35



okraj skříňky / okraj skrinky / szekrény széle / marginea dulapului

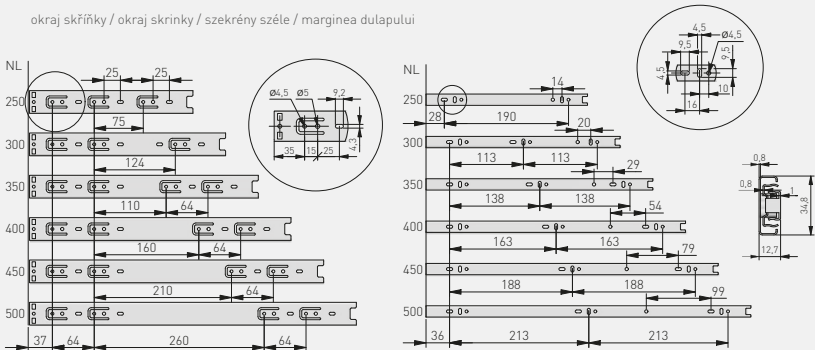





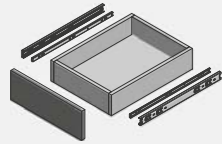

NL = jmenovitá délka výsuvu  
 nominálna dĺžka výsuvu  
 névleges fióksínhossz  
 lungimea nominală a glisierii

AV = ztráta výsuvu  
 strata výsuvu  
 kihúzás veszteség  
 pierdere de extensie



Poznámka pro montáž: pro správnou funkci zásuvky nesmí šířka zásuvky překročit jmenovitou délku výsuvu.  
 Poznámka pre montáž: pre správnu funkciu zásuvky nesmie šírka zásuvky prekročiť nominálnu dĺžku výsuvu.  
 Szerelési információk: a fiók megfelelő működéséhez a fiók szélessége nem haladhatja meg a névleges fióksínhosszat.  
 Informații de montare: pentru o funcționare corectă a sertarului, lățimea sertarului nu poate depăși lungimea nominală a glisierii.

		 L mm	 AV mm		 kg t		
	PK-0H35-2500	300	4	plný úplný teljes complet	20	pozinkovaný pozinkovaný galvanizált galvanizat	ocel ocel acél oțel
	PK-0H35-3000	300					
	PK-0H35-3500	350					
	PK-0H35-4000	400					
	PK-0H35-4500	450					
	PK-0H35-5000	500					



Kuličkový výsuv H35  
 Guličkový výsuv H35  
 Golyós fióksin H35  
 Glisiera cu bile H35

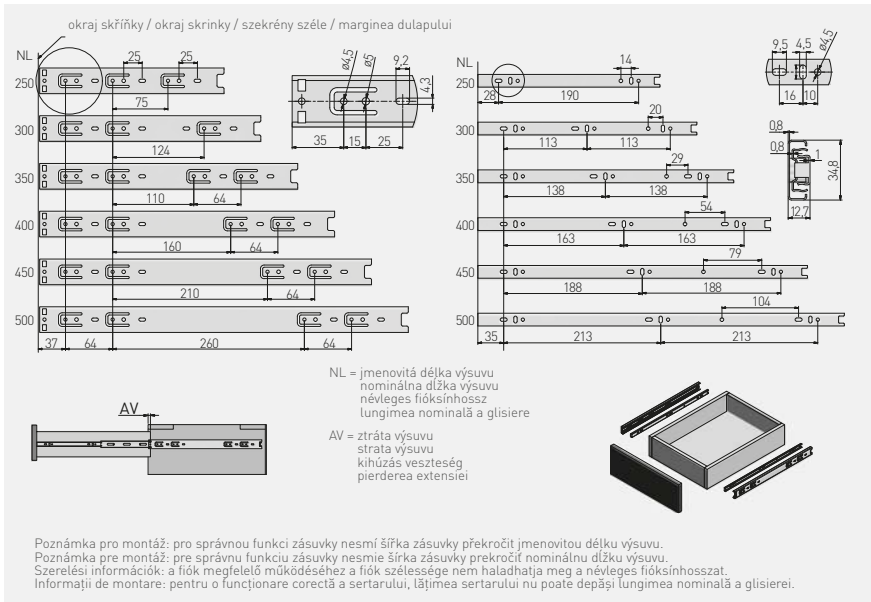

	L mm	AV mm		kg			
PK-0-H35-250	250	4	plný úplný teljes complet	20	pozinkovaný pozinkovaný galvanizált galvanizat	ocel ocel acél oțel	20
PK-0-H35-300	300						
PK-0-H35-350	350						
PK-0-H35-400	400						
PK-0-H35-450	450						
PK-0-H35-500	500						



Kuličkový výsuv H35  
 Guličkový výsuv H35  
 Golyós fioksin H35  
 Glisiera cu bile H35











okraj skříňky / okraj skrinky / szekrény széle / marginea dulapului

NL = jmenovitá délka výsuvu  
 nominální délka výsuvu  
 névleges fioksinhossz  
 lungimea nominală a glisierii

AV = ztráta výsuvu  
 strata výsuvu  
 kihúzás veszteség  
 pierdereea extensiei

Poznámka pro montáž: pro správnou funkci zásuvky nesmí šířka zásuvky překročit jmenovitou délku výsuvu.  
 Poznámka pre montáž: pre správnú funkciu zásuvky nesmie šírka zásuvky prekročiť nominálnu dĺžku výsuvu.  
 Szerelési információk: a fiók megfelelő működéséhez a fiók szélessége nem haladhatja meg a névleges fioksinhosszat.  
 Informații de montare: pentru o funcționare corectă a sertarului, lățimea sertarului nu poate depăși lungimea nominală a glisierii.

		 L mm	 AV mm		 kg			
PK-0-H35-2500L		250	4	plný úplný teljes complet	20	pozinkovaný pozinkovaný galvanizált galvanizat	ocel ocel acél oțel	30
PK-0-H35-3000L		300						20
PK-0-H35-3500L		350						20
PK-0-H35-4000L		400						20
PK-0-H35-4500L		450						20
PK-0-H35-5000L		500						20



Kuličkový výsuv H30  
 Guličkový výsuv H30  
 Golyós fióksin H30  
 Glisiera cu bile H30

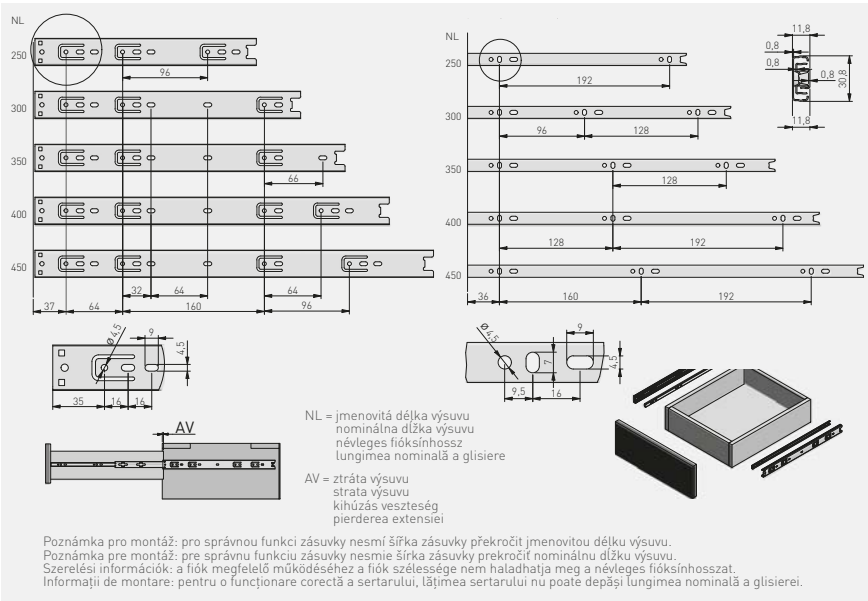





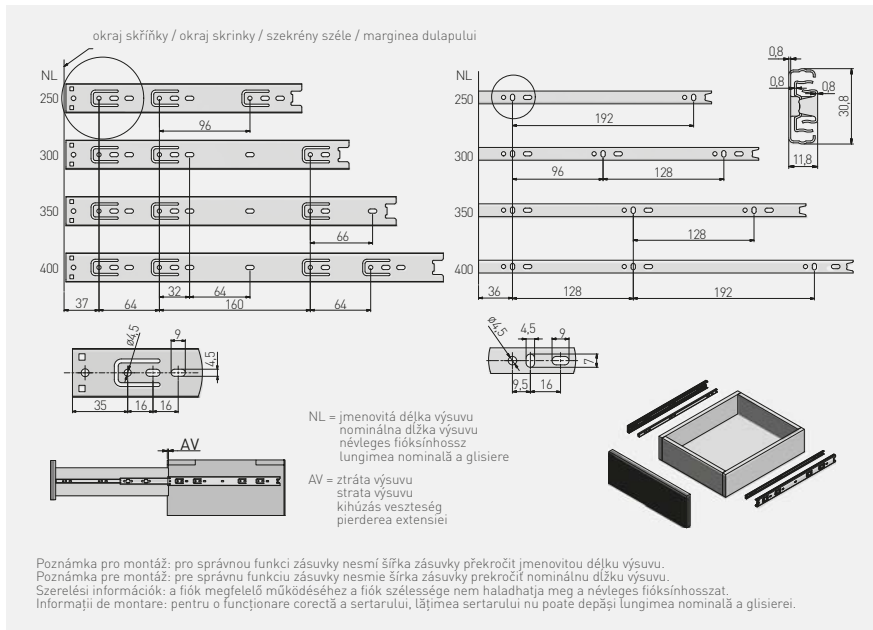

	L mm	AV mm		kg		
PK-0H30-2500	250	-	plný úplný teljes complet	15	pozinkovaný pozinkovaný galvanizált	ocel ocel acél oțel
PK-0H30-3000	300					
PK-0H30-3500	350					
PK-0H30-4000	400					
PK-0H30-4500	450					



Kuličkový výsuv H30  
 Guličkový výsuv H30  
 Golyós fióksin H30  
 Glisiera cu bile H30



		 L mm	 AV mm			
PK-0H30-2500-A		250	-	plný úplný teljes complet	15	galvanizovaná ocel galvanizovaná ocel horganyzott acél oțel galvanizat
PK-0H30-3000-A		300				
PK-0H30-3500-A		350				
PK-0H30-4000-A		400				



Kuličkový výsuv H27  
 Guličkový výsuv H27  
 Golyós fióksin H27  
 Glisiera cu bile H27

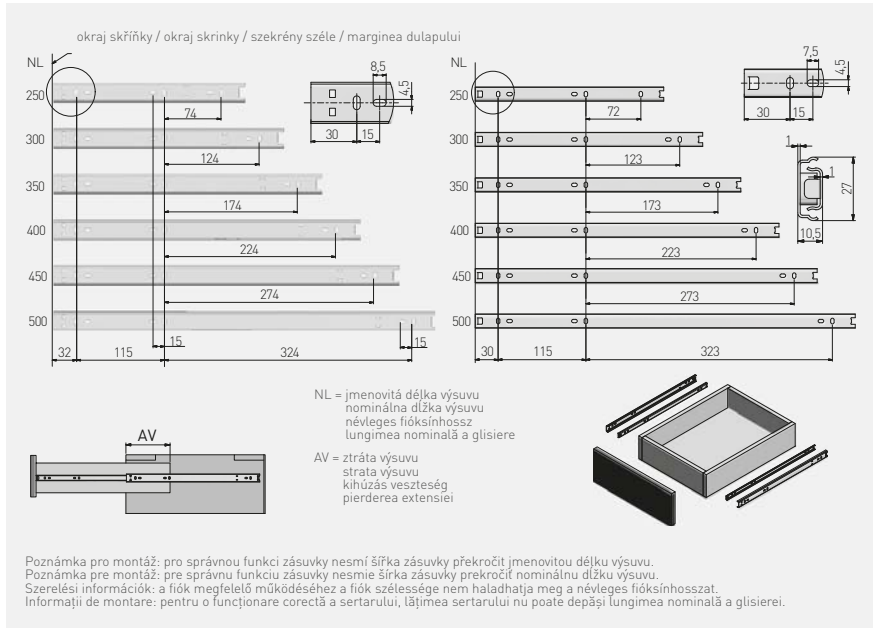



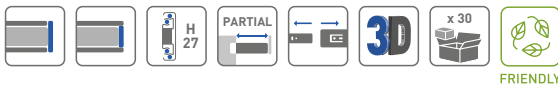

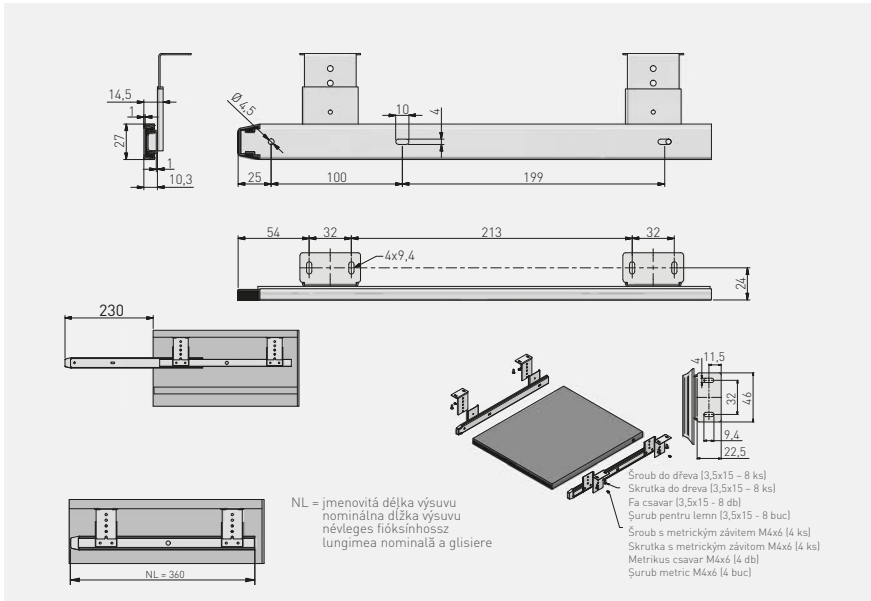

	 L mm	 AV mm		 kg		
PK-0H27-3000	300	109	částečný čiasťočný részleges parțial	15		pozinkovaný pozinkovaný galvanizált galvanizat
PK-0H27-3500	350	124				
PK-0H27-4000	400	134				
PK-0H27-4500	450	149				
PK-0H27-5000	500	184				



Kuličkový výsuv pro klávesnici H27  
 Gulíčkový výsuv pre klávesnicu H27  
 Golyós fióksin H27 klaviatura tartó  
 Glisiera cu bile pentru tastatura H27



					
PIK-0-000-027	360	částečný čiasočný részleges parțial	5	pozinkovaný pozinkovaný galvanizált galvanizat	ocel ocel acél oțel





Kuličkový výsuv H17  
 Guličkový výsuv H17  
 Golyós fióksin H17  
 Glisiera cu bile H17

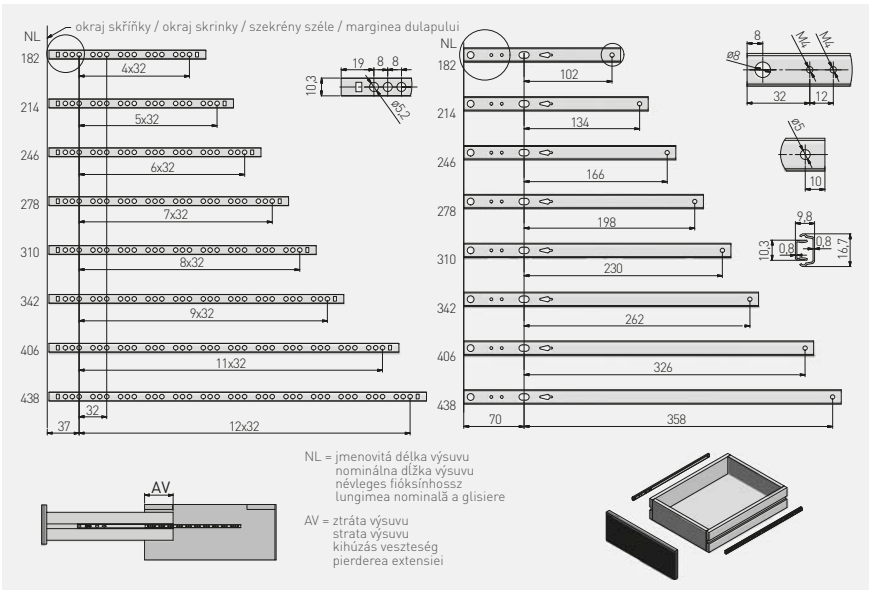

	NL mm	AV mm	10				
PK-0H17182XP	182	62	částečný čiasočný részleges parțial	10	pozinkovaný pozinkovaný galvanizált galvanizat	ocel ocel acél oțel	100
PK-0H17214XP	214	77					
PK-0H17246XP	246						
PK-0H17278XP	278						
PK-0H17310XP	310						
PK-0H17342XP	342						
PK-0H17406XP	406						
PK-0H17438XP	438						



Rolníčkový výsuv OB  
 Kolieskový výsuv OB  
 Görgös fióksin OB  
 Glisiera cu role OB

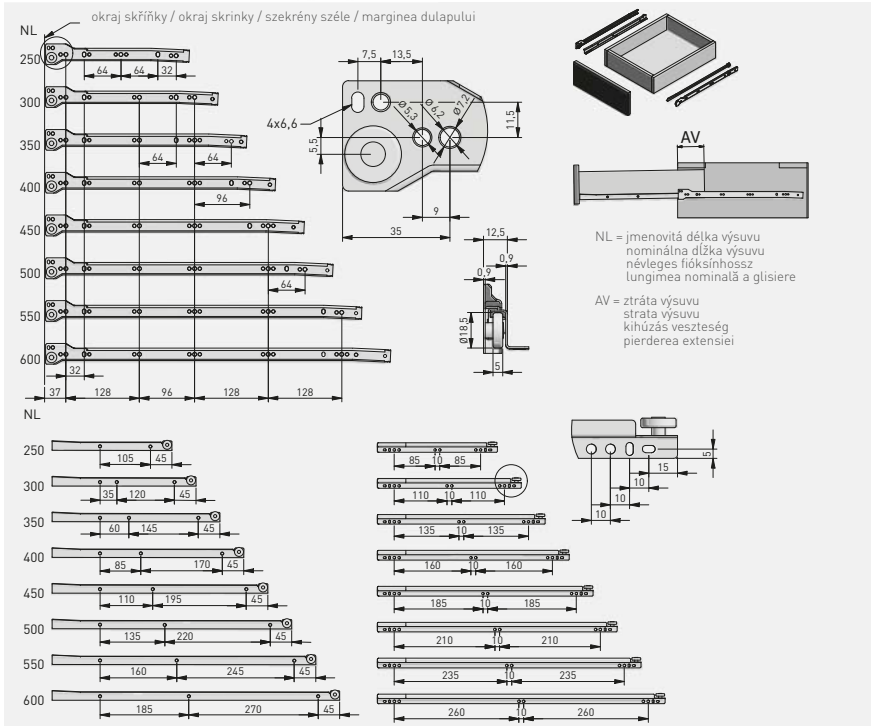

	L mm	AV mm	kg				L mm	AV mm	kg			
PR-OB-250-10	250						PR-OB-250-18*	250				
PR-OB-300-10	300						PR-OB-300-18*	300				
PR-OB-350-10	350	100					PR-OB-350-18*	350	100			
PR-OB-400-10	400						PR-OB-400-18*	400				
PR-OB-450-10	450						PR-OB-450-18*	450				
PR-OB-500-10	500	110					PR-OB-500-18*	500	110			
PR-OB-550-10	550	115					PR-OB-550-18*	550	115			
PR-OB-600-10	600	125					PR-OB-600-18*	600	125			
			25	bílá biela fehér alb	ocel ocel acél oțel				25	částečný částočný részleges parțial	šedá sivá szürke gri	ocel ocel acél oțel



Rolníčkový výsuv OB  
 Kolieskový výsuv OB  
 Görgös fióksin OB  
 Glisiera cu role OB



okraj skříňky / okraj skrinky / szekrény széle / marginea dulapului

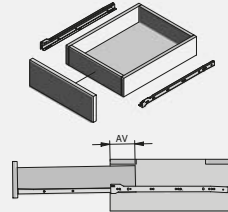
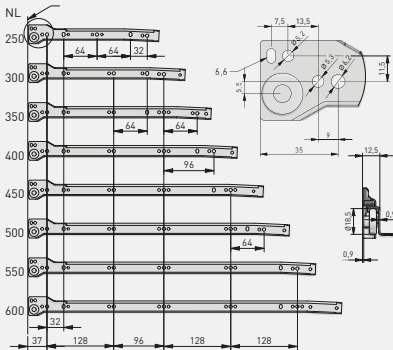

NL = jmenovitá délka výsuvu  
 nominálna dĺžka výsuvu  
 névleges fióksínhossz  
 lungimea nominală a glisierei

AV = ztráta výsuvu  
 strata výsuvu  
 kihúzás veszteség  
 pierdere extensiei

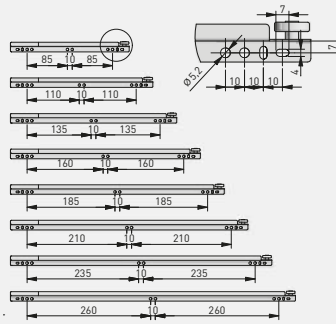
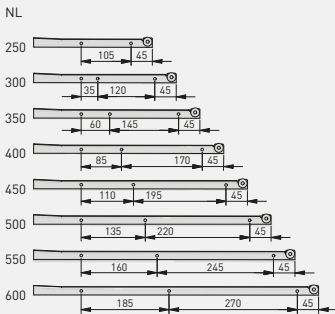

PR-OB-300-10-Z	300	100	částečný čiasťový részleges partial	20	bílám biela fehér ab	ocel ocel acél oțel
PR-OB-350-10-Z	350					
PR-OB-400-10-Z	400					
PR-OB-450-10-Z	450					
PR-OB-350-18-Z*	350					
PR-OB-450-80-Z	450					



Metalbox Prestige  
 Metalbox Prestige  
 Fémfiokoldal Metalbox MP  
 Glisiera cu role Metalbox MP



Přední montážní rozměry  
 Predné montážne rozmery  
 Első szerelési méretek  
 Dimensiuni de montare frontale

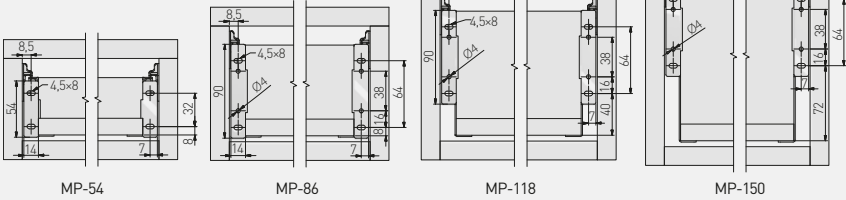

Montážní rozměry  
 Montážne rozmery  
 Szerelési méretek  
 Dimensiuni de montare

okraj skříňky / okraj skrinky / szekrény széle / marginea dulapului

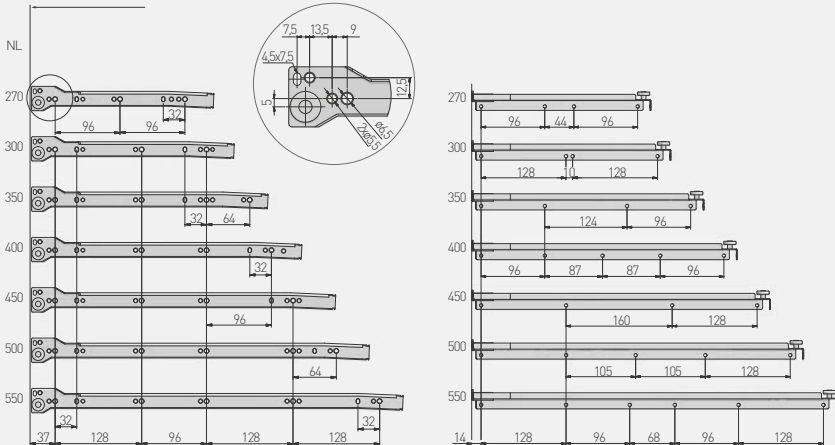



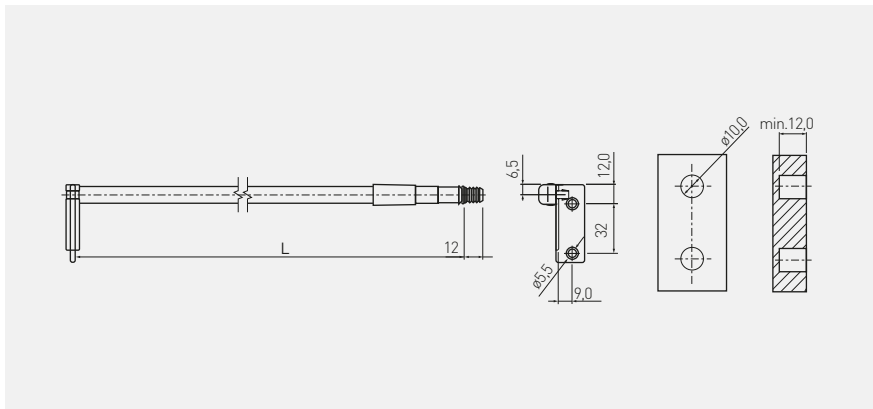

MP-054350-10	54	350	88	částečný částočný részleges parťial	25	lak lak lakk lac	bílám biela fehér alb	ocel ocel acél ořel									
MP-054400-10		400															
MP-054450-10		450															
MP-054500-10		500	98														
MP-054450-80		450															
MP-054500-80		500															
MP-086270-10	86	270	88				částečný částočný részleges parťial		25	lak lak lakk lac	bílám biela fehér alb	ocel ocel acél ořel					
MP-086300-10		300															
MP-086350-10		350															
MP-086400-10		400	98														
MP-086450-10		450															
MP-086500-10		500	118														
MP-086550-10		550															
MP-086350-80		350	88														
MP-086400-80		400	98														
MP-086450-80		450															
MP-086500-80		500															
MP-118350-10		118	350								88		částečný částočný részleges parťial	25	lak lak lakk lac	šedá sivá szürke gri	ocel ocel acél ořel
MP-118400-10	400		98														
MP-118450-10	450																
MP-118500-10	500																
MP-150270-10	150	270	88				částečný částočný részleges parťial		25	lak lak lakk lac	bílám biela fehér alb	ocel ocel acél ořel					
MP-150300-10		300															
MP-150350-10		350															
MP-150400-10		400	98														
MP-150450-10		450															
MP-150500-10		500	118														
MP-150550-10		550															
MP-150350-80		350	88														
MP-150400-80		400	98														
MP-150450-80		450															
MP-150500-80		500															

Podélný reling s držákom zad P/L  
 Pozdĺžny reling s držiakom zad P/L  
 Korlat hátfalrögzitövel METALBOX fémfokoldalokhoz ball/jobb  
 Lonjeron pt METALBOX cu connector stanga/dreapta



	 L mm	
RS-SZ-400-10	393 / 404	bílám biela fehér alb
RS-SZ-450-10	443 / 454	
RS-SZ-500-10	493 / 504	

L - skutečná délka (Lmin.; Lmax.) / L - skutočná dĺžka (Lmin.; Lmax.) / L - tényleges hossz (Lmin.; Lmax.) / L - lungimea reală (Lmin.; Lmax.)



Přídavný tlumič pro rolničkové výsuvy a metalboxy 350-550 mm  
 Přídavný tlmič pre kolieskové výsuvy a metalboxy 350-550 mm  
 Csillapító görgős fióksínekhez és METALBOX fémfiókoldalokhoz 350-550 mm  
 Amortizare pentru glisiere cu role si Metalbox 350-550 mm



AM-MBSOFT-P2	25	šedá sivá szürke gri	plast plast műanyag plastic

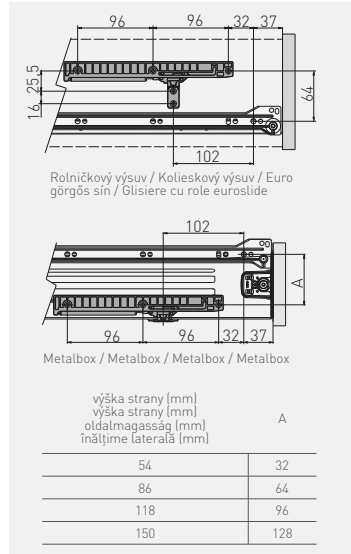

Stabilizační váleček pro zásuvky  
 Stabilizačný valček  
 Fiók stabilizátor  
 Stabilizator sertar

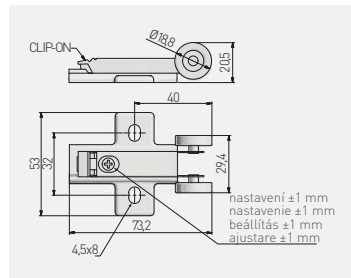

Pro zásuvky se systémem push to open  
 Pre zásuvky so systémom push to open  
 Nyomásra nyíló fiókokhoz  
 Pentru sertare cu deschidere push 2 open

PB-D-P20STAB	nikl / nikel / nikkel / nichel	ocel / ocel / acél / oțel



## AXIS PRO

Sada  
Sada  
Készlet  
Set

### SPOJOVACÍ DÍL ZADNÍHO PANELU

nizký / střední / vysoký  
antracitová / bílá

### DRŽIAK ZADNÉHO PANELU

nizký / střední / vysoký  
antracitová / bílá

### HÁTSÓ PANEL CSATLAKOZÓ

alacsony / középmagas / magas  
antracit / fehér

### CONECTOR PANOU SPATE

inferior / mediu / înalt  
antracit / alb

### KRYTKA OTVORU

antracitová / bílá

### KRYCÍ UZÁVER

antracitový / biely

### TAKARÓ SAPKA

antracit / fehér

### CAPAC

antracit / alb

### PŘEDNÍ SPOJOVACÍ DÍL + ŠROUBY

Držiak čela + skrutky  
ELŰLSŐ CSATLAKOZÓ + CSAVAROK  
CONNECTOR FRONT + ȘURUBURI

### VÝSUV

L = 300-550 mm

### VÝSUV

L = 300-550 mm

### CSÚSZÓ SÍN

L = 300-550 mm

### GLISIERA

L = 300-550 mm

ultra tenká bočnice  
ultra tenká bočnica zásuvky  
ultra vékony fiókdalák  
lateralele sertarelor foarte subțiri

### ZAJIŠŤOVACÍ

### MECHANISMUS

### ZÁSUVKY

antracitová / bílá

L = 300-550 mm

### ZAIŠTOVACÍ

### MECHANIZMUS

### ZÁSUVKY

antracitová / biela

L = 300-550 mm

### FIÓK ZÁRÓ

### MECHANIZMUSA

antracit / fehér

L = 300-550 mm

### MECANISM DE

### BLOCARE A

### SERTARELOR

antracit / alb

L = 300-550 mm





## AXIS PRO

Sada pro nízkou zásuvku A  
Sada pre nízku zásuvku A  
Alacsony fiók készlet A  
Set de sertare mici A

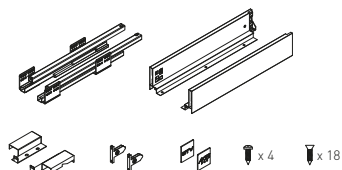

	L mm	kg			
PB-AXISPRO-KPL250A	250	40	antracitová antracitová antracit antracit	lak lak lakk lac	ocel ocel acél oțel
PB-AXISPRO-KPL300A	300				
PB-AXISPRO-KPL350A	350				
PB-AXISPRO-KPL400A	400				
PB-AXISPRO-KPL450A	450				
PB-AXISPRO-KPL500A	500				
PB-AXISPRO-KPL600A	600				
PB-AXISPRO-KPL250A1	250		biłam biela fehér alb		
PB-AXISPRO-KPL300A1	300				
PB-AXISPRO-KPL350A1	350				
PB-AXISPRO-KPL400A1	400				
PB-AXISPRO-KPL450A1	450				
PB-AXISPRO-KPL500A1	500				
PB-AXISPRO-KPL600A1	600				

## AXIS PRO

Sada pro střední zásuvku B  
Sada pre strednú zásuvku B  
Közepes fiók készlet B  
Set de sertare medii B

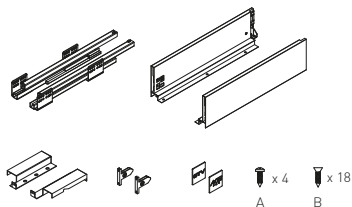

	L mm	kg			
PB-AXISPRO-KPL250B	250	40	antracitová antracitová antracit antracit	lak lak lakk lac	ocel ocel acél oțel
PB-AXISPRO-KPL300B	300				
PB-AXISPRO-KPL350B	350				
PB-AXISPRO-KPL400B	400				
PB-AXISPRO-KPL450B	450				
PB-AXISPRO-KPL500B	500				
PB-AXISPRO-KPL550B	550				
PB-AXISPRO-KPL600B	600				
PB-AXISPRO-KPL250B1	250		biłam biela fehér alb		
PB-AXISPRO-KPL300B1	300				
PB-AXISPRO-KPL350B1	350				
PB-AXISPRO-KPL400B1	400				
PB-AXISPRO-KPL450B1	450				
PB-AXISPRO-KPL500B1	500				
PB-AXISPRO-KPL550B1	550				
PB-AXISPRO-KPL600B1	600				

## AXIS PRO

Sada pro vysokou zásuvku C  
Sada pre vysokú zásuvku C  
Magas fiók készlet C  
Set de sertare înalte C

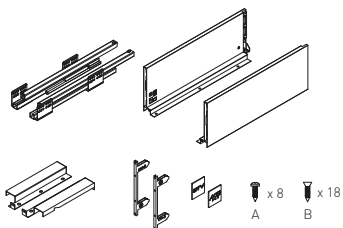

Model	Height (mm)	Color	Material	Material
PB-AXISPRO-KPL250C	250	40	antracitová antracitová antracit	lak lak lakk lac
PB-AXISPRO-KPL300C	300			
PB-AXISPRO-KPL350C	350			
PB-AXISPRO-KPL400C	400			
PB-AXISPRO-KPL450C	450			
PB-AXISPRO-KPL500C	500			
PB-AXISPRO-KPL550C	550	40	bílám biela fehér alb	ocel ocel ocel oțel
PB-AXISPRO-KPL600C	600			
PB-AXISPRO-KPL250C1	250			
PB-AXISPRO-KPL300C1	300			
PB-AXISPRO-KPL350C1	350			
PB-AXISPRO-KPL400C1	400			
PB-AXISPRO-KPL450C1	450	40	bílám biela fehér alb	ocel ocel ocel oțel
PB-AXISPRO-KPL500C1	500			
PB-AXISPRO-KPL550C1	550			
PB-AXISPRO-KPL600C1	600			



## AXIS PRO

Sada pro velmi vysokou zásuvku D  
Sada pre veľmi vysokú zásuvku D  
Nagyon magas fiók készlet D  
Set de sertare foarte înalte D

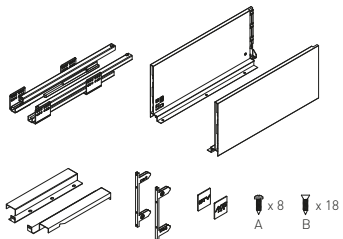







Model	Height (mm)	Color	Material	Material
PB-AXISPRO-KPL250D	250	40	antracitová antracitová antracit	lak lak lakk lac
PB-AXISPRO-KPL300D	300			
PB-AXISPRO-KPL350D	350			
PB-AXISPRO-KPL400D	400			
PB-AXISPRO-KPL450D	450			
PB-AXISPRO-KPL500D	500			
PB-AXISPRO-KPL550D	550	40	bílám biela fehér alb	ocel ocel ocel oțel
PB-AXISPRO-KPL600D	600			
PB-AXISPRO-KPL250D1	250			
PB-AXISPRO-KPL300D1	300			
PB-AXISPRO-KPL350D1	350			
PB-AXISPRO-KPL400D1	400			
PB-AXISPRO-KPL450D1	450	40	bílám biela fehér alb	ocel ocel ocel oțel
PB-AXISPRO-KPL500D1	500			
PB-AXISPRO-KPL550D1	550			
PB-AXISPRO-KPL600D1	600			

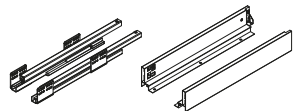

## AXIS PRO

Sada pro velmi nízkou zásuvku  
Sada pre veľmi nízku zásuvku  
Nagyon alacsony fiók készlet  
Set de sertare foarte mici



						
PB-AXISPRO-KPL69-450-60		450	40	antracitová antracitová antracit antracit	lak lak lak lac	ocel ocel ocel oțel
PB-AXISPRO-KPL69-500-60		500				
PB-AXISPRO-KPL69-450-10		450				
PB-AXISPRO-KPL69-500-10		500				







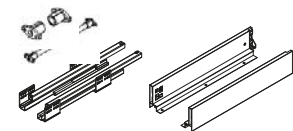

## AXIS PRO PUSH TO OPEN

Sada pro nízkou zásuvku A  
Sada pre nízku zásuvku A  
Alacsony fiók készlet A  
Set de sertare mici A

NEW



						
PB-AXISPRO-P20-KPL250A		250	40	antracitová antracitová antracit antracit	lak lak lak lac	ocel ocel ocel oțel
PB-AXISPRO-P20-KPL300A		300				
PB-AXISPRO-P20-KPL350A		350				
PB-AXISPRO-P20-KPL400A		400				
PB-AXISPRO-P20-KPL450A		450				
PB-AXISPRO-P20-KPL500A		500				
PB-AXISPRO-P20-KPL550A		550				
PB-AXISPRO-P20-KPL600A		600				
PB-AXISPRO-P20-KPL250A1		250				
PB-AXISPRO-P20-KPL300A1		300				
PB-AXISPRO-P20-KPL350A1		350	bílám biela fehér alb	-	-	
PB-AXISPRO-P20-KPL400A1		400				
PB-AXISPRO-P20-KPL450A1		450				
PB-AXISPRO-P20-KPL500A1		500				
PB-AXISPRO-P20-KPL550A1		550				
PB-AXISPRO-P20-KPL600A1		600				
PB-AXISPRO-P20-KPL500A1		500				
PB-AXISPRO-P20-KPL550A1		550				
PB-AXISPRO-P20-KPL600A1		600				
PB-AXISPRO-P20-KPL600A1		600				
PB-AXISPRO-SYNCHRO-P20		1100	-	-	-	-
PB-AXISPRO-SYNCHRO-P20-MOC		-	-	-	-	-



## AXIS PRO PUSH TO OPEN

Sada pro střední zásuvku B  
Sada pre srednǔ zásuvku B  
Közepes fiók készlet B  
Set de sertare medii B

NEW

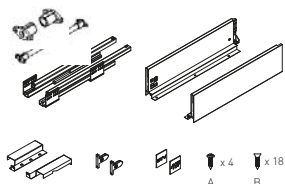

PB-AXISPRO-P20-KPL250B	250	40	antracitová antracitová antracit antracit	lak lak lak lac	ocel ocel ocel ocel								
PB-AXISPRO-P20-KPL300B	300												
PB-AXISPRO-P20-KPL350B	350												
PB-AXISPRO-P20-KPL400B	400												
PB-AXISPRO-P20-KPL450B	450												
PB-AXISPRO-P20-KPL500B	500												
PB-AXISPRO-P20-KPL550B	550												
PB-AXISPRO-P20-KPL600B	600												
PB-AXISPRO-P20-KPL250B1	250												
PB-AXISPRO-P20-KPL300B1	300												
PB-AXISPRO-P20-KPL350B1	350												
PB-AXISPRO-P20-KPL400B1	400												
PB-AXISPRO-P20-KPL450B1	450												
PB-AXISPRO-P20-KPL500B1	500												
PB-AXISPRO-P20-KPL550B1	550												
PB-AXISPRO-P20-KPL600B1	600												
PB-AXISPRO-SYNCHRO-P20	1100							-	-	-	-	-	-
PB-AXISPRO-SYNCHRO-P20-MOC	-							-	-	-	-	-	-



## AXIS PRO PUSH TO OPEN

Sada pro vysokou zásuvku C  
Sada pre vysokú zásuvku C  
Magas fiók készlet C  
Set de sertare înalte C

NEW

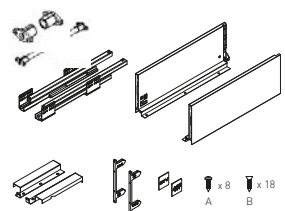

PB-AXISPRO-P20-KPL250C	250	40	antracitová antracitová antracit antracit	lak lak lak lac	ocel ocel ocel ocel								
PB-AXISPRO-P20-KPL300C	300												
PB-AXISPRO-P20-KPL350C	350												
PB-AXISPRO-P20-KPL400C	400												
PB-AXISPRO-P20-KPL450C	450												
PB-AXISPRO-P20-KPL500C	500												
PB-AXISPRO-P20-KPL550C	550												
PB-AXISPRO-P20-KPL600C	600												
PB-AXISPRO-P20-KPL250C1	250												
PB-AXISPRO-P20-KPL300C1	300												
PB-AXISPRO-P20-KPL350C1	350												
PB-AXISPRO-P20-KPL400C1	400												
PB-AXISPRO-P20-KPL450C1	450												
PB-AXISPRO-P20-KPL500C1	500												
PB-AXISPRO-P20-KPL550C1	550												
PB-AXISPRO-P20-KPL600C1	600												
PB-AXISPRO-SYNCHRO-P20	1100							-	-	-	-	-	-
PB-AXISPRO-SYNCHRO-P20-MOC	-							-	-	-	-	-	-





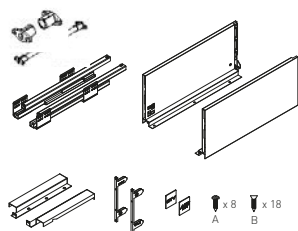

## AXIS PRO PUSH TO OPEN

Sada pro velmi vysokou zásuvku D  
Sada pre veľmi vysokú zásuvku D  
Nágyon magas fiók készlet D  
Set de sertare foarte înalte D

NEW





					
PB-AXISPRO-P20-KPL250D	250	40	-	-	-
PB-AXISPRO-P20-KPL300D	300				
PB-AXISPRO-P20-KPL350D	350				
PB-AXISPRO-P20-KPL400D	400				
PB-AXISPRO-P20-KPL450D	450				
PB-AXISPRO-P20-KPL500D	500				
PB-AXISPRO-P20-KPL550D	550				
PB-AXISPRO-P20-KPL600D	600				
PB-AXISPRO-P20-KPL250D1	250				
PB-AXISPRO-P20-KPL300D1	300				
PB-AXISPRO-P20-KPL350D1	350				
PB-AXISPRO-P20-KPL400D1	400				
PB-AXISPRO-P20-KPL450D1	450				
PB-AXISPRO-P20-KPL500D1	500				
PB-AXISPRO-P20-KPL550D1	550				
PB-AXISPRO-P20-KPL600D1	600				
PB-AXISPRO-SYNCHRO-P20	1100	-	-	-	-
PB-AXISPRO-SYNCHRO-P20-MOC	-	-	-	-	-

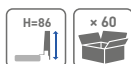
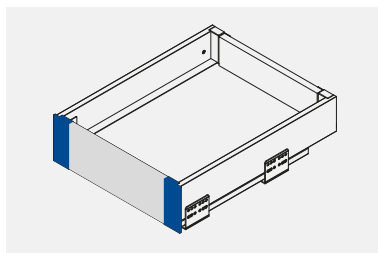

Sada držáků čelního panelu, nízká  
Sada držiakov čelného panelu, nízka  
Belső előlapprőgzítő alacsony  
Conector front pentru sertar interior mic



			
PB-AXISPRO-WEWMOCA		antracitová antracitová antracit antracit	ocel ocel ocel oțel
PB-AXISPRO-WEWMOCA1		bílám biela fehér alb	

Sada držáků čelního panelu, střední  
 Sada držiakov čelného panelu, stredná  
 Belső előlaprögzítő közepes  
 Conector front pentru sertar interior mediu

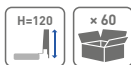
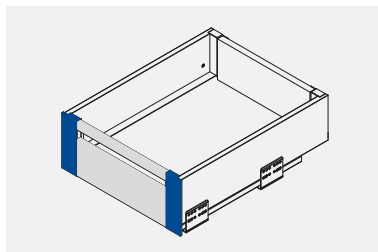

PB-AXISPRO-WEWMOCB		antracitová antracitová antracit	ocel ocel ocel
PB-AXISPRO-WEWMOCB1		bílám biela fehér alb	

Sada držáků čelního panelu, vysoká  
 Sada držiakov čelného panelu, vysoká  
 Belső előlaprögzítő magas  
 Conector front pentru sertar interior inalt

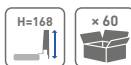
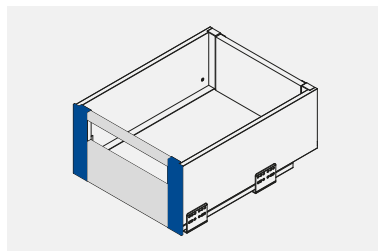

PB-AXISPRO-WEWMOCB		antracitová antracitová antracit	ocel ocel ocel
PB-AXISPRO-WEWMOCB1		bílám biela fehér alb	

Sada držáků čelního panelu, nejvyšší  
 Sada držiakov čelného panelu, najvyššia  
 Belső előlaprögzítő nagyon magas  
 Conector front pentru sertar interior înalt

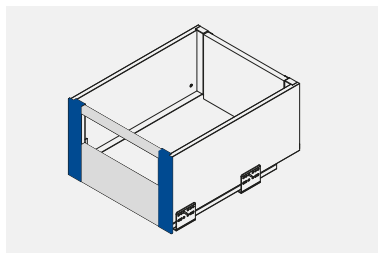

PB-AXISPRO-WEWMOCD		antracitová antracitová antracit	ocel ocel ocel
PB-AXISPRO-WEWMOCD1		bílám biela fehér alb	



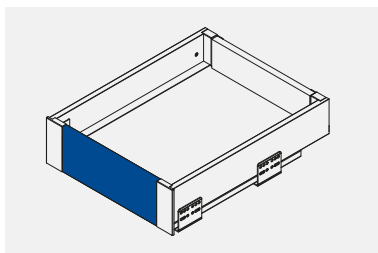

Sada pro nízkou vnitřní zásuvku  
 Sada pre nízkú vnútornú zásuvku  
 Belső fiók készlet alacsony  
 Set sertar interior mic

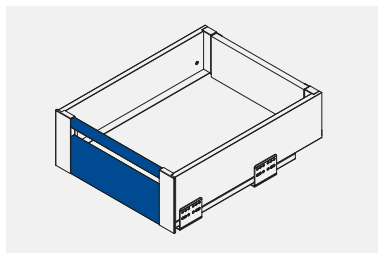

PB-AXISPRO-ZESWEW-A AXISPRO		110	1200	antracitová antracitová antracit	ocel ocel ocel
PB-AXISPRO-ZESWEW-A1 AXISPRO				bílám biela fehér alb	





Sada pro střední vnitřní zásuvku  
 Sada pre strednú vnútornú zásuvku  
 Belső fiók készlet közepes  
 Set sertar interior mediu

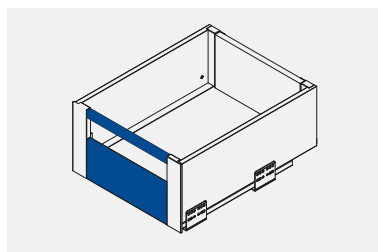

	 H mm	 L mm		
PB-AXISPRO-ZESWEW-B AXISPRO	95	1200	antracitová antracitová antracit	ocel ocel ocel
PB-AXISPRO-ZESWEW-B1 AXISPRO			bílám biela fehér alb	

Sada pro vysokou vnitřní zásuvku  
 Sada pre vysokú vnútornú zásuvku  
 Belső fiók készlet magas  
 Set sertar interior înalt



	 H mm	 L mm		
PB-AXISPRO-ZESWEW-C AXISPRO	110	1200	antracitová antracitová antracit	ocel ocel ocel
PB-AXISPRO-ZESWEW-C1 AXISPRO			bílám biela fehér alb	



Sada pro nejvyšší vnitřní zásuvku  
Sada pre najvyššiu vnútornú zásuvku  
Belső fiók készlet nagyon magas  
Set sertar interior foarte înalt

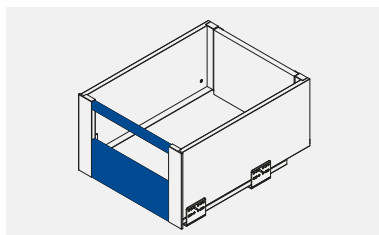
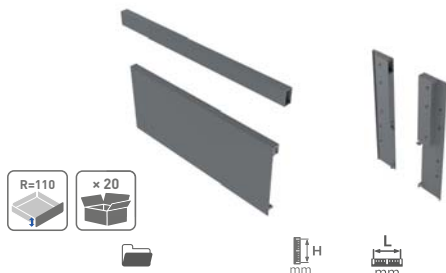

PB-AXISPRO-ZESWEW-D AXISPRO	110	1200	antracitová / antracitová / antracit / antracit	ocel ocel acél oțel
PB-AXISPRO-ZESWEW-D1 AXISPRO			bílá / biela / fehé / alb	

Hranatý podélný reling  
Hranatý pozdĺžny reling  
Szögletes hosszirányú korlát  
Lonjeron longitudinál pártat

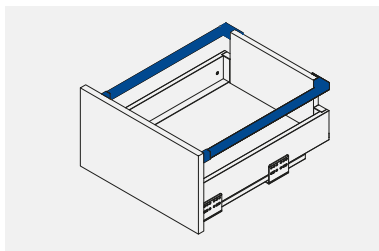

PB-AXISPRO-RELKW300	300	antracitová antracitová antracit antracit	ocel ocel acél oțel	PB-AXISPRO-RELKW300-10	300	bílám biela fehé alb	ocel ocel acél oțel
PB-AXISPRO-RELKW350	350			PB-AXISPRO-RELKW350-10	350		
PB-AXISPRO-RELKW400	400			PB-AXISPRO-RELKW400-10	400		
PB-AXISPRO-RELKW450	450			PB-AXISPRO-RELKW450-10	450		
PB-AXISPRO-RELKW500	500			PB-AXISPRO-RELKW500-10	500		
PB-AXISPRO-RELKW550	550			PB-AXISPRO-RELKW550-10	550		

Označení pro montáž čel AxisPro  
Označenie pre montáž čiel AxisPro  
AxisPro frontok felerősítési jelölője  
Marker pentru montarea fronturilor AxisPro



PB-AXISPRO-ZNACZ-FRONT	plast plast műanyag plastic
------------------------	--------------------------------------

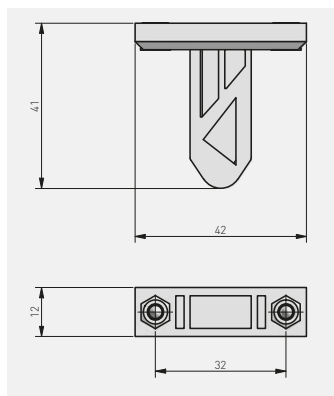

## Modern Box PRO

Sada  
Sada  
Készlet  
Set

### PODÉLNÝ RELING

antracitová / bílá  
L = 300-550 mm

### POZDĚLNÝ RELING

antracitová / bílá  
L = 300-550 mm

### SZÖGLETES HOSSZIRÁNYÚ KORLÁT

antracit / fehér  
L = 300-550 mm

### LONJERON LONGITUDINAL PÁTRAT

antracit / alb  
L = 300-550 mm

### Sada držáků zad MB

Sada držákův zadnej steny MB

A hátlap csatlakozó

Conector panoul posterior

PŘEDNÍ SPOJOVACÍ DÍL + ŠROUBY  
Držiak čela + skrutky  
ELŰLSŐ CSATLAKOZÓ + CSAVAROK  
CONNECTOR FRONT + ŞURUBURI

KRYTKA OTVORU  
antracitová / bílá  
KRYCÍ UZÁVER  
antracitový / biely  
TAKARÓ SAPKA  
antracit / fehér  
CAPAC  
antracit / alb

VÝSUV  
L = 300-550 mm

VÝSUV  
L = 300-550 mm

CSÚSZÓ SÍN  
L = 300-550 mm

GLISIERA  
L = 300-550 mm

### ZAJIŠŤOVACÍ MECHANIZMUS ZÁSUVKY

antracitová / bílá  
L = 300-550 mm

### ZAIŠTÓVACÍ MECHANIZMUS ZÁSUVKY

antracitová / bílá  
L = 300-550 mm

### FIÓK ZÁRÓ MECHANIZMUSA

antracit / fehér  
L = 300-550 mm

### MECANISM DE BLOCARE A SERTARELOR







antracit / alb  
L = 300-550 mm

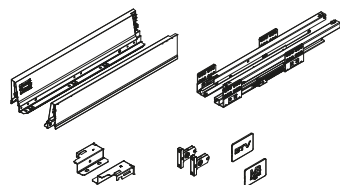

## Modern Box PRO

Sada pro nízkou zásuvku A  
Sada pre nízkú zásuvku A  
Alacsony fiók készlet A  
Set de sertare mici A







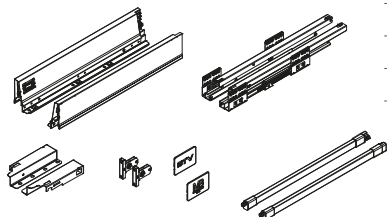

									
PB-MBPRO-KPL300A	300	40	antracitová antracitová antracit antracit	lak lak lak lac	ocel ocel ocel ořetel				
PB-MBPRO-KPL350A	350								
PB-MBPRO-KPL400A	400								
PB-MBPRO-KPL450A	450								
PB-MBPRO-KPL500A	500								
PB-MBPRO-KPL550A	550								
PB-MBPRO-KPL300A1	300					bílám biela fehér alb			
PB-MBPRO-KPL350A1	350								
PB-MBPRO-KPL400A1	400								
PB-MBPRO-KPL450A1	450								
PB-MBPRO-KPL500A1	500								
PB-MBPRO-KPL550A1	550								

## Modern Box PRO

Sada pro střední zásuvku B  
Sada pre strednú zásuvku B  
Közepes fiók készlet B  
Set de sertare medii B







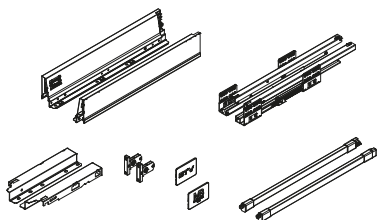

									
PB-MBPRO-KPL300B	300	40	antracitová antracitová antracit antracit	lak lak lak lac	ocel ocel ocel ořetel				
PB-MBPRO-KPL350B	350								
PB-MBPRO-KPL400B	400								
PB-MBPRO-KPL450B	450								
PB-MBPRO-KPL500B	500								
PB-MBPRO-KPL550B	550								
PB-MBPRO-KPL300B1	300					bílám biela fehér alb			
PB-MBPRO-KPL350B1	350								
PB-MBPRO-KPL400B1	400								
PB-MBPRO-KPL450B1	450								
PB-MBPRO-KPL500B1	500								
PB-MBPRO-KPL550B1	550								

## Modern Box PRO

Sada pro vysokou zásuvku C  
Sada pre vysokú zásuvku C  
Magas fiók készlet C  
Set de sertare înalte C



										
PB-MBPRO-KPL300C	300	40		antracitová antracitová antracit antracit	lak lak lakk lac	ocel ocel acél oțel				
PB-MBPRO-KPL350C	350									
PB-MBPRO-KPL400C	400									
PB-MBPRO-KPL450C	450									
PB-MBPRO-KPL500C	500									
PB-MBPRO-KPL550C	550									
PB-MBPRO-KPL300C1	300						bílám biela fehér alb			
PB-MBPRO-KPL350C1	350									
PB-MBPRO-KPL400C1	400									
PB-MBPRO-KPL450C1	450									
PB-MBPRO-KPL500C1	500									
PB-MBPRO-KPL550C1	550									

\*Možnosť „D“ - 167

\*Možnosť „D“ - 167



\*„D“ alternativa- 167



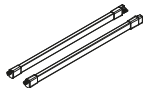

\*Opțiunea „D” – 167



Související produkty  
Súvisiace produkty  
Kapcsolódó termékek  
Produse asociate





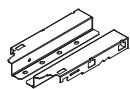

			
PB-MBPRO-KPL300A	PB-MBPRO-KPL300A1	300	antracitová antracitová antracit antracit
PB-MBPRO-KPL350A	PB-MBPRO-KPL350A1	350	
PB-MBPRO-KPL400A	PB-MBPRO-KPL400A1	400	
PB-MBPRO-KPL450A	PB-MBPRO-KPL450A1	450	
PB-MBPRO-KPL500A	PB-MBPRO-KPL500A1	500	
PB-MBPRO-KPL550A	PB-MBPRO-KPL550A1	550	
PB-MBPRO-RELKW300	PB-MBPRO-RELKW300-10	300	bílám biela fehér alb
PB-MBPRO-RELKW350	PB-MBPRO-RELKW350-10	350	
PB-MBPRO-RELKW400	PB-MBPRO-RELKW400-10	400	
PB-MBPRO-RELKW450	PB-MBPRO-RELKW450-10	450	
PB-MBPRO-RELKW500	PB-MBPRO-RELKW500-10	500	
PB-MBPRO-RELKW550	PB-MBPRO-RELKW550-10	550	

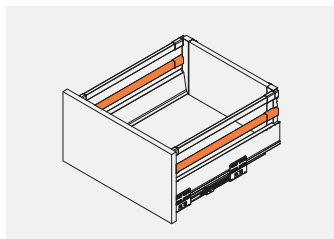

					
PB-MBPRO-ZLATYLD	D		antracitová antracitová antracit antracit	lak lak lakk lac	ocel ocel acél oțel
PB-MBPRO-ZLATYLD1					



Podelný hranatý reling  
 Pozdĺžny reling  
 Hosszirányú kortlát  
 Lonjeron longitudinal



		 L mm	
PB-MBPRO-RELKW300		300	antracitová antracitová antracit antracit
PB-MBPRO-RELKW350		350	
PB-MBPRO-RELKW400		400	
PB-MBPRO-RELKW450		450	
PB-MBPRO-RELKW500		500	
PB-MBPRO-RELKW550		550	

		 L mm	
PB-MBPRO-RELKW300-10		300	biélám biela fehér alb
PB-MBPRO-RELKW350-10		350	
PB-MBPRO-RELKW400-10		400	
PB-MBPRO-RELKW450-10		450	
PB-MBPRO-RELKW500-10		500	
PB-MBPRO-RELKW550-10		550	



Sada držáků čelního panelu, nízká  
 Sada držiakov čelného panelu, nízka  
 Belső előlaprögzítő alacsony  
 Conector front pentru sertar interior mic

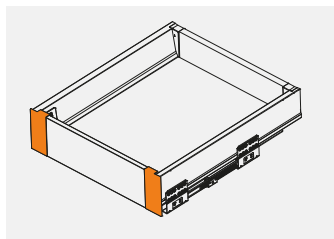

				
PB-MBPRO-WEWMOCA		nízká zásuvka A nízka zásuvka A alacsony fiók A sertar mic A	antracitová / antracitová / antracit / antracit	plast plast műanyag plastic
PB-MBPRO-WEWMOCA1			bilá / biela / fehéř / alb	

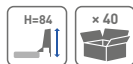

Sada držáků čelního panelu, střední  
 Sada držiakov čelného panelu, stredná  
 Belső előlaprögzitő közepes  
 Conector front pentru sertar interior mediu

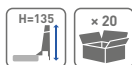
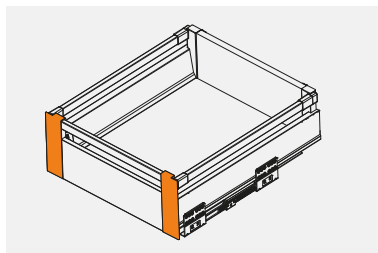

			
PB-MBPRO-WEWMOCB		antracitová / antracitová / antracit / antracit	ocel ocel acél oțel
PB-MBPRO-WEWMOCB1		bílá / biela / fehéř / alb	

Sada držáků čelního panelu, vysoká  
 Sada držiakov čelného panelu, vysoká  
 Belső előlaprögzitő magas  
 Conector front pentru sertar interior inalt

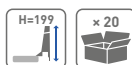
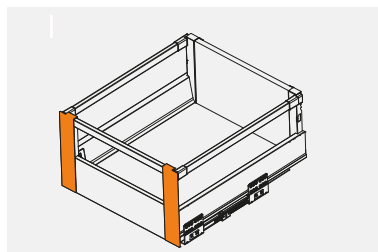

			
PB-MBPRO-WEWMOCC		antracitová / antracitová / antracit / antracit	ocel ocel acél oțel
PB-MBPRO-WEWMOCC1		bílá / biela / fehéř / alb	

Držák čelního panelu 167 „D”  
 Držiak predného panelu 167 „D”  
 Front csatlakozó 167 „D”  
 Conector de front 167 „D”

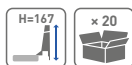
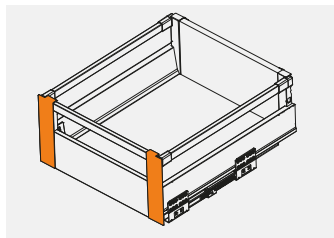

			
PB-MBPRO-WEWMOCD	antracitová / antracitová / antracit / antracit	ocel ocel acél oțel	
PB-MBPRO-WEWMOCD1	bílá / biela / fehér / alb		

Sada držáků zad MB nízká  
 Sada držiakov zadnej steny MB, nízka  
 A hátlap csatlakozó alacsony  
 Conector panoul posterior, mic

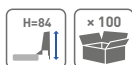
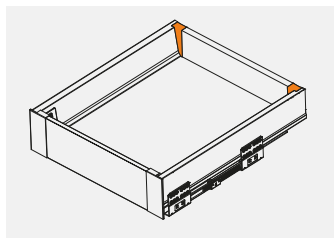

			
PB-MBPRO-ZLATYLA	antracitová / antracitová / antracit / antracit	ocel ocel acél oțel	
PB-MBPRO-ZLATYLA1	bílá / biela / fehér / alb		

Sada držáků zad MB střední  
 Sada držiakov zadnej steny MB, stredná  
 Hátlap csatlakozó, közepes  
 Conector panou posterior, mediu

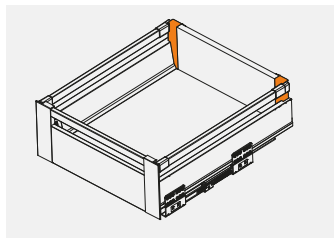

		
PB-MBPRO-ZLATYLB	antracitová / antracitová / antracit / antracit	ocel ocel acél oțel
PB-MBPRO-ZLATYLB1	bilá / biela / fehér / alb	

Sada držáků zad MB vysoká  
 Sada držiakov zadnej steny, vysoká  
 Hátlap csatlakozó, magas  
 Conector panoul posterior, înalt

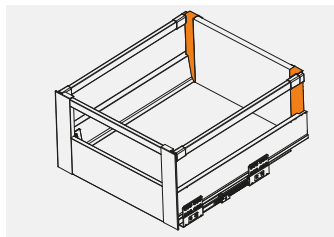

		
PB-MBPRO-ZLATYLC	antracitová / antracitová / antracit / antracit	ocel ocel acél oțel
PB-MBPRO-ZLATYLC1	bilá / biela / fehér / alb	



Sada držáků zad MB vysoká  
 Sada držiakov zadnej steny, vysoká  
 Hátlap csatlakozó, magas  
 Conector panoul posterior, înalt

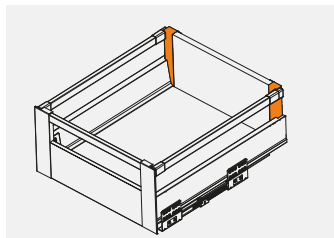

			
PB-MBPRO-ZLATYLD		antracitová / antracitová / antracit / antracit	ocel ocel acél oțel
PB-MBPRO-ZLATYLD1		bílá / biela / fehéř / alb	

Držák zad zvýšeného zadního panelu  
 Držiak zad zvýšeného zadného panelu  
 Hátlap korlát csatlakozó, kiegészítı  
 Conector suplimentar lonjeroane cu panou posterior

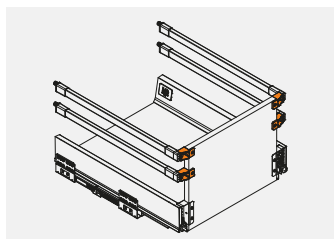

			
PB-MBPRO-MOCRELYL		antracitová / antracitová / antracit / antracit	ocel ocel acél oțel
PB-MBPRO-MOCRELYL1		bílá / biela / fehéř / alb	

Sada pro organizaci vnitřní zásuvky H=84  
 Sada pre organizáciu vnútornej zásuvky H=84  
 Fiokrendező készlet belső fiokrendszerhez H=84  
 Organizator pentru sertar interior H=84

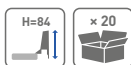
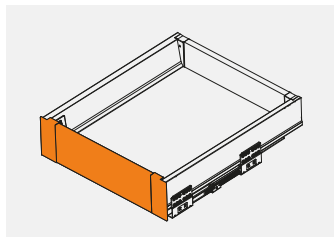

		
PB-MBPRO-ZESWEW-A	antracitová / antracitová / antracit / antracit	plast plast műanyag plastic
PB-MBPRO-ZESWEW-A1	bílá / biela / fehér / alb	

Sada pro organizaci vnitřní zásuvky H=135  
 Sada pre organizáciu vnútornej zásuvky H=135  
 Fiokrendező készlet belső fiokrendszerhez H=135  
 Organizator pentru sertar interior H=135

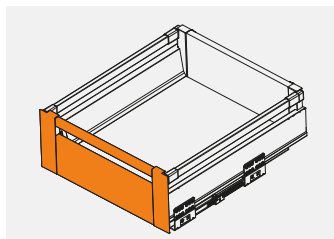

		
PB-MBPRO-ZESWEW-B	antracitová / antracitová / antracit / antracit	plast plast műanyag plastic
PB-MBPRO-ZESWEW-B1	bílá / biela / fehér / alb	

Sada pro organizaci vnitřní zásuvky H=199  
 Sada pre organizáciu vnútornej zásuvky H=199  
 Fiokrendező készlet belső fiokrendszerhez H=199  
 Organizator pentru sertar interior H=199

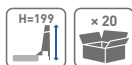
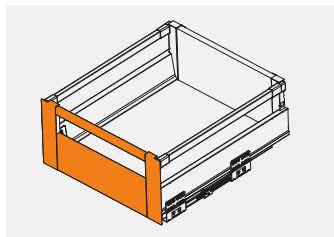

		
PB-MBPRO-ZESWEW-C	antracitová / antracitová / antracit / antracit	plast plast műanyag plastic
PB-MBPRO-ZESWEW-C1	bílá / biela / fehér / alb	

Sada pro organizaci vnitřní zásuvky H=167  
 Sada pre organizáciu vnútornej zásuvky H=167  
 Fiokrendező készlet belső fiokrendszerhez H=167  
 Organizator pentru sertar interior H=167

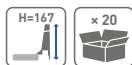
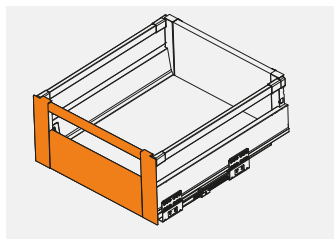

		
PB-MBPRO-ZESWEW-D	antracitová / antracitová / antracit / antracit	plast plast műanyag plastic
PB-MBPRO-ZESWEW-D1	bílá / biela / fehér / alb	

## Modern Box Square

Sada  
Sada  
Készlet  
Set

### SPOJOVACÍ DÍL ZADNÍHO PANELU

nizký / strední / vysoký  
šedá / bílá

### DRŽIAK ZADNÉHO PANELU

nizký / strední / vysoký

šedá / bílá

### HÁTSÓ PANEL CSATLAKOZÓ

alacsony / középmagas / magas

szürke / fehér

### CONECTOR PANOU SPATE

inferior / mediu / inalt

gri / alb

### PŘEDNÍ SPOJOVACÍ DÍL + ŠROUBY

Držiak čela + skrutky

ELÜLSŐ CSATLAKOZÓ + CSAVAROK

CONECTOR FRONT + ȘURUBURI

### KRYTKA OTVORU

šedá / bílá

### KRYCÍ UZÁVER

šedá / bílá

### TAKARÓ SÁPKA ANTRACIT / FEHÉR

szürke / fehér

DAPAC gri / alb

### PODÉLNÝ RELING

šedá / bílá

L = 250-550 mm

### POZDĹŽNÝ RELING

šedá / bílá

L = 250-550 mm

### SZŐGLETES HOSSZIRÁNYÓ KORLÁT

szürke / fehér

L = 250-550 mm

### LONJERON LONGITUDINAL PÁTRAT

gri / alb

L = 250-550 mm

### STRANA ZÁSUVKY

šedá / bílá

L = 250-550 mm

### BOČNICA

šedá / bílá

L = 250-550 mm

### OLDALA

szürke / fehér

L = 250-550 mm

### SERTARULUI

gri / alb

L = 250-550 mm

### VÝŠUV

L = 250-550 mm

### VÝŠUV

L = 250-550 mm

### CSÚSZÓ SÍN

L = 250-550 mm

### GLISIERA

L = 250-550 mm



## Modern Box Square

Sada pro nízkou zásuvku A  
Sada pre nízku zásuvku A  
Alacsony fiók készlet A  
Set de sertare mici A

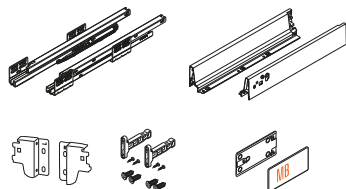

	L mm	kg ↓				
PB-KW-KPL250A	250		40	šedá sivá szürke gri	lak lak lakk lac	ocel ocel acél oțel
PB-KW-KPL300A	300					
PB-KW-KPL350A	350					
PB-KW-KPL400A	400					
PB-KW-KPL450A	450					
PB-KW-KPL500A	500					
PB-KW-KPL550A	550		40	bílám biela fehér alb	lak lak lakk lac	ocel ocel acél oțel
PB-KW-KPL600A	600					
PB-KW-KPL250A1	250					
PB-KW-KPL300A1	300					
PB-KW-KPL350A1	350					
PB-KW-KPL400A1	400					
PB-KW-KPL450A1	450					
PB-KW-KPL500A1	500					
PB-KW-KPL550A1	550					
PB-KW-KPL600A1	600					

## Modern Box Square

Sada pro střední zásuvku B  
Sada pre srednú zásuvku B  
Közepes fiók készlet B  
Set de sertare medii B

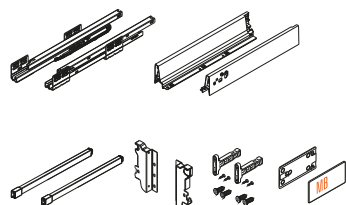

	L mm	kg ↓				
PB-KW-KPL250B	250		40	šedá sivá szürke gri	lak lak lakk lac	ocel ocel acél oțel
PB-KW-KPL300B	300					
PB-KW-KPL350B	350					
PB-KW-KPL400B	400					
PB-KW-KPL450B	450					
PB-KW-KPL500B	500					
PB-KW-KPL550B	550		40	bílám biela fehér alb	lak lak lakk lac	ocel ocel acél oțel
PB-KW-KPL600B	600					
PB-KW-KPL250B1	250					
PB-KW-KPL300B1	300					
PB-KW-KPL350B1	350					
PB-KW-KPL400B1	400					
PB-KW-KPL450B1	450					
PB-KW-KPL500B1	500					
PB-KW-KPL550B1	550					
PB-KW-KPL600B1	600					

## Modern Box Square





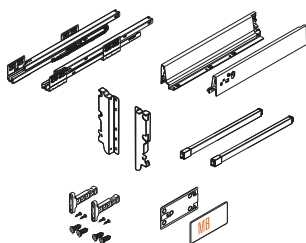

Sada pro vysokou zásuvku C

Sada pre vysokú zásuvku C

Magas fiók készlet C

Set de sertare inalte C



						
PB-KW-KPL250C		250				
PB-KW-KPL300C		300				
PB-KW-KPL350C		350				
PB-KW-KPL400C		400				
PB-KW-KPL450C		450				
PB-KW-KPL500C		500				
PB-KW-KPL550C		550				
PB-KW-KPL600C		600				
PB-KW-KPL250C1		250				
PB-KW-KPL300C1		300				
PB-KW-KPL350C1		350				
PB-KW-KPL400C1		400				
PB-KW-KPL450C1		450				
PB-KW-KPL500C1		500				
PB-KW-KPL550C1		550				
PB-KW-KPL600C1		600				









## Podelný hranatý reling

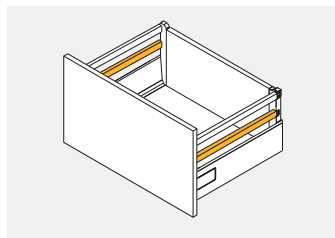



Pozdĺžny reling

Hosszirányú korlát

Lonjeron longitudinal



					
PB-D-RELKW350		350			
PB-D-RELKW400		400			
PB-D-RELKW450		450			
PB-D-RELKW500		500			
PB-D-RELKW550		550			

					
PB-D-RELKW350-10		350			
PB-D-RELKW400-10		400			
PB-D-RELKW450-10		450			
PB-D-RELKW500-10		500			
PB-D-RELKW550-10		550			



Sada držáků čelního panelu, nízká  
Sada držiakov čelného panelu, nízka  
Belső előlaprögzitő alacsony  
Conector front pentru sertar interior mic

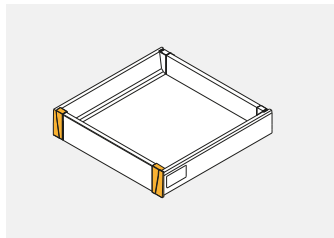

PB-D-WEWMOCA-KW	nízká zásuvka A nízka zásuvka A alacsony fiók A sertar mic A	šedá / sivá / szürke / gri	plast plast műanyag plastic
PB-D-WEWMOCA-KW-10		bílá / biela / fehér / alb	



Sada držáků čelního panelu, střední  
Sada držiakov čelného panelu, stredná  
Belső előlaprögzitő közepes  
Conector front pentru sertar interior mediu

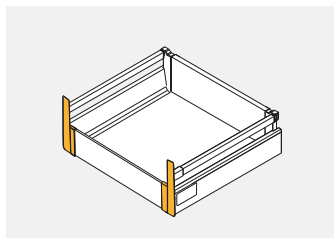





PB-D-WEWMOCB-KW	střední zásuvka B stredná zásuvka B közepes B fiók sertar mediu B	šedá / sivá / szürke / gri	plast plast műanyag plastic
PB-D-WEWMOCB-KW-10		bílá / biela / fehér / alb	

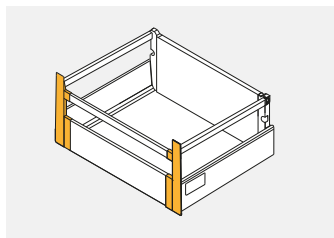

Sada držáků čelního panelu, vysoká  
 Sada držiakov čelného panelu, vysoká  
 Belső előlaprögzítő magas  
 Conector front pentru sertar inalt



			
PB-D-WEWMOCC-KW	vysoká zásuvka C vysoká zásuvka C magas fiók C sertar înalt C	šedá / sivá / szürke / gri	plast plast műanyag plastic
PB-D-WEWMOCC-KW-10		bilá / biela / fehéř / alb	



Sada pro vysokou vnitřní zásuvku Modern Box Square  
 Sada pre vysokú vnútornú zásuvku Modern Box Square  
 Szett a Modern Box Square magas belső fiókjához  
 Set pentru sertar interior Modern Box Square

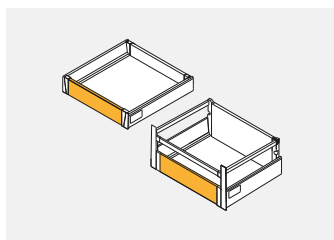

			
PB-D-ZESWEWKW-C	1100 mm	šedá / sivá / szürke / gri	hliník, hliník, aluminium, aluminium
PB-D-ZESWEWKW-C-10		bilá / biela / fehéř / alb	





Sada pro organizaci vnitřní zásuvky Modern Box Square  
 Sada pre organizáciu vnútornej zásuvky Modern Box Square  
 Fiokrendező készlet a Modern Box Square számára  
 Organizator pentru sertar interior Modern Box Square

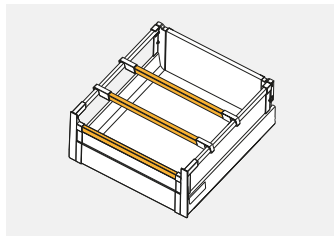





			
PB-D-WEWORGKW-A	1100	šedá / sivá / szürke / gri	ocel ocel acél oțel
PB-D-WEWORGKW-A-10		bílá / biela / fehér / alb	

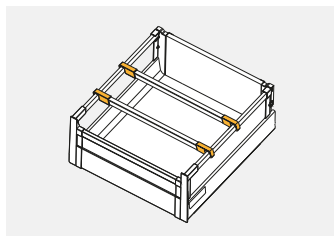

Držák příčného relingu  
 Držiak priečného relingu  
 Keresztirányú korlát csatlakozó  
 Conector lonjeron transversal



			
PB-D-ZR-KW-00	1 sada = 2 ks 1 súprava = 2 ks 1 készlet = 2 db 1 set = 2 buc	šedá / sivá / szürke / gri	plast plast műanyag plastic
PB-D-ZR-KW-10		bílá / biela / fehér / alb	



Sada pro organizaci vnitřní zásuvky  
 Sada pre organizáciu vnútornej zásuvky  
 Fiokrendező készlet belső fiokrendszerhez  
 Organizator pentru sertar interior

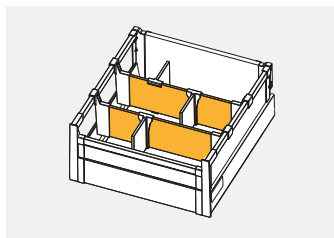

	 mm		
PB-D-WEWORGKW-B	1100	šedá / sivá / szürke / gri	hliník, hliník, aluminium, aluminium
PB-D-WEWORGKW-B-10		bílá / biela / fehér / alb	



Držák vnitřního předělu zásuvky  
 Držiak vnútorného predelenia zásuvky  
 Keresztirányú oszlop csatlakozó  
 Conector bara transversala

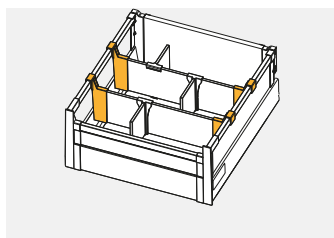



			
PB-D-CONREL-KW	1 sada = 2 ks 1 súprava = 2 ks 1 készlet = 2 db 1 set = 2 buc	šedá / sivá / szürke / gri	plast plast műanyag plastic
PB-D-CONREL-KW-10		bílá / biela / fehér / alb	

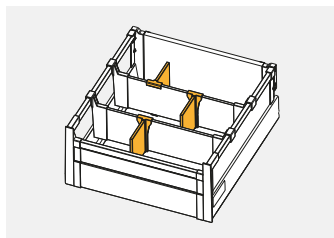

Přepážka pro vnitřní členění  
 Prepážka pre vnútorné členenie  
 Keresztirányú oszlopelválasztó  
 Separator bara transversala





			
PB-D-PRZEGLP-KW	1 ks 1 ks	šedá / sivá / szürke / gri	plast plast műanyag
PB-D-PRZEGLP-KW-10	1 db 1 buc	bílá / biela / fehér / alb	plastic

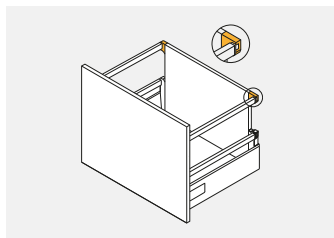

Držák zad zvýšeného zadního panelu  
 Držiak zad zvýšeného zadného panelu  
 Hátlap korlát csatlakozó, kiegészítő  
 Conector suplimentar lonjeroane cu panou posterior







			
PB-D-D2R0-00	1 sada = 2 ks 1 súprava = 2 ks 1 készlet = 2 db	šedá / sivá / szürke / gri	plast plast műanyag
PB-D-D2R0-01	1 set = 2 buc	bílá / biela / fehér / alb	plastic

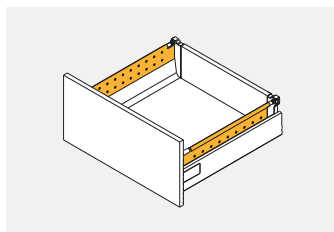
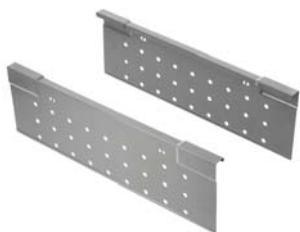

Perforovaná strana  
 Perforaná strana  
 Perforált oldal  
 Lateral perforată







			
PB-D-BXSIDEKW25C	250	šedá sivá szürke gri	ocel ocel acél oțel
PB-D-BXSIDEKW30C	300		
PB-D-BXSIDEKW35C	350		
PB-D-BXSIDEKW40C	400		
PB-D-BXSIDEKW45C	450		
PB-D-BXSIDEKW50C	500		
PB-D-BXSIDEKW55C	550		
PB-D-BXSIDEKW25C-10	250	bílám biela fehér alb	
PB-D-BXSIDEKW30C-10	300		
PB-D-BXSIDEKW35C-10	350		
PB-D-BXSIDEKW40C-10	400		
PB-D-BXSIDEKW45C-10	450		
PB-D-BXSIDEKW50C-10	500		
PB-D-BXSIDEKW55C-10	550		

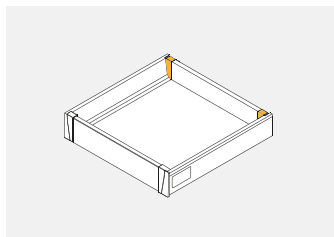

Sada držáků zad MB nízká  
Sada držiakov zadnej steny MB, nízka  
A hátlap csatlakozó alacsony  
Conector panoul posterior, mic







			
PB-D-N2R0-00	1 sada = L + P 1 súprava = L+P 1 készlet = L + R 1 set = L + R	šedá / sivá / szürke / gri	ocel ocel acél oțel
PB-D-N2R0-01		bílá / biela / fehér / alb	

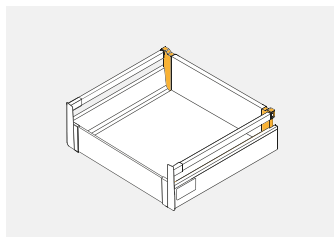

Sada držáků zad MB střední  
Sada držiakov zadnej steny MB, stredná  
Hátlap csatlakozó, közepes  
Conector panoul posterior, mediu



			
PB-D-S2R0-00	1 sada = L + P 1 súprava = L+P 1 készlet = L + R 1 set = L + R	šedá / sivá / szürke / gri	ocel ocel acél oțel
PB-D-S2R0-01		bílá / biela / fehér / alb	



Sada držáků zad MB vysoká  
Sada držiakov zadnej steny, vysoká  
Hátlap csatlakozó, magas  
Conector panoul posterior, înalt

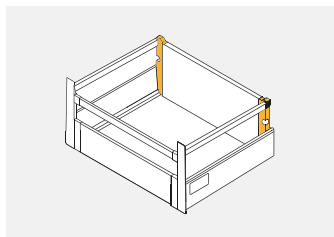

PB-D-W2R0-00	1 sada = L + P 1 súprava = L+P 1 készlet = L + R 1 set = L + R	šedá / sivá / szürke / gri	ocel ocel acél oțel
PB-D-W2R0-01		bílá / biela / fehéř / alb	



Držák relingu  
Držiak relingu  
Korlát csatlakozó  
Conector Lonjeroane



PB-D-MHG04-KW	1 ks 1 ks 1 db 1 buc	šedá sivá szürke gri	plast plast műanyag plastic
---------------	-------------------------------	-------------------------------	--------------------------------------



Šablona pro relingy  
 Šablona pre relingy  
 Korlát jelölőszablon  
 Matricea pentru lonjeroane



			
PB-D-MATRYCA	1 sada = 2 ks 1 súprava = 2 ks 1 készlet = 2 db 1 set = 2 buc	šedá sivá szürke gri	plast plast műanyag plastic



Šablona pro čelní kování  
 Šablona pre čelné kovanie  
 Jelölőszablon, fiokelolaphoz  
 Matricea pentru front sertar



			
PB-D-ZNACZ-0	1 sada = 2 ks 1 súprava = 2 ks 1 készlet = 2 db 1 set = 2 buc	šedá sivá szürke gri	ZnAl



## Modern Box

Sada  
Sada  
Készlet  
Set

SPOJOVACÍ DÍL ZADNÍHO PANELU  
nízký / střední / vysoký  
šedá / bílá

DRŽIAK ZADNÉHO PANELU  
nízký / střední / vysoký  
sivá / biela

HÁTSÓ PANEEL CSATLAKOZÓ  
alacsony / középmagas / magas  
szürke / fehér

CONNECTOR PANOU SPATE  
inferior / mediu / inalt  
gri / alb

PODÉLNÝ RELING  
šedá / bílá  
L = 250-550 mm

POZDĚLNÝ RELING  
sivá / biela  
L = 250-550 mm

SZÖGLETES HOSSZIRÁNYÚ KORLÁT  
szürke / fehér  
L = 250-550 mm

LONJERON LONGITUDINÁL PÁTRAT  
gri / alb  
L = 250-550 mm

VÝSUV

L = 250-550 mm

VÝSUV

L = 250-550 mm

CSÚSZÓ SÍN

L = 250-550 mm

GLISIERA

L = 250-550 mm

STRANA ZÁSUVKY

šedá / bílá

L = 250-550 mm

BOČNICA

sivá / biela

L = 250-550 mm

OLDALA

szürke / fehér

L = 250-550 mm

SERTARULUI

gri / alb

L = 250-550 mm

PŘEDNÍ SPOJOVACÍ DÍL + ŠROUBY

Držiak čela + skrutky

ELÜLSŐ CSATLAKOZÓ + CSAVAROK

CONNECTOR FRONT + ŞURUBURI

KRYTKA OTVORU

šedá / bílá

KRYCÍ UZÁVER

sivá / biela

TAKARÓ SAPKA

szürke / fehér

DAPAC gri / alb





## Modern Box





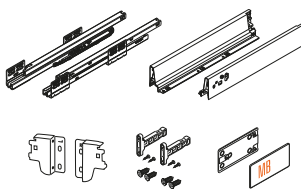

Sada pro nízkou zásuvku A

Sada pre nízkú zásuvku A

Alacsony fiók készlet A

Set de sertare mici A



		 L mm		 kg			
PB-D-KPL250A	250	soft close	40	šedá sivá szürke grí	lak lak lac	ocel ocel ocel	
PB-D-KPL300A	300						
PB-D-KPL350A	350						
PB-D-KPL400A	400						
PB-D-KPL450A	450						
PB-D-KPL500A	500						
PB-D-KPL550A	550						
PB-D-KPL250A1	250						
PB-D-KPL300A1	300						
PB-D-KPL350A1	350						
PB-D-KPL400A1	400						
PB-D-KPL450A1	450						
PB-D-KPL500A1	500						
PB-D-KPL550A1	550						
PB-D-P20250A	250						push to open
PB-D-P20300A	300						
PB-D-P20350A	350						
PB-D-P20400A	400						
PB-D-P20450A	450						
PB-D-P20500A	500						



## Modern Box

Sada pro střední zásuvku B  
Sada pre strednú zásuvku B  
Közepes fiók készlet B  
Set de sertare medii B

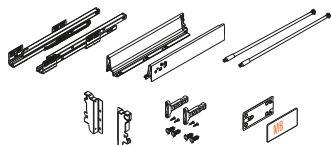

PB-D-KPL250B	250	soft close	40	šedá sivá szürke gri	lak lak lakk lac	ocel ocel acél otél
PB-D-KPL300B	300					
PB-D-KPL350B	350					
PB-D-KPL400B	400					
PB-D-KPL450B	450					
PB-D-KPL500B	500					
PB-D-KPL550B	550					
PB-D-KPL250B1	250			bílám biela fehér alb		
PB-D-KPL300B1	300					
PB-D-KPL350B1	350					
PB-D-KPL400B1	400					
PB-D-KPL450B1	450					
PB-D-KPL500B1	500					
PB-D-KPL550B1	550					



## Modern Box

Sada pro vysokou zásuvku C  
Sada pre vysokú zásuvku C  
Magas fiók készlet C  
Set de sertare inalte C

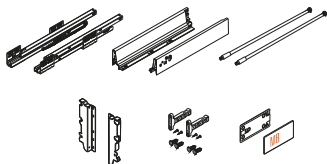







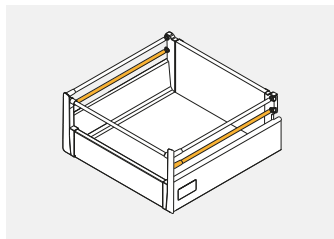





PB-D-KPL250C	250	soft close	40	šedá sivá szürke gri	lak lak lakk lac	ocel ocel acél otél
PB-D-KPL300C	300					
PB-D-KPL350C	350					
PB-D-KPL400C	400					
PB-D-KPL450C	450					
PB-D-KPL500C	500					
PB-D-KPL550C	550					
PB-D-KPL250C1	250			bílám biela fehér alb		
PB-D-KPL300C1	300					
PB-D-KPL350C1	350					
PB-D-KPL400C1	400					
PB-D-KPL450C1	450					
PB-D-KPL500C1	500					
PB-D-KPL550C1	550					
PB-D-P20300C	300	push to open		šedá sivá szürke gri		
PB-D-P20350C	350					
PB-D-P20400C	400					
PB-D-P20450C	450					
PB-D-P20500C	500					
PB-D-P20550C	550					



Podelný hranatý reling  
 Pozdĺžny reling  
 Hosszirányú kortlát  
 Lonjeron longitudinal







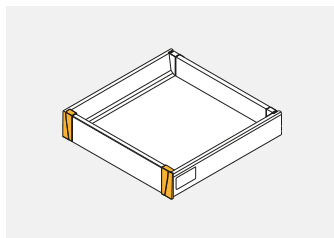

	 mm		
PB-D-REL2500	250		
PB-D-REL3000	300		
PB-D-REL3500	350		
PB-D-REL4000	400		
PB-D-REL4500	450		
PB-D-REL5000	500		
PB-D-REL5500	550	šedá sivá szürke gri	ocel ocel ocel oțel

	 mm		
PB-D-REL450-10	450		
PB-D-REL500-10	500		
PB-D-REL550-10	550		
		bílám biela fehér alb	ocel ocel ocel oțel



Sada držáků čelního panelu, nízká  
 Sada držiakov čelného panelu, nízka  
 Belső előlapprógzító alacsony  
 Conector front pentru sertar interior mic







			
PB-D-WEWMOCA	nízká zásuvka A nízka zásuvka A alacsony fiók A sertar mic A		
PB-D-WEWMOCA1			
		bílá / biela / fehér / alb	plast plast műanyag plastic

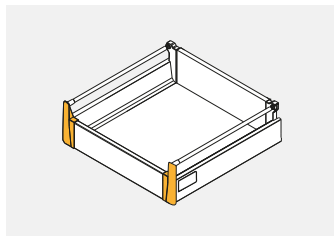

Sada držáků čelního panelu, střední  
Sada držiakov čelného panelu, stredná  
Belső előlaprögzitő közepes  
Conector front pentru sertar interior mediu







			
PB-D-WEWMOCB	střední zásuvka B stredná zásuvka B közepes B fiók sertar mediu B	šedá / sivá / szürke / gri	plast plast műanyag plastic
PB-D-WEWMOCB1		bílá / biela / fehé / alb	

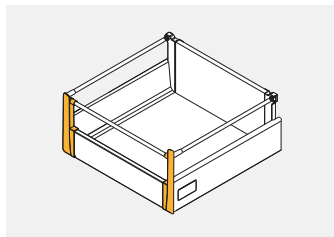

Sada držáků čelního panelu s 1 relingem  
Sada držiakov čelného panelu s 1 relingom  
Belső fiók csatlakozó magas, 1 korlát szetthez  
Conector sertar interior inalt, pentru 1 set de lonjeroane







			
PB-D-WEWSZKLC	vysoká zásuvka C, 1 reling vysoká zásuvka C, 1 výsuv magas fiók C, 1 sín sertar înalt C, 1 șină	šedá / sivá / szürke / gri	plast plast műanyag plastic
PB-D-WEWSZKLC-10		bílá / biela / fehé / alb	

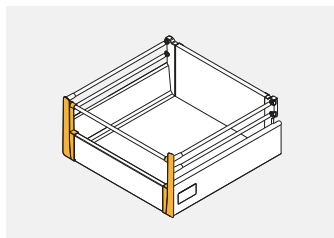

Sada držáků čelního panelu pro 2 relingy  
 Sada držiakov čelného panelu pre 2 relingy  
 Belső fiók előlap rögzítő, magas, 2 korlát szetthez  
 Conector sertar interior, înalt, pentru 2 seturi de lonjeroane



			
PB-D-WEWMOCC	vysoká zásuvka C, 2 reling vysoká zásuvka C, 2 výsuvy magas fiók C, 2 sín sertar înalt C, 2 șine	šedá / sivá / szürke / gri	plast
PB-D-WEWMOCC1		bílá / biela / fehér / alb	plast müanyag plastic



Sada pro vysokou vnitřní zásuvku  
 Sada pre vysokú vnútornú zásuvku  
 Belső fiók készlet magas  
 Set sertar interior înalt

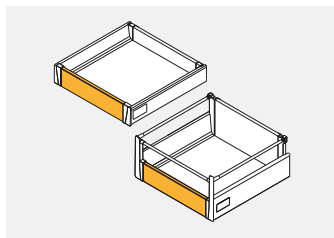

	 mm		
PB-D-ZESWEW-C	1100	šedá / sivá / szürke / gri	hliník, hliník, aluminium, aluminium
PB-D-ZESWEW-C-10		bílá / biela / fehér / alb	



Sada pro organizaci vnitřní zásuvky  
 Sada pre organizáciu vnútrnej zásuvky  
 Fiokrendező készlet belső fiokrendszerhez  
 Organizator pentru sertar interior

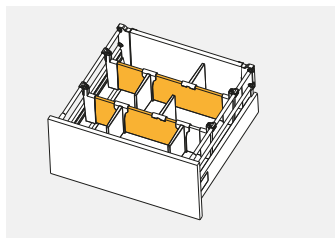

PB-D-WEWORG-A	1100	šedá / sivá / szürke / gri	hliník, hliník, aluminium, aluminu
PB-D-WEWORG-A-10		bílá / biela / fehér / alb	
PB-D-WEWORG-B		šedá / sivá / szürke / gri	
PB-D-WEWORG-B-10		bílá / biela / fehér / alb	



Držák příčného relingu  
 Držiak priečného relingu  
 Keresztirányú korlát csatlakozó  
 Conector lonjeron transversal

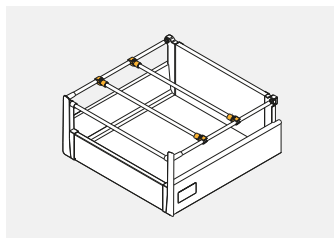

			
PB-D-ZR-00-0	1 sada = 2 ks 1 súprava = 2 ks 1 készlet = 2 db 1 set = 2 buc	šedá / sivá / szürke / gri	plast plast műanyag plastic
PB-D-ZR-00-10		bílá / biela / fehér / alb	



Úchyt pro vnitřní zásuvku  
 Držiak pre vnútornú zásuvku  
 Belső fiók fogantyú  
 Mâner sedrtar intern

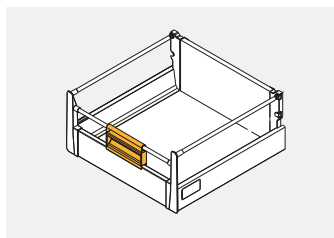

		
PB-D-UCHWEW	šedá / sivá / szürke / gri	plast plast műanyag plastic
PB-D-UCHWEW-10	bílá / biela / fehér / alb	



Křížová spojka relingů  
 Křížová spojka relingov  
 Keresztirányú korlát csatlakozó  
 Conector șină transversală

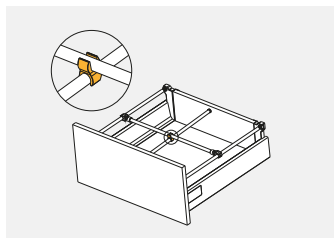

		
PB-D-LR-00-0	šedá / sivá / szürke / gri	plast plast műanyag plastic
PB-D-LR-00-10	bílá / biela / fehér / alb	



Záslepka vnitřního relingu  
 Záslepka vnútorného relingu  
 Végzáró a keresztirányú korláthoz  
 Capăt pentru lonjeron transversal

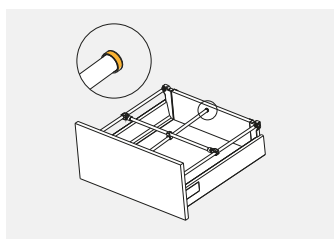





		
PB-D-RELCOV	šedá / sivá / szürke / gri	plast plast műanyag plastic
PB-D-RELCOV-10	bílá / biela / fehér / alb	



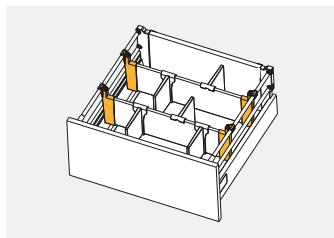

Držák vnitřního příčného dělení  
 Držiak vnútorného priečneho delenia  
 Csatlakozó a keresztirányú korláthoz és rúdhoz  
 Conector pentru lonjeron si bara transversală







			
PB-D-CONREL	1 sada = 2 ks 1 súprava = 2 ks 1 készlet = 2 db 1 set = 2 buc	šedá / sivá / szürke / gri	plast plast műanyag plastic
PB-D-CONREL-10		bílá / biela / fehér / alb	

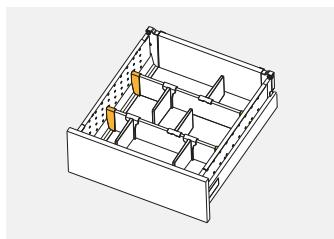

Koncovka příčného dělení pro perforovanou bočnici  
 Koncovka priečneho delenia pre perforovanú bočnicu  
 Keresztirányú rúd csatlakozó perforált oldalakhoz  
 Conector transversal pentru bare cu laterale perforate



			
PB-D-CONBXSID	1 sada = 2 ks 1 súprava = 2 ks 1 készlet = 2 db 1 set = 2 buc	šedá / sivá / szürke / gri	plast plast műanyag plastic
PB-D-CONBXSIDE-10		bílá / biela / fehér / alb	



Přepážka příčného předělu  
 Prepážka priečneho predelenia  
 Keresztirányú oszlopelválasztó  
 Separator bara transversala

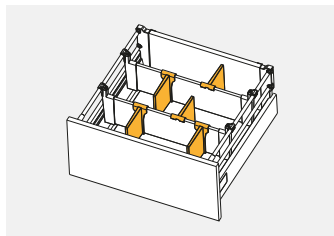

PB-D-PRZEGLP	šedá / sivá / szürke / gri	plast plast műanyag plastic
PB-D-PRZEGLP-10	bílá / biela / fehé / alb	



Perforovaná boční strana k střední zásuvce  
 Perforaná bočná strana k strednej zásuvke  
 Perforált oldal közepes fiókhhoz  
 Laterale perforate pentru sertar mediu

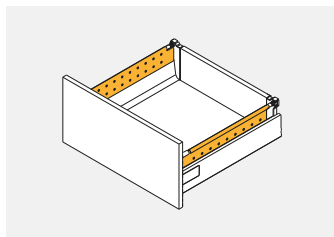





PB-D-BXSIDE45B	450	šedá / sivá / szürke / gri	ocel ocel acél oțel
PB-D-BXSIDE45B-10		bílá / biela / fehé / alb	
PB-D-BXSIDE50B	500	šedá / sivá / szürke / gri	
PB-D-BXSIDE50B-10		bílá / biela / fehé / alb	

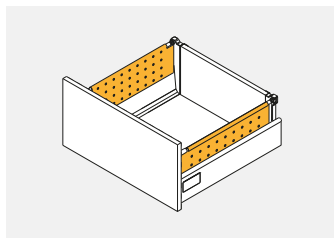

Perforovaná boční strana k vysoké zásuvce  
 Perforovaná bočná strana k vysokej zásuvke  
 Perforált oldal a magas fiókhhoz  
 Laterale perforate pentru sertar înalt







	 L mm		
PB-D-BXSIDE45C	450	šedá / sivá / szürke / gri	ocel ocel acél oțel
PB-D-BXSIDE45C-10		bílá / biela / fehér / alb	
PB-D-BXSIDE50C	500	šedá / sivá / szürke / gri	
PB-D-BXSIDE50C-10		bílá / biela / fehér / alb	

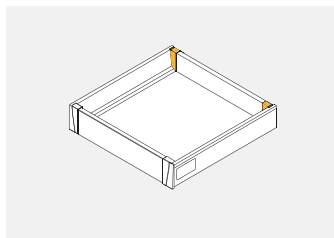

Spojka zadní stěny nízká MB  
 Spojka zadnej steny nízka MB  
 A hátlap csatlakozó alacsony  
 Conector panoul posterior, mic







			
PB-D-N2R0-00	1 sada = L + P 1 súprava = L + P 1 készlet = L + R 1 set = L + R	šedá / sivá / szürke / gri	ocel ocel acél oțel
PB-D-N2R0-01		bílá / biela / fehér / alb	

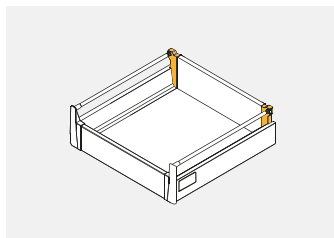

Spojka zadní stěny střední  
 Spojka zadnej steny, stredná  
 Hátlap csatlakozó, közepes  
 Conector panou posterior, mediu







			
PB-D-S2R0-00	1 sada = L + P 1 súpava = L+P 1 kszlet = L + R 1 set = L + R	šedá / sivá / szürke / gri	ocel ocel acél oțel
PB-D-S2R0-01		bílá / biela / fehér / alb	

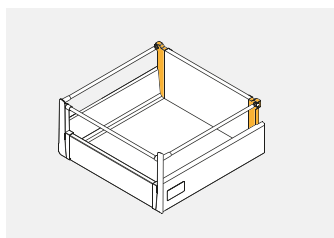

Spojka zadní stěny vysoká  
 Spojka zadnej steny vysoká  
 Hátlap csatlakozó, magas  
 Conector panoul posterior, înalt



			
PB-D-W2R0-00	1 sada = L + P 1 súpava = L+P 1 kszlet = L + R 1 set = L + R	šedá / sivá / szürke / gri	ocel ocel acél oțel
PB-D-W2R0-01		bílá / biela / fehér / alb	



Držák relingu pro zvýšená záda  
 Držiak relingu pre vyvýšenú zadnú stenu  
 Hátlap korlát csatlakozó, kiegészítő  
 Conector suplimentar lonjeroane cu panou posterior

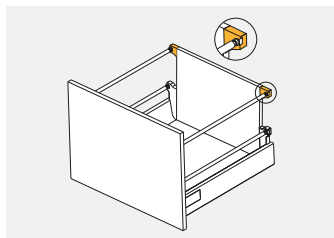





			
PB-D-D2R0-00	1 sada = 2 ks 1 súprava = 2 ks 1 készlet = 2 db 1 set = 2 buc	šedá / sivá / szürke / gri	plast plast műanyag plastic
PB-D-D2R0-01		bílá / biela / fehér / alb	



Šablona pro relingu  
 Šablona pre relingu  
 Korlát jelölőszablon  
 Matricea pentru lonjeroane







			
PB-D-MATRYCA	1 sada = 2 ks 1 súprava = 2 ks 1 készlet = 2 db 1 set = 2 buc	šedá / sivá / szürke / gri	plast plast műanyag plastic



Šablona pro čelní kování  
 Šablona pre čelné kovanie  
 Jelölősablon, fiokelolaphoz  
 Matricea pentru front sertar







			
PB-D-ZNACZ-0	1 sada = 2 ks 1 súprava = 2 ks 1 készlet = 2 db 1 set = 2 buc	šedá, sivá, szürke, gri	ZnAl



Držák relingu MB  
 Držiak relingu  
 Korlát csatlakozó  
 Conector Lonjeroane



			
PB-D-MHG04	1 sada = 2 ks 1 súprava = 2 ks 1 készlet = 2 db 1 set = 2 buc	šedá / sivá / szürke / gri	plast plast műanyag plastic



Stabilizátor zásuvky pro zásuvku typu push to open  
 Stabilizátor zásuvky pre zásuvky typu push to open  
 Fiókstabilizátor Push 2 Open fiókhhoz  
 Stabilizator pentru sertare cu push 2 open

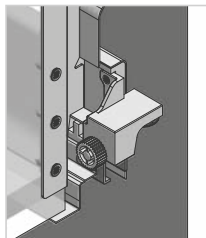

PB-D-MBSTAB-00	1 sada = L + P 1 súprava = L+P 1 készlet = L + R 1 set = L + R	šedá, sivá, szürke, gri	plast plast műanyag plastic



## Modern Box

Sada pro zásuvku pod tróubou, nízká  
 Sada pre zásuvku pod rúrou, nízká  
 Sütü alatti fiórendszer, alacsony  
 Sertar sub cuptor

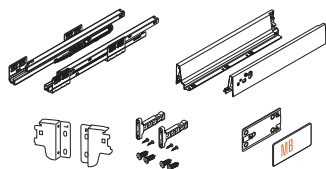

PB-D-KPL68-450-80	450	40	šedá, sivá, szürke, gri	lak lakk lac	ocel ocel acél oțel
PB-D-KPL68-500-80	500				
PB-D-KPL68-450-10	450	40	bílám biela fehér alb	lak lakk lac	ocel ocel acél oțel
PB-D-KPL68-500-10	500				



## Modern Box

Zásuvka pod dřez – sada

Zásuvka pod drez - sada

Mosogató alatti fiokrendszer

Sertar sub chiuvetă

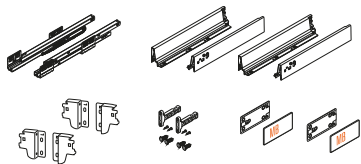

PB-D-ZLE-450	450	40	šedá, sivá, szürke, gri	lak lak lakk lac	ocel ocel acél oțel
PB-D-ZLE-500	500				

## Modern Box

Zásuvka pod dřez U, nízká – sada

Zásuvka pod drez U, nízká - sada

Mosogató alatti „U” fiokrendszer

Sertar sub chiuvetă tip U

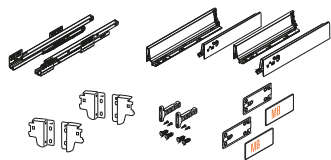

PB-D-ULE-500	500	40	šedá, sivá, szürke, gri	lak lak lakk lac	ocel ocel acél oțel



Šablona pro zásuvky AXIS PRO A MODERNÍ BOX  
 Šablóna pre zásuvky AXIS PRO A MODERN BOX  
 AXIS PRO és MODERN Bokszi fiók sablon  
 Şablon de sertare AXIS PRO ŞI MODERN BOX

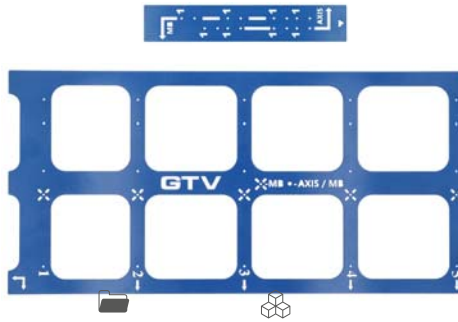

PB-SZABLON-AXIS-MB	ocel océl oţel
--------------------	----------------------

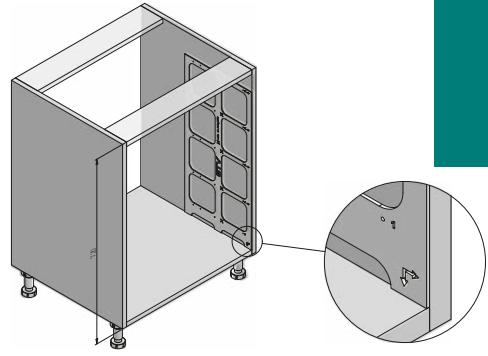

720 mm

\* pouze MB L-250  
 iba MB L-250  
 csak MB L-250  
 numai MB L-250

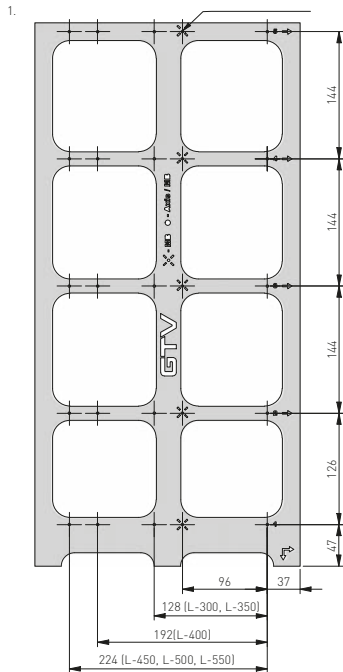

AxisPRO Řada otvorů pro spodní čela  
 AxisPRO Rad otvorov pro dalsie čela  
 AxisPRO Széria furatok az alsó frontokhoz  
 AxisPRO Serie de găuri pentru partea frontală inferioară

AxisPRO Řada otvorů pro další čela  
 AxisPRO Rad otvorov pre ďalšie čela  
 AxisPRO Széria furatok a fennmaradó frontokhoz  
 AxisPRO Serie de găuri pentru restatele pentrui frontale

2.

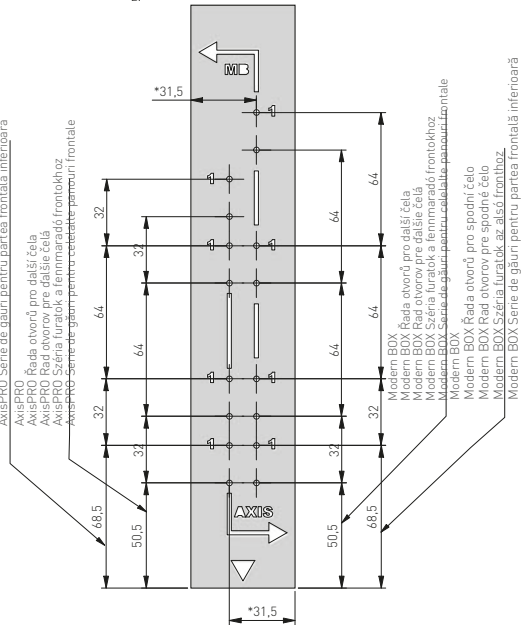

1. Šablona pro AxisPro a MB (standardní zásuvka H=720)  
 Šablóna pre AxisPro a MB (standardná zásuvka H=720)  
 Sablon az AxisPro és az MB sorozathoz (standard fiók H=720)  
 Şablon pentru AxisPro şi MB (sertar standard H=720)

2. Šablona pro čela H=140 a H=284 (MB, AxisPro) Univerzální  
 Šablóna pre čela H=140 a H=284 (MB, AxisPro) Univerzálna  
 Front sablon H=140 és H=284 (MB, AxisPro) Univerzális  
 Şablon pentru partea frontală H=140 şi H=284 (MB, AxisPro) Universal

\* NF - nasazeni čela na bok 16  
 NF - nasadenie čela na bok 16  
 NF - front felhelyezése a 16 oldalra  
 NF - suprapunere faţă pe lateral 16

Šablona pro zásuvky AXIS PRO A MODERNÍ BOX PRO  
 Šablóna pre zásuvky AXIS PRO A MODERNÍ BOX PRO  
 AXIS PRO és MODERN BOKSZ PRO fiók sablon  
 Șablon de sertare AXIS PRO și MODERN BOX PRO

NEW

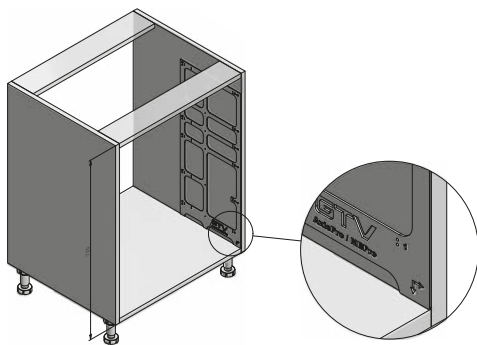
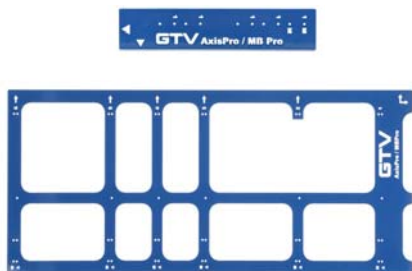

PB-SZABLON-AXIS-MBPRO

ocel  
ocel  
ocel



720 mm

\* NF - nasazeni čela na bok 16  
 NF - nasazeni čela na bok 16  
 NF - front felhelyezése a 16 oldalra  
 NF - suprapunere față pe lateral 16

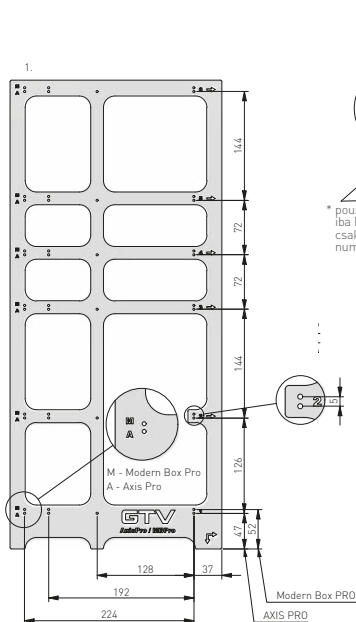

\* pouze MB L-250  
 iba MB L-250  
 csak MB L-250  
 numai MB L-250

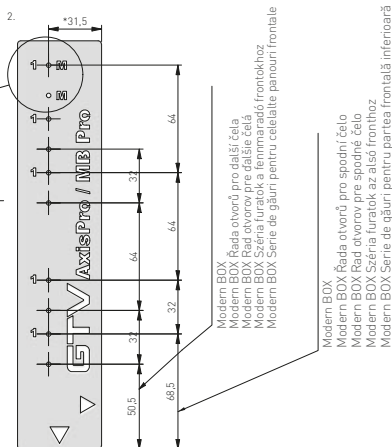

1. Šablona pro AxisPro a MB [standardní zásuvka H=720]  
 Šablóna pre AxisPro a MB [standardná zásuvka H=720]  
 Sablon az AxisPro és az MB sorozathoz [standard fiók H=720]  
 Șablon pentru AxisPro și MB [sertar standard H=720]
2. Šablona pro čela H=140 a H=284 [MB, AxisPro] Univerzální  
 Šablóna pre čelá H=140 a H=284 [MB, AxisPro] Univerzálna  
 Front sablon H=140 és H=284 [MB, AxisPro] Univerzális  
 Șablon pentru partea frontală H=140 și H=284 [MB, AxisPro] Universal



MB

Vložka CUSTOMI A nastavitelná  
 Vložka CUSTOMI A nastavitelná  
 Állítható evőeszköz-szervező CUSTOMI A  
 Organizator de tacâmuri reglabil CUSTOMI A

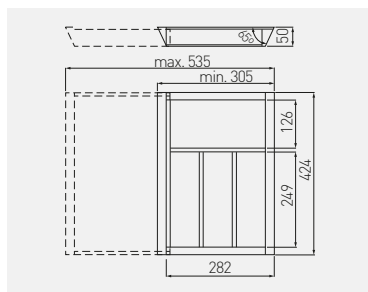

Pro Modern Box nebo Axis PRO L = 450 mm  
 Pre Modern Box alebo Axis PRO L = 450 mm  
 Modern Box vagy Axis PRO esetén L = 450 mm  
 Pentru ModernBox sau Axis PRO L = 450 mm

Maximální výšuv = 535 mm  
 Maximálny výšuv = 535 mm  
 Maximális meghosszabbítás = 535 mm  
 Extensie maximă = 535 mm

				
W-CUSTOMI-60L450	424 x 305	čirý matný povrch čirý matný povrch átlátszó bevonat matt felület suprafajță transparentă mată	buk buk bükfka fag	bukové dřevo bukové drevo bükfka lemn de fag



Vložka CUSTOMI BIS A nastavitelná  
 Vložka CUSTOMI BIS A nastavitelná  
 Állítható evőeszköz-szervező CUSTOMI BIS A  
 Organizator de tacâmuri reglabil CUSTOMI BIS A

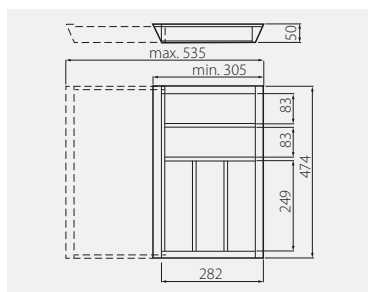

Pro Modern Box nebo Axis PRO L = 500 mm  
 Pre Modern Box alebo Axis PRO L = 500 mm  
 Modern Box vagy Axis PRO esetén L = 500 mm  
 Pentru ModernBox sau Axis PRO L = 500 mm

Maximální výšuv = 535 mm  
 Maximálny výšuv = 535 mm  
 Maximális meghosszabbítás = 535 mm  
 Extensie maximă = 535 mm

				
W-CUSTOMI-60L500	474 x 305	čirý matný povrch čirý matný povrch átlátszó bevonat matt felület suprafajță transparentă mată	buk buk bükfka fag	bukové dřevo bukové drevo bükfka lemn de fag



Vložka CUSTOMI B nastavitelná  
 Vložka CUSTOMI B nastavitelná  
 Állítható evőeszköz-szervező CUSTOMI B  
 Organizator de tacâmuri reglabil CUSTOMI B

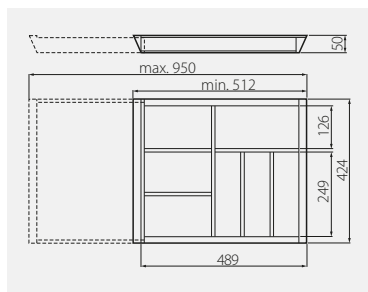

Pro Modern Box nebo Axis PRO L = 450 mm  
 Pre Modern Box alebo Axis PRO L = 450 mm  
 Modern Box vagy Axis PRO esetén L = 450 mm  
 Pentru ModernBox sau Axis PRO L = 450 mm

Maximální výšuv = 950 mm  
 Maximálny výšuv = 950 mm  
 Maximális toldás = 950 mm  
 Extensie maximă = 950 mm

				
W-CUSTOMI-80L450	512 x 424	čirý matný povrch čirý matný povrch átlátszó bevonat matt felület suprafajță transparentă mată	buk buk bükfa fag	bukové dřevo bukové dřevo bükfa lemn de fag



Vložka CUSTOMI BIS B nastavitelná  
 Vložka CUSTOMI BIS B nastavitelná  
 Állítható evőeszköz-szervező CUSTOMI BIS B  
 Organizator de tacâmuri reglabil CUSTOMI BIS B

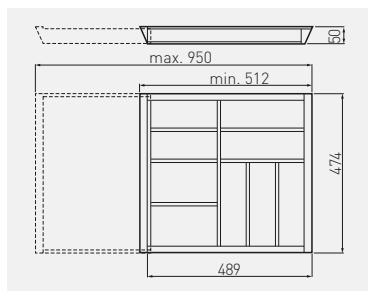

Pro Modern Box nebo Axis PRO L = 500 mm  
 Pre Modern Box alebo Axis PRO L = 500 mm  
 Modern Box vagy Axis PRO esetén L = 500 mm  
 Pentru ModernBox sau Axis PRO L = 500 mm

Maximální výšuv = 950 mm  
 Maximálny výšuv = 950 mm  
 Maximális toldás = 950 mm  
 Extensie maximă = 950 mm





				
W-CUSTOMI-80L500	512 x 474	čirý matný povrch čirý matný povrch átlátszó bevonat matt felület suprafajță transparentă mată	buk buk bükfa fag	bukové dřevo bukové dřevo bükfa lemn de fag

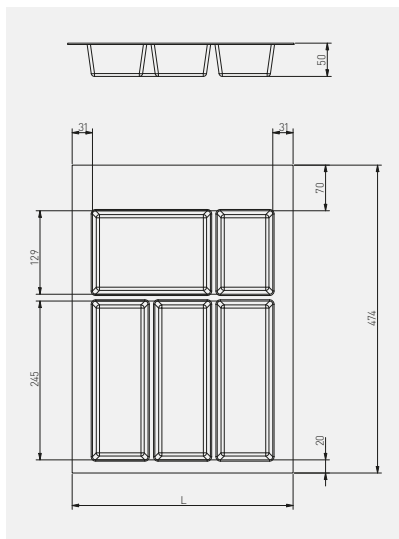

Přiborník Axispace  
 Příborník Axispace  
 Evőeszköz-szervező Axispace  
 Organizator de tacâmuri Axispace

NEW



	 L mm	 mm		
WK-SZ-AS-400-10	282-340	400	bílám biela fehér alb	plast, plast, műanyag, plastic
WK-SZ-AS-500-10	382-440	500		
WK-SZ-AS-600-10	482-540	600		
WK-SZ-AS-800-10	682-740	800	antracitová, antracitová, antracit, antracit	
WK-SZ-AS-900-10	782-840	900		
WK-SZ-AS-400-60	282-340	400		
WK-SZ-AS-500-60	382-440	500		
WK-SZ-AS-600-60	482-540	600		
WK-SZ-AS-800-60	682-740	800		
WK-SZ-AS-900-60	782-840	900		



Protiskluzová podložka do zásuvek AXISPACE  
 Protišmyková podložka do zásuviek AXISPACE  
 Csúszásgátló szőnyeg AXISPACE fiókokhoz  
 Antiderapant pentru sertare AXISPACE

NEW



	 L mm		
MA-MATA-1-10	5000 x 480	bílá / biela / fehér / alb	plast, plast, műanyag, plastic
MA-MATA-1-20		černá / čierna / fekete / negro	
MA-MATA-1-60		antracitová / antracitová / antracit / antracit	



FRIENDLY

Podpěra PELIKAN malá  
Podpera PELIKAN malá  
Polctartó PELIKAN kicsi  
Suport raft PELIKAN mic

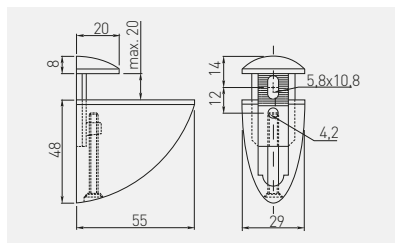

		
PP-MP0055-01	chrom / chróm / króm / crom	ZnAl
PP-MP0055-02	satén / satén / szatén / satin	
PP-MP0055-05	hliník / hliník / alumínium / aluminiu	
PP-MP0055-06	kartáčovaná ocel / kartáčovaná ocel / szálcsiszolt acél / oțel periat	

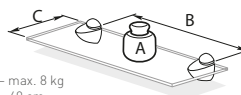

A – max. 8 kg  
B – 40 cm  
C – 20 cm

Maximální zatížení závisí na počtu podpěr a materiálu, ze kterého je police vyrobena.

Maximálne zaťaženie závisí od počtu podpier a materiálu, z ktorého je polica vyrobená.

A maximális terhelés attól függ, hogy a támaszok száma és az anyag milyen anyagból készül.

Sarcina maximă depinde de numărul de suporturi și material din care este realizat raftul.

Policová podpěra PELIKAN, střední  
Policová podpera PELIKAN, stredná  
Polctartó PELIKAN medium  
Suport raft mediu PELIKAN

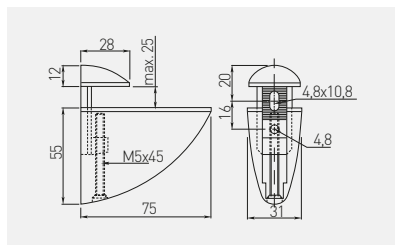

		
PP-SP0075-01	chrom / chróm / króm / crom	ZnAl
PP-SP0075-02	satén / satén / szatén / satin	
PP-SP0075-05	hliník / hliník / alumínium / aluminiu	
PP-SP0075-06	kartáčovaná ocel / kartáčovaná ocel / szálcsiszolt acél / oțel periat	

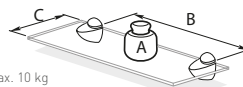

A – max. 10 kg  
B – 50 cm  
C – 25 cm

Maximální zatížení závisí na počtu podpěr a materiálu, ze kterého je police vyrobena.

Maximálne zaťaženie závisí od počtu podpier a materiálu, z ktorého je polica vyrobená.

A maximális terhelés attól függ, hogy a támaszok száma és az anyag milyen anyagból készül.

Sarcina maximă depinde de numărul de suporturi și material din care este realizat raftul.

Policová podpěra PELIKAN, velká  
 Policová podpera PELIKAN, veľká  
 Polctartó PELIKAN nagy  
 Suport raft PELIKAN mare

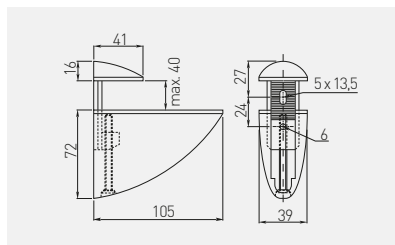

PP-DP0105-01	chrom / chróm / króm / crom	ZnAl
PP-DP0105-02	satén / satén / szatén / satin	
PP-DP0105-05	hliník / hliník / alumínium / aluminiiu	
PP-DP0105-06	kartáčovaná ocel / kartáčovaná ocel / szálcsiszolt acél / oțel periat	

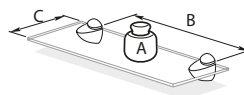

A – max. 12 kg  
 B – 60 cm  
 C – 30 cm

Maximální zatížení závisí na počtu podpěr a materiálu, ze kterého je police vyrobena.

Maximálne zaťaženie závisí od počtu podpier a materiálu, z ktorého je polica vyrobená.

A maximális terhelés attól függ, hogy a támaszok száma és az anyag milyen anyagból készül.

Sarcina maximă depinde de numărul de suporturi și material din care este realizat raftul.

Policové podpěry GS02  
 Policové podpery GS02  
 Polctartó GS02  
 Suport raft GS02

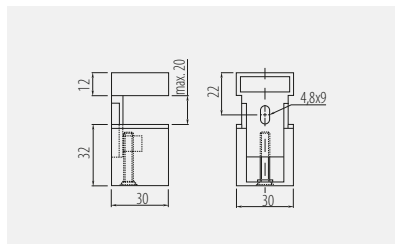

PP-00GS02-01	chrom / chróm / króm / crom	ZnAl
PP-00GS02-02	satén / satén / szatén / satin	
PP-00GS02-05	hliník / hliník / alumínium / aluminiiu	
PP-00GS02-06	kartáčovaná ocel / kartáčovaná ocel / szálcsiszolt acél / oțel periat	

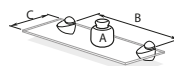

A – max. 4 kg  
 B – 40 cm  
 C – 20 cm

Maximální zatížení závisí na počtu podpěr a materiálu, ze kterého je police vyrobena.

Maximálne zaťaženie závisí od počtu podpier a materiálu, z ktorého je polica vyrobená.

A maximális terhelés attól függ, hogy a támaszok száma és az anyag milyen anyagból készül.

Sarcina maximă depinde de numărul de suporturi și material din care este realizat raftul.



Policové podpěry GS03  
 Policové podpery GS03  
 Polctartó GS03  
 Suport raft GS03

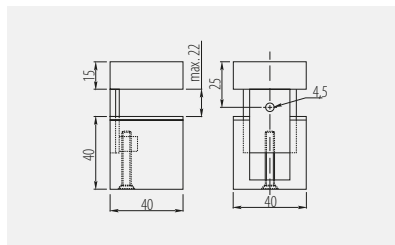

PP-00GS03-01	chrom / chróm / króm / crom	ZnAl
PP-00GS03-02	satén / satén / szatén / satin	
PP-00GS03-05	hliník / hliník / aluminium / aluminiu	
PP-00GS03-06	kartáčovaná ocel / kartáčovaná ocel / szálcsiszolt acél / oțel periat	

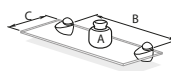

A – max. 6 kg  
 B – 50 cm  
 C – 25 cm

Maximální zatížení závisí na počtu podpěr a materiálu, ze kterého je police vyrobená.

Maximálne zaťaženie závisí od počtu podpier a materiálu, z ktorého je police vyrobená.

A maximális terhelés attól függ, hogy a támaszok száma és az anyag milyen anyagból készül.

Sarcina maximă depinde de numărul de suporturi și material din care este realizat raftul.

Policové podpěry GS04  
 Policové podpery GS04  
 Polctartó GS04  
 Suport raft GS04

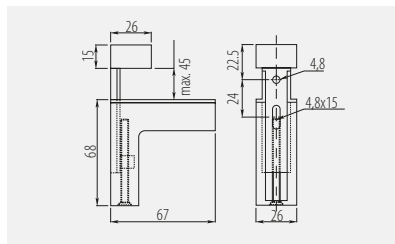

PP-00GS04-01	chrom / chróm / króm / crom	ZnAl
PP-00GS04-02	satén / satén / szatén / satin	
PP-00GS04-05	hliník / hliník / aluminium / aluminiu	
PP-00GS04-06	kartáčovaná ocel / kartáčovaná ocel / szálcsiszolt acél / oțel periat	

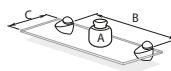

A – max. 10 kg  
 B – 60 cm  
 C – 30 cm

Maximální zatížení závisí na počtu podpěr a materiálu, ze kterého je police vyrobená.

Maximálne zaťaženie závisí od počtu podpier a materiálu, z ktorého je police vyrobená.

A maximális terhelés attól függ, hogy a támaszok száma és az anyag milyen anyagból készül.

Sarcina maximă depinde de numărul de suporturi și material din care este realizat raftul.

Podpěrka A48 - montáž na šroub  
 Podperka A48 - montáž na skrutku  
 Poltartó A48 csavaros  
 Suport raft montat cu şurub A48

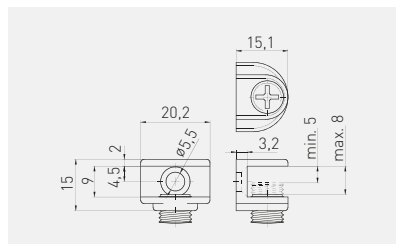

PP-GL-A48-01

chrom / chróm / króm / crom

ZnAl



Podpěra B48  
 Podperka B48  
 Poltartó B48 dugó  
 Suport raft conectat B48

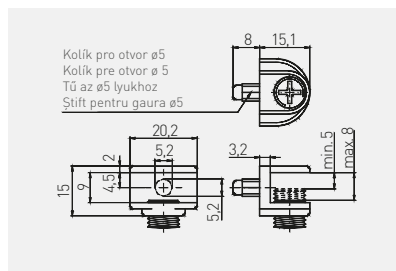

PP-GL-B48-01

chrom / chróm / króm / crom

ZnAl



Podpěrka CGP  
 Podperka CGP  
 Poltartó CGP csavaros  
 Suport raft CGP șurub montat

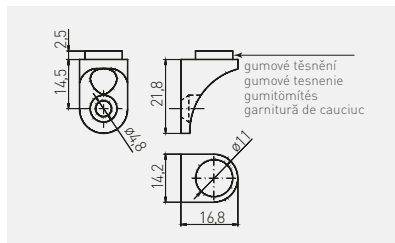

		
PP-GL-CGP-01	chrom / chróm / króm / crom	ZnAl



Podpěrka E410  
 Podperka E410  
 Poltartó E410 dugó  
 Suport raft conectat E410

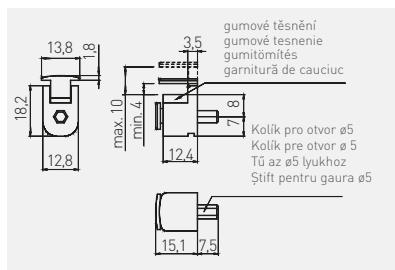

		
PP-GL-E410-01	chrom / chróm / króm / crom	ZnAl





Policová podpěrka SL3  
 Policová podperka SL3  
 Poltartó SL3  
 Suport raft SL3

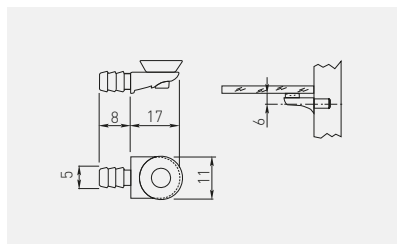

PP-SOL003-01T



chrom / chróm / króm / crom



ZnAl + plast / ZnAl + plast / ZnAl + műanyag / ZnAl + plastic



Policová podpěrka SL12  
 Policová podperka SL12  
 Polctartó SL12  
 Suport raft SL12

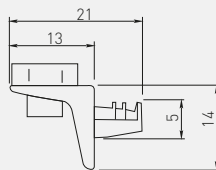

Tloušťka skla max. 5 mm  
 Hrúbka skla max. 5 mm  
 Üvegvastagság max. 5 mm  
 Grosime sticlă max. 5 mm



PP-S0L012-01T



chrom / chróm / króm / crom



ZnAl + plast / ZnAl + plast / ZnAl + műanyag / ZnAl + plastic



Policová podpěrka HS0  
 Policová podperka HS0  
 Polctartó HS0  
 Suport raft HS0

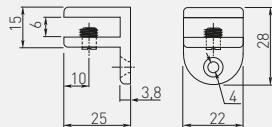

Tloušťka skla max. 5 mm  
 Hrúbka skla max. 5 mm  
 Üvegvastagság max. 5 mm  
 Grosime sticlă max. 5 mm



PP-HS0006-01



chrom / chróm / króm / crom



ZnAl



Policová podpěrka HS2  
 Policová podperka HS2  
 Poltartó HS2  
 Suport raft HS2

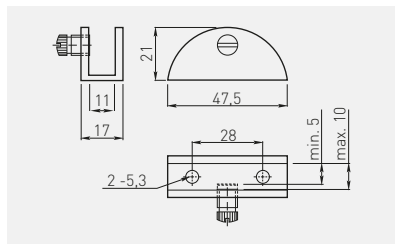

PP-HS2710-01	chrom / chróm / króm / crom	ZnAl



Policová podpěrka J63  
 Policová podperka J63  
 Poltartó J63  
 Suport raft J63

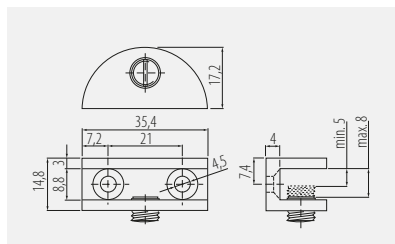





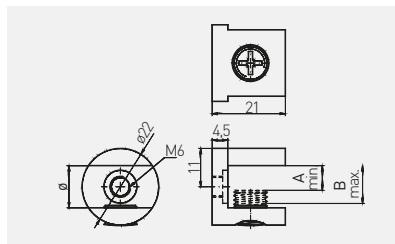

MC-J63-01	chrom / chróm / króm / crom	ZnAl
MC-J63-05	kartáčovaná ocel / kartáčovaná ocel / szálcsiszolt acél / oțel periat	



Policová podpěrka J65  
 Policová podperka J65  
 Polctartó J65  
 Suport raft J65





		 mm	 mm	 mm			
MC-J65-08-01		8	4	8	chrom / chróm / króm / crom		ZnAl
MC-J65-08-05		8	4	8	kartáčovaná ocel / kartáčená ocel / szálcsiszolt acél / oțel periat		
MC-J65-10-01		10	6	10	chrom / chróm / króm / crom		
MC-J65-10-05		10	6	10	kartáčovaná ocel / kartáčená ocel / szálcsiszolt acél / oțel periat		
MC-J65-12-01		12	7	11	chrom / chróm / króm / crom		
MC-J65-12-05		12	7	11	kartáčovaná ocel / kartáčená ocel / szálcsiszolt acél / oțel periat		

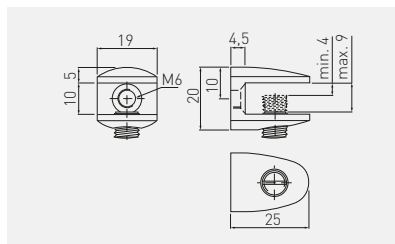

Policová podpěrka J123  
 Policová podperka J123  
 Polctartó J123  
 Suport raft J123



			
MC-J123-01		chrom / chróm / króm / crom	ZnAl
MC-J123-05		kartáčovaná ocel / kartáčená ocel / szálcsiszolt acél / oțel periat	



Policová podpěrka K135  
 Policová podperka K135  
 Polctartó K135  
 Suport raft K135

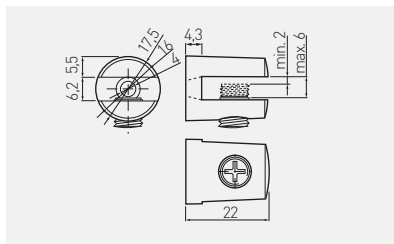

MC-K135-06-01	chrom / chróm / króm / crom	ZnAl



Držák skleněné desky J01  
 Podperka na sklo J01  
 Rögzítőelem J01  
 Suport J01

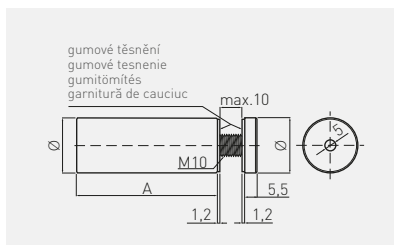

	mm	mm					
MC-J01A-12-01	12	16,5	chrom / chróm / króm / crom				
MC-J01A-12-06			kartáčovaná ocel / kartáčovaná ocel / szálcsiszolt acél / ojel periat				
MC-J01A-16-01	16	25	chrom / chróm / króm / crom				
MC-J01A-16-06			kartáčovaná ocel / kartáčovaná ocel / szálcsiszolt acél / ojel periat				





Podpěra J04  
Podperka J04  
Rögztőelem J04  
Suport J04

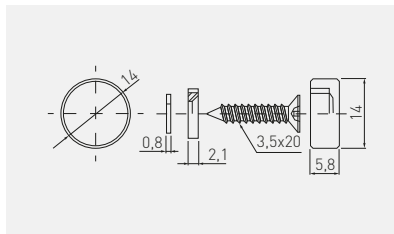

MC-J04A2-14-01	14	chrom / chróm / króm / crom	ZnAl	300
MC-J04A2-14-05	14	kartáčovaná ocel / kartáčovaná ocel / szálcsiszolt acél / oţel periat		200
MC-J04A2-18-01	18	chrom / chróm / króm / crom		100
MC-J04A2-22-01	22	chrom / chróm / króm / crom		



Držák skla J60  
Podperka J60  
Rögztőelem J60  
Suport J60

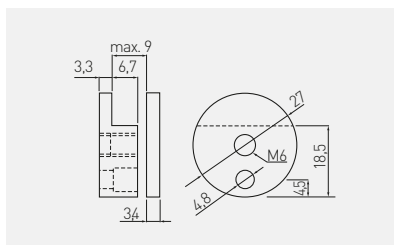

MC-J60A27-01	chrom / chróm / króm / crom	ZnAl



Držák skla J62  
 Podperka J62  
 Rögztőelem J62  
 Suport J62

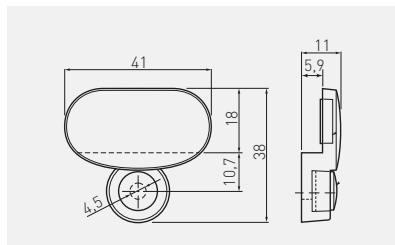

		
MC-J62-01	chrom / chróm / króm / crom	ZnAl



Policová podpěra GL  
 Policová podpera GL  
 Poltartó GL  
 Suport raft GL

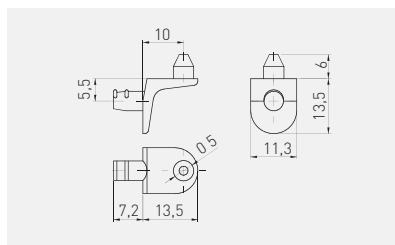

		
PP-GL-DR5-01	chrom / chróm / króm / crom	ZnAl



Policová podpěra SAFETY  
 Policová podpera SAFETY  
 Polctartó SAFETY  
 Suport raft SAFETY

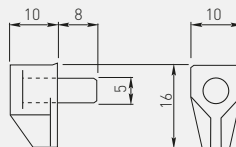

PP-SPL001-01	průhledný, priehľadná, átlátszó, transparent	ocel + plast, ocel + plast, acél + műanyag, oțel + plastic



Policová podpěra MR-11  
 Policová podpera MR-11  
 Polctartó MR-11  
 Suport raft MR-11

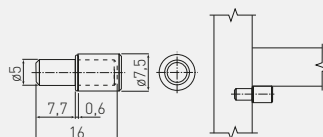

MR-ZSL011-01	s plastovým návlekom, s plastovým návlekom, műanyag bevonattal cu acoperire din plastic	chrom / chróm / króm / crom	ocel ocel acél oțel
MR-TDL011-01	bez plastového návleku, bez plastového návleku, műanyag bevonat nélkü fără acoperire din plastic		



Policová podpěra SMART  
 Policová podpera SMART  
 Polctartó SMART  
 Suport raft SMART

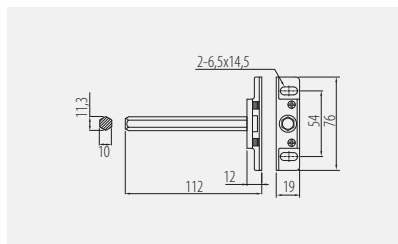

PP-SMART-000	stříbrný / stříborná / ezüst / argint	ocel / ocel / acél / oțel



Policová podpěra CLEAR  
 Policová podpera CLEAR  
 Polctartó CLEAR  
 Suport raft CLEAR

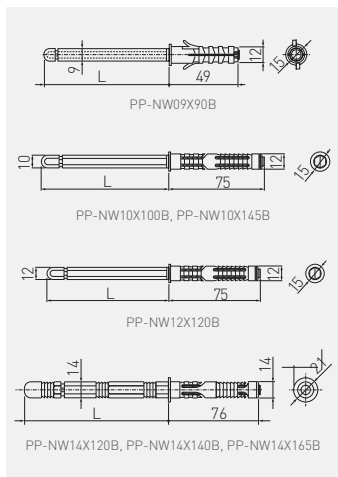

	mm	mm	kg				
PP-NW09X90B	9	90	10	hnědá, hnedá, barna, maro	ocel ocel acél oțel		
PP-NW10X100B	10	110	15				
PP-NW10X145B	10	145	15				
PP-NW12X120B	12	120	15				
PP-NW14X120B	14	120	25				
PP-NW14X140B	14	140	25				
PP-NW14X165B	14	165	25				



Podpěra LUK  
 Podpera LUK pod policu  
 Polctartó konzol LUK  
 Suport pentru raft LUK

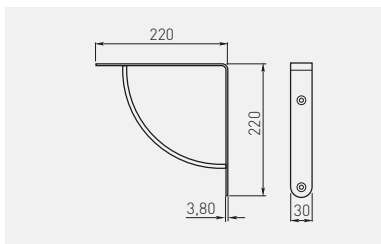

PP-LUK-00-01		30 / 2 ks	chrom / chróm / króm / crom	ocel ocel acél oțel
PP-LUK-00-02		30 / 2 ks	satén / satén / szatén / satin	
PP-LUK-00-05		30 / 2 db	hliník / hliník / alumínium / aluminiiu	



Podpěra WB-24  
 Podpera WB-24 pod policu  
 Polctartó konzol WB-24  
 Suport pentru raft WB-24

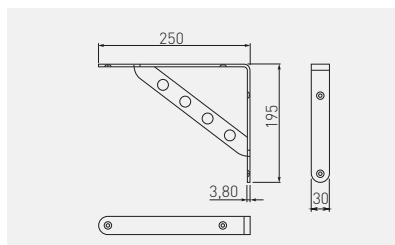

WB-073024-01		30 / 2 ks	chrom / chróm / króm / crom	ocel ocel acél oțel
WB-073024-06		30 / 2 ks	kartáčovaná ocel / kartáčovaná ocel / szálcsiszolt acél / oțel periat	



Podpěra WB-25  
 Podpera WB-25 pod policu  
 Polctartó konzol WB-25  
 Suport pentru raft WB-25

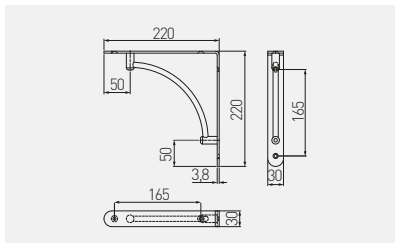

WB-073025-01	30 / 2 ks 30 / 2 ks	chrom / chróm / króm / crom	ocel ocel
WB-073025-06	30 / 2 db 30 / 2 buc	kartáčovaná ocel / kartáčovaná ocel / szálcsiszolt acél / oțel periat	acél oțel



Podpěra WB-26  
 Podpera WB-26 pod policu  
 Polctartó konzol WB-26  
 Suport pentru raft WB-26

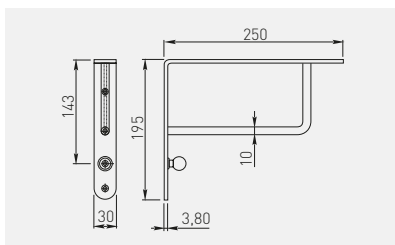

WB-073026-01	30 / 2 ks 30 / 2 ks	chrom / chróm / króm / crom	ocel ocel
WB-073026-06	30 / 2 db 30 / 2 buc	kartáčovaná ocel / kartáčovaná ocel / szálcsiszolt acél / oțel periat	acél oțel



Podpěra WS12  
 Podpera WS12  
 Poltartó konzol WS12  
 Suport pentru raft WS12

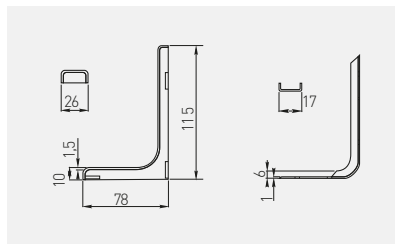

WB-WS-12-010	120	8 / 2 ks 8 / 2 ks 8 / 2 db 8 / 2 buc	bílá / biela / fehér / alb	plast, plast, műanyag, plastic



Podpěra WS18  
 Podpera WS18  
 Poltartó konzol WS18  
 Suport pentru raft WS18

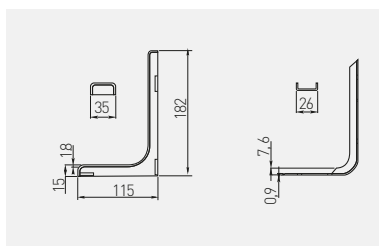

WB-WS-18-010	180	9,5 / 2 ks 9,5 / 2 ks 9,5 / 2 db 9,5 / 2 buc	bílá / biela / fehér / alb	plast, plast, műanyag, plastic
WB-WS-18-020	180		černá / čierna / fekete / negru	
WB-WS-18-060	180		šedá / sivá / szürke / gri	



Podpěra WS24  
 Podpera WS24  
 Poltartó konzol WS24  
 Suport pentru raft WS24

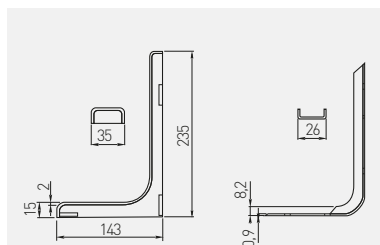





		 L mm	 kg		
WB-WS-24-010		240	11 / 2 ks	bílá / biela / fehér / alb	plast, plast, műanyag, plastic
WB-WS-24-020		240	11 / 2 ks 11 / 2 db	černá / čierna / fekete / negru	

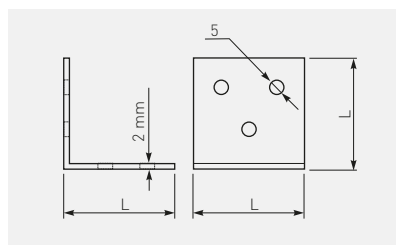

Úhelník FS01  
 Uholník FS01  
 Sarokvas FS01  
 Suport unghiular FS01



		 L mm			
KW-FS0125-01		25 x 25 x 24	chrom / chróm / króm / crom	ocel océl acél oțel	1500
KW-FS0140-01		40 x 40 x 40			400





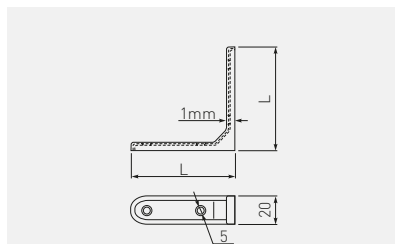



Úhelník FS03, vyztužený  
 Uholník FS03, vyztužený  
 Sarokvas erősítet FS03  
 Suport unghiular FS03 întărit

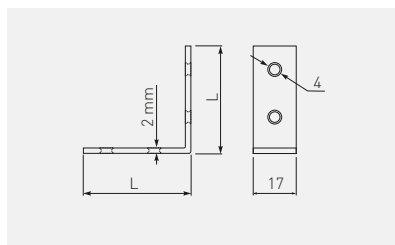

	 L mm			
KW-FS0335-01	35 x 35 x 20	chrom / chróm / króm / crom	ocel ocel acél oțel	1300
KW-FS0350-01	50 x 50 x 20			700
KW-FS0375-01	75 x 75 x 20			400

Úhelník FS04, standardní  
 Uholník FS04, štandardný  
 Sarokvas FS04  
 Suport unghiular FS04 standard



	 L mm			
KW-FS0425-03	25 x 25 x 17	mosaz / mosadz / sárgaréz / alamă	ocel ocel acél oțel	1500
KW-FS0450-03	50 x 50 x 17			600

Úhelník FS06  
 Uholník FS06  
 Sarok tartó FS06  
 Suport de colț FS06

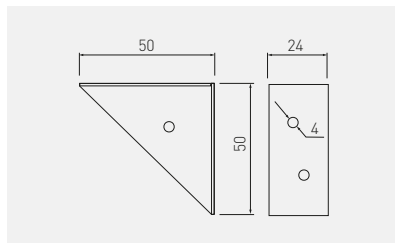

			
KW-FS0650-01	50 x 50 x 24 mm	chrom / chróm / króm / crom	ocel / ocel / acél / oțel



Spojovací úhelník MONT - plastový  
 Spojovací uholník MONT - plastový  
 Egyes rozgítőelem MONT  
 Suport de colț MONT unic

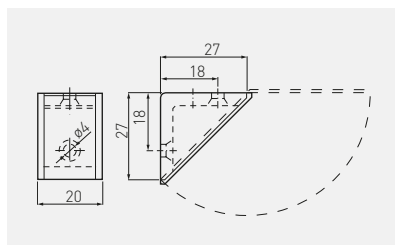

		
PP-PMONT0M-01*	bílá / biela / fehér / alb	plast, plast, műanyag, plastic
PP-PMONT0M-07*	tmavě hnědá / tmavo hnedá / sötétbarna / maro inchis	
PP-PMONT0M-08*	šedá / sivá / szürke / gri	
PP-PMONT0M-22*	slonová kost / slonová kost / elefántcsont / fildeş	



\*K dispozici pro speciální objednávky / K dispozicii na špeciálne objednávky / Külön megrendelésben kapható / Disponibil pentru comenzi speciale

Spojovací úhelník MONT velký - plastový  
 Spojovací uholník MONT veľký - plastový  
 Dupla rozgítőelem MONT  
 Suport de colț MONT dublu

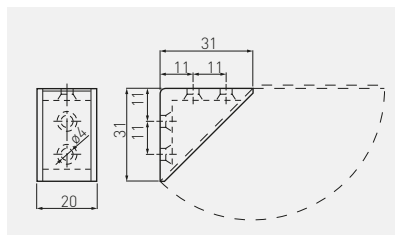





		
PP-PMONT00-22*	slonová kost / slonová kost / elefántcsont / fildeş	plast, plast, műanyag, plastic

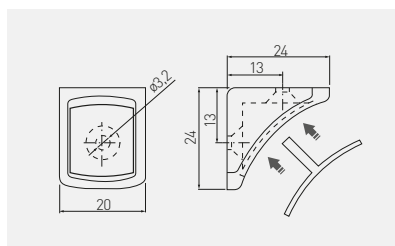

\*K dispozícii pro speciální objednávky / K dispozícii na špeciálne objednávky / Külön megrendelésben kapható / Disponibil pentru comenzi speciale

Spojovací úhelník NARS - plastový  
 Spojovací uholník NARS - plastový  
 Egyes rozgítőelem NARS  
 Suport de colț NARS unic



		
PM-NAR1003-11	slonová kost / slonová kost / elefántcsont / fildeş	plast, plast, műanyag, plastic
PM-NAR1003-19	šedá / sivá / szürke / gri	
PM-NAR1003-10	bílá / biela / fehér / alb	



\*K dispozícii pro speciální objednávky / K dispozícii na špeciálne objednávky / Külön megrendelésben kapható / Disponibil pentru comenzi speciale

Spojovací úhelník NARS - dvojité  
 Spojovací uholník NARS - dvojité  
 Dupla rozžitőellem NARS  
 Suport de colț NARS dublu

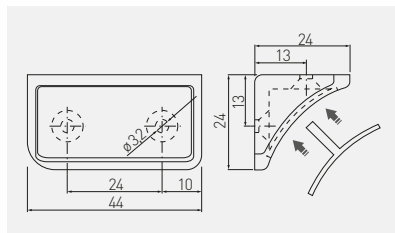

PM-NAR1004-11	slonová kost / slonová kost / elefántcsont / fildeş	plast, plast, műanyag, plastic
PM-NAR1004-19	šedá / sivá / szürke / gri	
PM-NAR1004-10	bilá / biela / fehér / alb	



\*K dispozici pro speciální objednávky / K dispozici na špeciálne objednávky / Külön megrendelésben kapható / Disponibil pentru comenzi speciale

Stabilizátor zadní stěny  
 Stabilizátor zadnej steny  
 Hatso stabilizator  
 Stabilizator spate

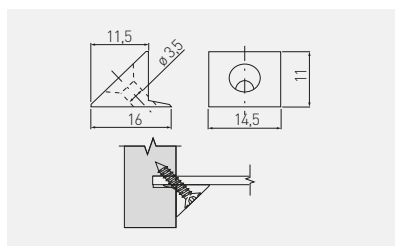

WZ-SCTYLPR-WK	se šroubem 3,5 x 20 so skrutkou 3,5 x 20 3,5 x 20 csavarral cu șurub 3,5 x 20	průhledný, priehľadná, átlátszó, transparent	plast, plast, műanyag, plastic
WZ-SCTYLPR-BWK	bez šroubu bez skrutky csavar nélkül fără șurub		



Rektifikační kování FORCE  
 Rektifikačné kovanie FORCE  
 Fém butorakasztó FORCE  
 Agatator de bucătărie invizibil FORCE

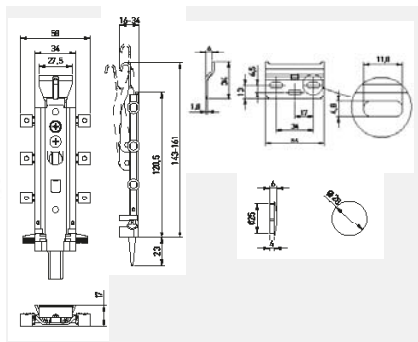

ZK-FORCE-KPL	100 / 2 ks 100 / 2 ks 100 / 2 db 100 / 2 buc	stříbrný / stříborná / ezüst / argint	ZnAl + ocel / ZnAl + ocel / ZnAl + acél / ZnAl + oţel
--------------	---	---------------------------------------	---



Rektifikační kování R0  
 Rektifikačné kovanie R0  
 Konyhai akasztó állítható R0  
 Agatator de bucătărie R0 reglabil

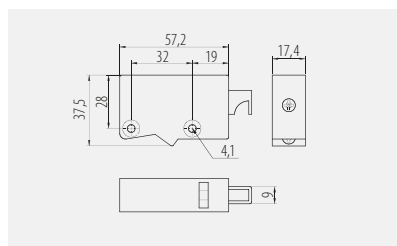

ZK-ZAW-R0-10	50 / 2 ks 50 / 2 ks 50 / 2 db 50 / 2 buc	bílá / biela / fehéř / alb	ocel + plast, ocel + plast, acél + műanyag, oţel + plastic
ZK-ZAW-R0-30		hnědá / hnedá / barna / maro	



Rektifikační kování R1  
 Rektifikačné kovanie R1  
 Konyhai akasztó R1  
 Agatator de bucatărie R1

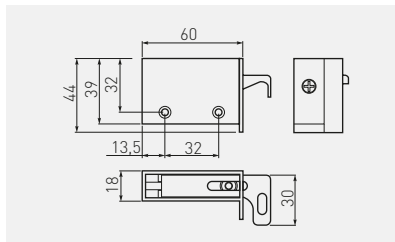





			
ZK-R1-KPL-10	90 / 2 ks 90 / 2 ks 90 / 2 db 90 / 2 buc	bílá / biela / fehér / alb	ocel + plast, ocel + plast, acél + műanyag, oțel + plastic

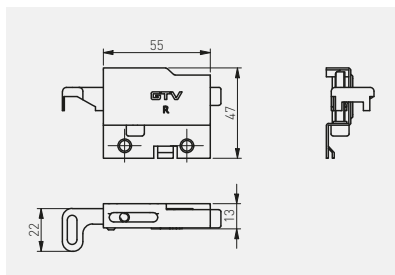

Rektifikační kování Forza  
 Rektifikačné kovanie Forza  
 Konyhai akasztó Forza  
 Agatator de bucatărie Forza



				
ZK-FORZA-ZAW-KPL	130 / 2 ks 130 / 2 ks 130 / 2 db 130 / 2 buc	1 sada = L + P 1 súpava = L + P 1 készlet = L + R 1 set = L + R	stříbrný, striebrná, ezüst, argint	ocel + plast, ocel + plast, acél + műanyag, oțel + plastic



Krytka rektifikačního kování Forza  
 Krytka rektifikačného kovania Forza  
 Akasztó kupakok Forza  
 Capac pentru agatator de bucatarie Forza

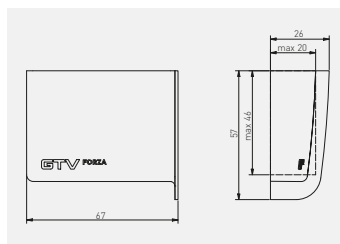

ZK-FORZA-ZAS-KPL-010	1 sada = L + P 1 súprava = L+P 1 készlet = L+R 1 set = L+R	biť / biela / fehér / atb	plast, plast, műanyag, plastic
ZK-FORZA-ZAS-KPL-020		černá / čierna / fekete / negru	



Montážní lišta  
 Montážna lišta  
 Szerelő szalag  
 Sina corp suspendat

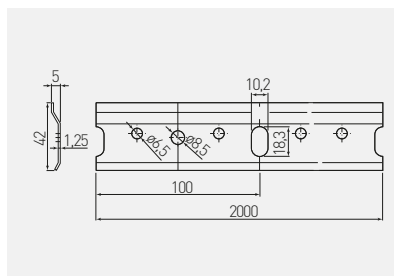

LO-M2M-00-125-A	2000	pozinkovaný pozinkovaný galvanizált galvanizat	ocel ocel acél oțel



Spojovací kování pro pracovní desky  
Spojovacie kovanie pre pracovné desky  
Rejtett munkalap csatlakozó  
Conector ascuns al blatului

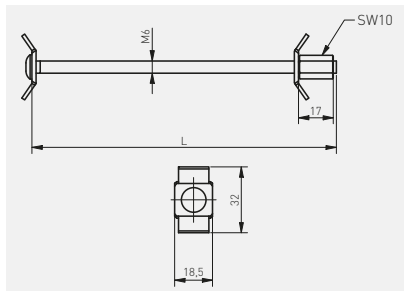

	L mm		
EM-SBL065-01-A	65	chrom / chróm / króm / crom	ocel ocel acél oțel
EM-SBL100-01-A	100		
EM-SBL150-01-A	150		



Excentrické spojovací kování pro police  
Excentrické spojovacie kovanie pre police  
Excentrikus csatlakozó szerelvény polcokhoz  
Fiting de conectare excentric pentru rafturi

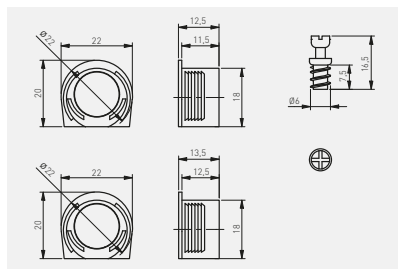

	Ø mm			
MM-FI20X6X7-PL10-A-1T	20	hmoždinka 6 x 16,5 mm rozpera 6 x 16,5 mm tiplí 6 x 16,5 mm diblu 6 x 16,5 mm	bílá / biela / fehér / alb	ZnAl + plast, ZnAl + plast, ZnAl + műanyag, ZnAl + plastic
MM-FI20X6X7-PL20-A-1T			černá / čierna / fekete / negru	
MM-FI20X6X7-PL30-A-1T			hnědá / hnedá / barna / maro	
MM-FI20X6X7-PL80-A-1T			šedá / sivá / szürke / gri	
MM-FI20X6X7-ZN-A-1T			stříbrný / strieborná / ezüst / argint	





Spojovací kování (šroub+matka)  
Spojovacie kovanie (skrutka + matka)  
Butorosszehuzo csavar  
Surub cuplare mobila



SZ-005-00-01T  
SZ-008-00-01T



SZ-005-00-01-AT  
SZ-008-00-01-AT

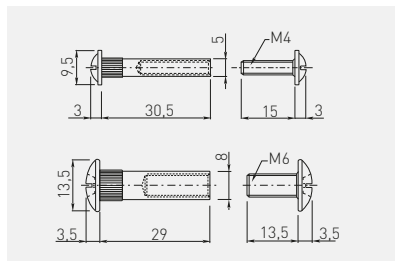

SZ-005-00-01T	5	chrom / chróm / króm / crom	ocel ocel acél oțel
SZ-005-00-01-AT			
SZ-008-00-01T	8		
SZ-008-00-01-AT			



Vruty do dřeva  
Skrutky do dreva  
Facsavar  
Șurub pentru lemn

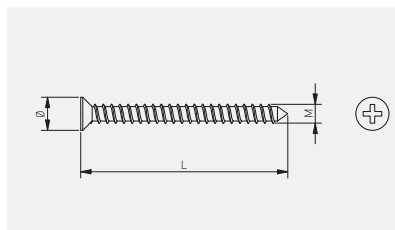

WK-D0320-001*	3 x 20	chrom chróm króm crom	ocel ocel acél oțel
WK-D0325-001*	3 x 25		
WK-D0330-001*	3 x 30		
WK-D0416-001	4 x 16		
WK-D0425-001*	4 x 25		



WK-D0430-001	4 x 30	chrom chróm króm crom	ocel ocel acél oțel
WK-D0440-001*	4 x 40		
WK-D0460-001*	4 x 60		
WK-D3516-001	3,5 x 16		
WK-D3530-001	3,5 x 30		

\*K dispozici pro speciální objednávky / K dispozícii na špeciálne objednávky / Külön megrendelésben kapható / Disponibil pentru comenzi speciale



Excentrické spojovací kování F115X12 mm  
 Excentrické spojovacie kovanie F115X12 mm  
 Excentrikus csatlakozó szerelvény F115X12 mm  
 Conector excentric F115X12 mm

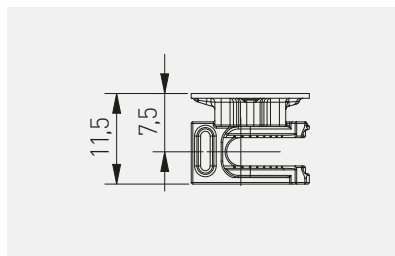

WK-CAM-15-12-D	Ø15 x 12	stříbrný / stříborná / ezüst / argint	ZnAl
WK-CAM-15-13-D*	Ø15 x 13		



\*

Táhlo excentru  
 Tiaho excentra  
 Csavar excentrikus csatlakozó szerelvényhez  
 Șurub pentru conector excentric

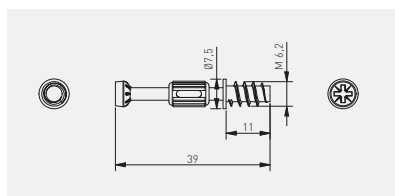





WK-DOW63X45B-D	6,3 x 45	stříbrný, černá stříborná, čierna ezüst, fekete argint, negru	ocel + plast, ocel + plast, acél + műanyag, oțel + plastic
WK-DOW63X39-D	6,3 x 39	stříbrný, červená stříborná, červená ezüst, piros argint, roșu	
WK-DOW63X35B-D	6,3 x 35	stříbrný, zelená stříborná, zelená	
WK-DOW63X31G-D	6,3 x 31	ezüst, zöld argint, verde	



Komplet excentr + táhlo  
Súprava excentr + kolík  
Excentrikus elem és csap készlet  
Set excentric și știft



	 mm		
WK-CAM-15-DOW63X45-KPL-1T	6,3 x 45	stříbrný, černá stříborná, čierna ezüst, fekete argint, negru	ocel + plast + ZnAl, ocet + plast + ZnAl, acél + műanyag + ZnAl, oțel + plastic + ZnAl
WK-CAM-15-DOW63X39-KPL-1T	6,3 x 39	stříbrný, červená stříborná, červená ezüst, piros argint, roșu	
WK-CAM-15-DOW63X35-KPL-1T	6,3 x 35	stříbrný, zelená stříborná, zelená ezüst, zöld argint, verde	
WK-CAM-15-DOW63X31-KPL-1T	6,3 x 31		



\*K dispozicii pro speciální objednávky / K dispozicii na špeciálne objednávky / Külön megrendelésben kapható / Disponibil pentru comenzi speciale

Konfirmát  
Konfirmát  
Konfirmat csavar \*  
Șurub confirmator \*

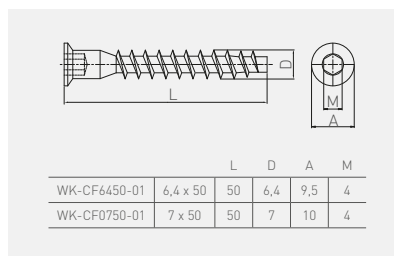

		
WK-CF6450-01*	chrom / chróm / króm / crom	ocel ocet acél oțel
WK-CF0750-01*		



\*K dispozicii pro speciální objednávky / K dispozicii na špeciálne objednávky / Külön megrendelésben kapható / Disponibil pentru comenzi speciale

Magnet MENSA  
Magnet MENSA  
Magnescsappantu MENSA  
Opritor magnetic MENSA

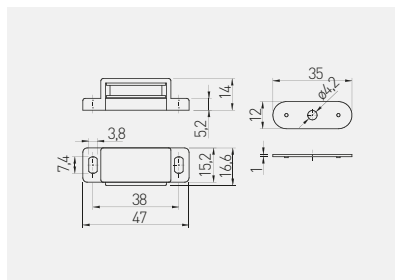





		
MG-MENSA-010	bílá / biela / fehé / alb	ocel + plast, ocel + plast, océl + műanyag, oțel + plastic
MG-MENSA-030	hnědá / hnedá / barna / maro	

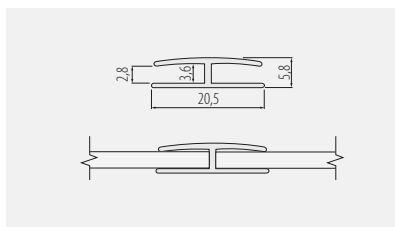

Spojovací profil zad PFM - typ H  
Spojovací profil zad PFM - typ H  
Butorprofil PFM - H típus  
Profil pentru mobilă PFM - tip H



			
PM-PFMH51-10*	2000	tmavě hnědá / tmavo hnedá / sötétbarna / maro inchis	plast plast műanyag plastic
PM-PFMH61-10*	2000	tmavý mahagon / tmavý mahagón / sötét mahagóni / mahon întunecat	
PM-PFMH50-24*	2400	bílá / biela / fehé / alb	
PM-PFMH50-25*	2500	bílá / biela / fehé / alb	
PM-PFMH55-25*	2500	černá / čierna / fekete / negru	
PM-PFMH64-25*	2500	mahagon / mahagón / mahagóni / mahon	



Plochá ozdobná lišta  
 Plochá ozdobná lišta  
 Öntapadós díszléc  
 Benzi decorative plate



Samolepicí páska  
 Samolepiaca páska  
 Öntapadó szalag  
 Bandă autoadezivă

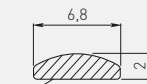

LO-00-00-001*	2000	chrom / chróm / króm / crom	plast plast műanyag plastic
LO-00-00-003	2000	mosaz / mosadz / sárgaréz / alamă	



\*K dispozici pro speciální objednávky / K dispozícii na špeciálne objednávky / Külön megrendelésben kapható / Disponibil pentru comenzi speciale

Boční lišta na pracovní desky 38  
 Bočná lišta na pracovné dosky  
 Lemezék oldalso profilja 38  
 Terminatie blat 38

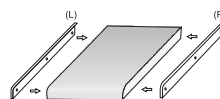

Pro pracovní desky o tloušťce 38 mm  
 Pre pracovné dosky s hrúbkou 38 mm  
 38 mm vastag munkalapokhoz  
 Pentru blaturi de lucru 38 mm grosime

LMB-BOCZ38L-05	levý / favý / bal / stánga	600	hliník / hliník / alumínium / aluminiu	hliník hliník alumínium aluminiiu
LMB-BOCZ38L-20M			černá / čierna / fekete / negru	
LMB-BOCZ38P-05	pravé / pravý / jobb / dreapta		hliník / hliník / alumínium / aluminiu	
LMB-BOCZ38P-20M	černá / čierna / fekete / negru			



Spojovací lišta pro pracovní desky - rohová 38  
 Spojovacia lišta pre pracovné dosky - rohová 38  
 Munkalap Fordító 38  
 Terminatie blat unghiular 38

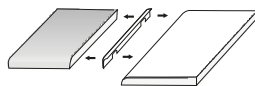

Pro pracovní desky o tloušťce 38 mm  
 Pre pracovné dosky s hrúbkou 38 mm  
 38 mm vastag munkalapokhoz  
 Pentru blaturi de lucru 38 mm grosime



LMB-KAT38-05	600	hliník / hliník / aluminium / aluminii	hliník hliník aluminium aluminii
LMB-KAT38-20M		černá / čierna / fekete / negru	



\*K dispozici pro speciální objednávky / K dispozicii na špeciálne objednávky / Külön megrendelésben kapható / Disponibil pentru comenzi speciale



Spojovací lišta pro pracovní desky - prodlužovací 38  
 Spojovacia lišta pre pracovné dosky - predlžovacia 38  
 Munkalap Toldo 38  
 Imbinare a blatului 38

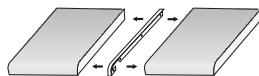

Pro pracovní desky o tloušťce 38 mm  
 Pre pracovné dosky s hrúbkou 38 mm  
 38 mm vastag munkalapokhoz  
 Pentru blaturi de lucru 38 mm grosime

			
LMB-SZCZ38-05	600	hliník / hliník / alumínium / aluminiu	hliník hliník alumínium aluminiu
LMB-SZCZ38-20M		černá / čierna / fekete / negru	



Šatní tyč oválná  
 Šatníková tyč oválná  
 Ruharud, ovális  
 Bara de garderobă ovală

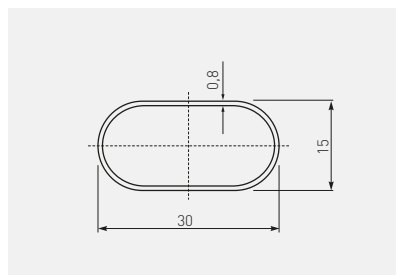

			
RR-CH-OW-000	3000	chrom / chróm / króm / crom	ocel / ocel / acél / oțel



Držák šatní tyče oválné  
 Držiak šatníkovej tyče oválnej  
 Ruharudtarto, ovalis RDR  
 Suport de montare RDR pentru bara de garderobă ovală

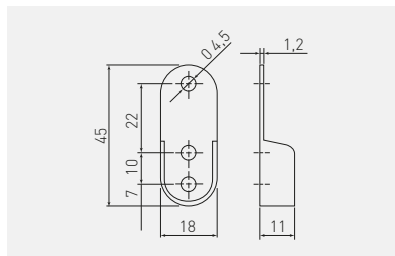

MR-RDR0-0000



chrom / chróm / króm / crom



ocel / ocel / acél / oțel



Držák šatní tyče oválné - průběžný  
 Držiak WP-28 pre oválnu šatníkovej tyč  
 Állítható fuggóleges ovalis rudtarto WP-28  
 Suport unghiular WP-28 pentru bara ovală

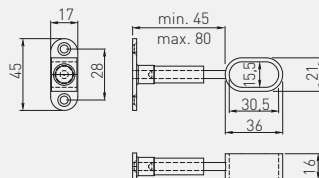

MR-WP-028-01



chrom / chróm / króm / crom





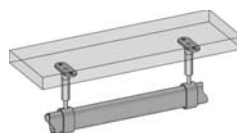



ZnAl

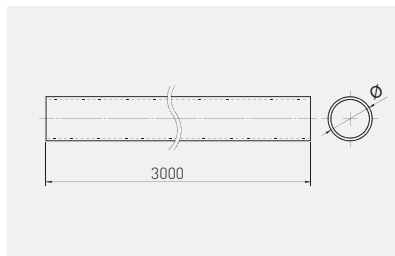









Šatní tyč kulatá  
Šatníková tyč okrúhla  
Kerek akasztó Rud  
Bara de garderobă rotundă



		 mm	 mm	 mm		
RR-161030H01		16	1	3000	chrom chróm króm crom	ocel ocel acél oțel
RR-161230H01		16	1,2			
RR-250730H01		25	0,7			
RR-250830H01		25	0,8			
RR-250930H01		25	0,9			

		 mm	 mm	 mm		
RR-251030H01		25	1	3000	chrom chróm króm crom	ocel ocel acél oțel
RR-401230H01*		40	1,2			
RR-501030H01		50	1			
RR-501230H01		50	1,2			



\*K dispozici pro speciální objednávky / K dispozicii na špeciálne objednávky / Külön megrendelésben kapható / Disponibil pentru comenzi speciale

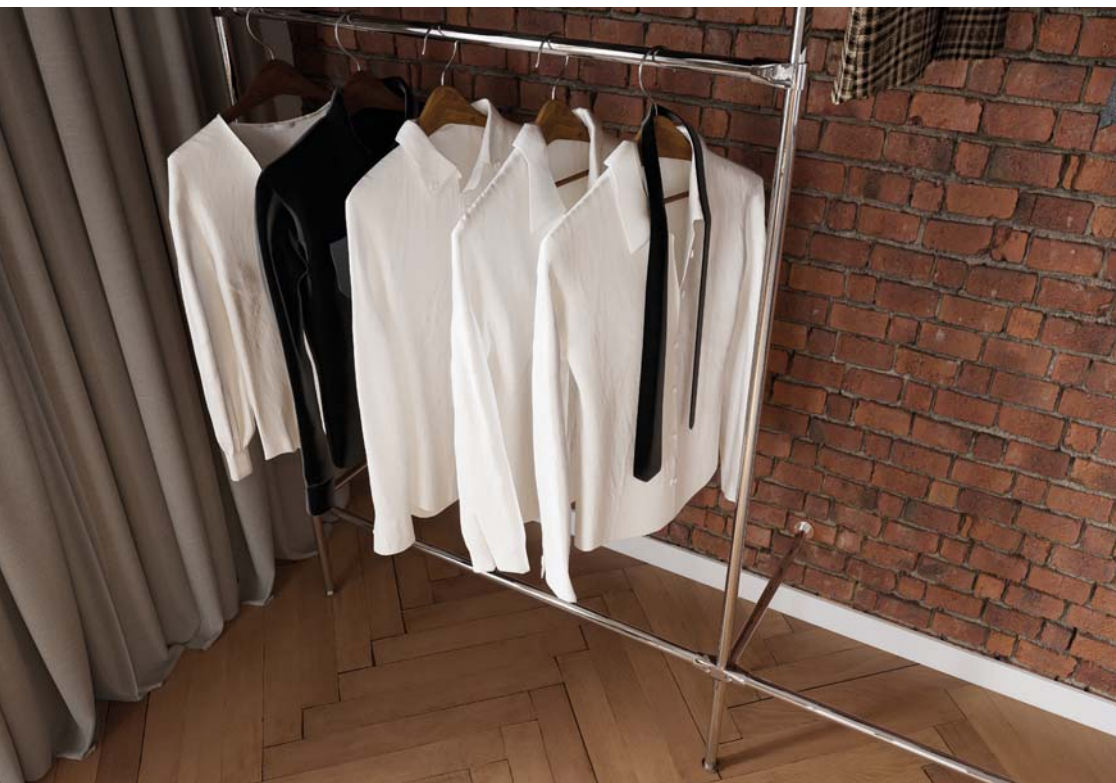

Držák šatní tyče kulaté pr. 25 mm  
 Držiak okrúhlej tyče pr. 25 mm  
 Akasztórud tarto R-25  
 Suport de montare R-25 pentru bara rotundă

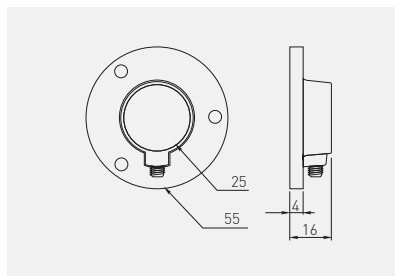

MR-RS025-001	25 mm	chrom / chróm / króm / crom	ocel / ocel' / acél / oțel



Držák kulaté R-50 tyče pr. 50 mm  
 Držiak okrúhlej tyče pr. 50 mm  
 Akasztórud tarto R-50  
 Suport de montare R-50 pentru bara rotundă

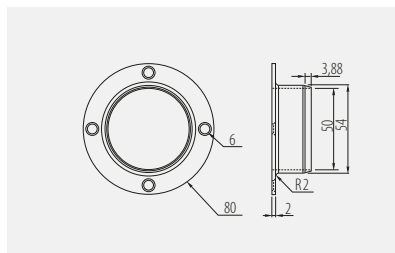

MR-R0050-001	50 mm	chrom / chróm / króm / crom	ocel / ocel' / acél / oțel



Spodní příchyt PZ-2 tyče 50 mm  
 Spodné upevnenie PZ-2 ku okrúhlemu profilu  
 Alsokonzol konyhaoszlophoz PZ-2  
 Suport de montaj inferior PZ-2 pentru bara rotundă

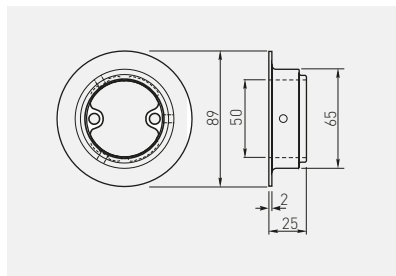

	 mm		
MR-WPZ002-01	50	chrom / chróm / króm / crom	ocel / ocel / acél / otjel



Rozeta PZ-3 tyče 50 mm  
 Rozeta PZ-3 tyče 50 mm  
 Rögzítőgyűrű konyhaoszlophoz PZ-3  
 Inel de montare PZ-3

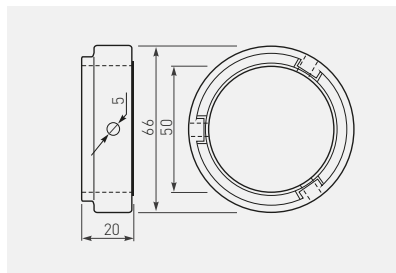

	 mm		
MR-WPZ003-01	50	chrom / chróm / króm / crom	ZnAl



Držák šatní tyče kulaté - průběžný WP-10  
 Držiak šatníkovej tyče WP-10  
 Állítható függőleges csőtartó WP-10  
 Suport de sprijin WP-10, reglabil

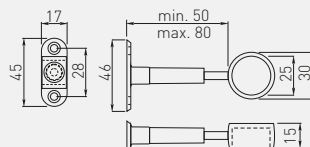

	 mm		
MR-WP-010-01	25	chrom / chróm / króm / crom	ZnAl



Držák šatní tyče kulaté - nastavitelný uzavřený WP-11  
 Držiak šatníkovej tyče WP-11 - uzavretý  
 Állítható függőleges csőtartó, végzárós WP-11  
 Suport de sprijin WP-11, reglabil cu capac

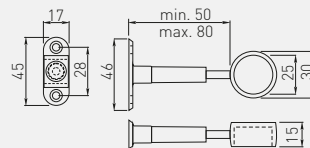

	 mm		
MR-WP-011-01	25	chrom / chróm / króm / crom	ZnAl



Držák šatní tyče průběžný THA-12  
 Držiak šatníkovej tyče THA-12  
 Távartó foganty THA-12  
 Suport de sprijin THA-12

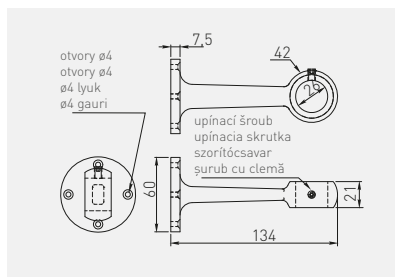

	 mm		
MR-THA12-001	25	chrom / chróm / króm / crom	ZnAl



Držák šatní tyče kulaté - uzavřený THB-12  
 Držiak šatníkovej tyče THB-12 - uzavretý  
 Távartó foganty THB-12  
 Suport de sprijin THB-12

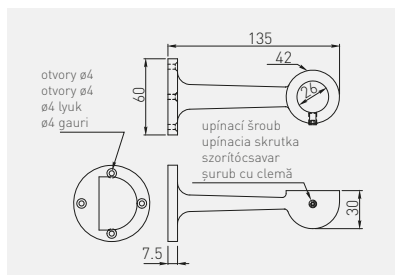

	 mm		
MR-THB12-001	25	chrom / chróm / króm / crom	ZnAl



Dvouramenný Spojovací díl TH-5  
Dvojramenný držiak TH-5  
Egyenes csatlakozo TH-5  
Conector TH-5

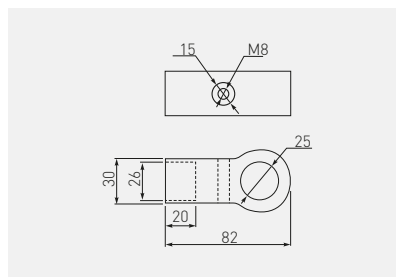

MR-TH005-001

25

chrom / chróm / króm / crom

ZnAl



Dvouramenný Spojovací díl TH-16  
Dvojramenný držiak TH-16  
Egyenes csatlakozo TH-16  
Conector TH-16

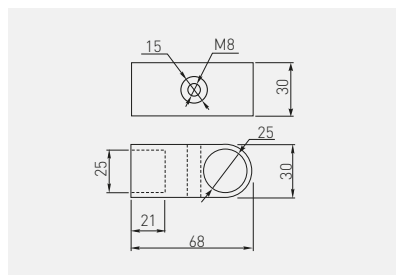

MR-TH016-001

25

chrom / chróm / króm / crom

ZnAl



Dvouramenný Spojovací díl TH-4 typ T  
Dvojramenný držiak TH-4 typ T  
T-típusú csatlakozó TH-4  
Conector TH-4 tip T.

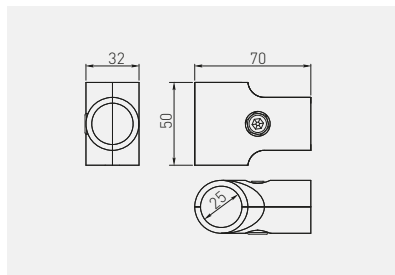

MR-TH004-001

25

chrom / chróm / króm / crom

ZnAl



Sada konektorů TH-18 typ L  
Sada konektorov TH-18 typ L  
L-típusú csatlakozó TH-18  
Conector TH-18 tip L.

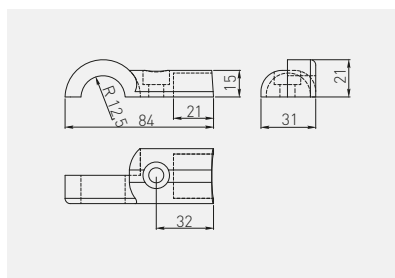

Možnost získání různých poloh připojení  
Možnosť získania rôznych polôh pripojenia  
Különböző csatlakozási pozíciók lehetőségé  
Posibilitatea de a obține diferite poziții de conexiune



MR-TH018-KPL

pravé / levé  
pravý / ľavý  
jobb / bal  
dreapta / stânga

25

chrom / chróm / króm / crom

ZnAl



Spojovací díl TH-9  
Držák TH-9  
TH-9 csatlakozó  
Conector TH-9

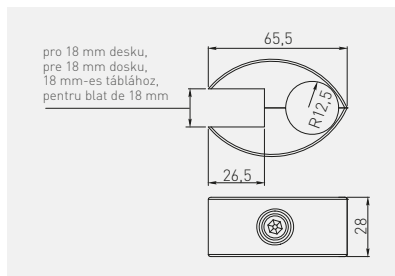

MR-TH009-001



chrom / chróm / króm / crom



ZnAl



Doporučená tloušťka skla s vložkami: 4 – 8 mm  
Odporúčaná hrúbka skla s vložkami: 4 – 8 mm  
Javasolt üvegvastagság betétekkel: 4-8 mm  
Grosimea recomandată a sticlei cu inserții: 4-8 mm

Sada konektorů TH-35  
Sada konektorov TH-35  
TH-35 csatlakozókészlet  
Set de conectori TH-35

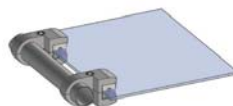
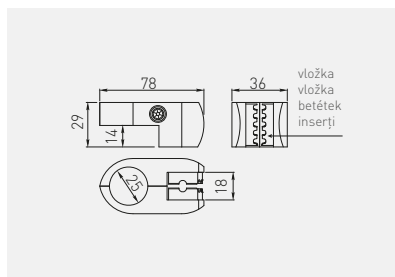

MR-TH035-KPL



25



chrom / chróm / króm / crom



ZnAl



Doporučená tloušťka skla s vložkami: 4 – 8 mm  
Odporúčaná hrúbka skla s vložkami: 4 – 8 mm  
Javasolt üvegvastagság betétekkel: 4-8 mm  
Grosimea recomandată a sticlei cu inserții: 4-8 mm



Dvoustranný spojovací díl WP-15  
 Dvojstranný držiak WP-15  
 Egyenes csatlakozo WP-15  
 Conector WP-15



seřizovací šrouby  
 nastavovacie skrutky  
 beállító csavarok  
 șuruburi de reglare

upevňovací šrouby  
 upevňovacie skrutky  
 rögzítőcsavarok  
 șuruburi de fixare

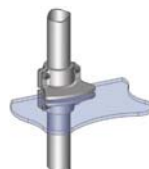
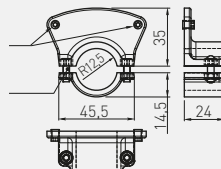

MR-WP-15-KPL	25	chrom / chróm / króm / crom	ZnAl
--------------	----	-----------------------------	------



Trojitý spojovací díl TH-2  
 Trojitý držiak TH-2  
 TH-2 csatlakozó háromutas  
 Conector TH-2 în trei direcții

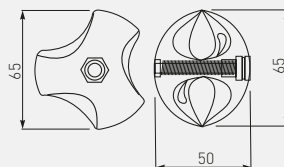

MR-TH002-L01	levý / ľavý / bal / stânga	chrom / chróm / króm / crom	ZnAl
MR-TH002-P01	pravé / pravý / jobb / dreapta		



Dvojitý spojovací díl TH-18  
Dvojitý držák TH-18  
TH-18 kettős csatlakozó  
Conector dublu TH-18

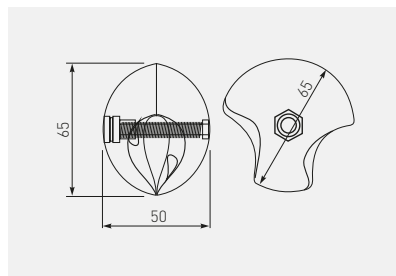

			
MR-TH018-L01	levý / ľavý / bal / stânga	chrom / chróm / króm / crom	ZnAl
MR-TH018-P01	pravé / pravý / jobb / dreapta		



Kulatá záslepka  
Okrúhla zátka  
Kerek zárókupak  
Capac de capăt rotund

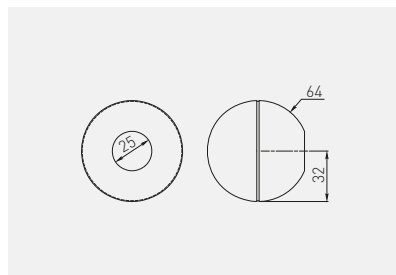

			
MR-THQZ1-001	25	chrom / chróm / króm / crom	ZnAl



Záslepka TH-19  
Zátka TH-19  
TH-19 végzáró  
Capac de capăt TH-19

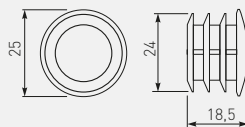

	 mm		
MR-TH019-001	25	chrom / chróm / króm / crom	ZnAl



Vnější plastová stavěcí nožka  
Vonkajšia plastová nastavovacia nôžka  
Műanyag zárósapka  
Capac de capăt din plastic

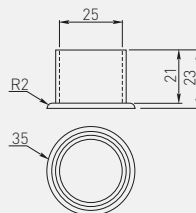

	 mm		
MR-TH019-003	25	černá čierna fekete negru	plast plast műanyag plastic



Držák tyče jednoduchý  
Držák tyče jednoduchý  
Relingscő kozéptartó  
Conector petru bara rotunda

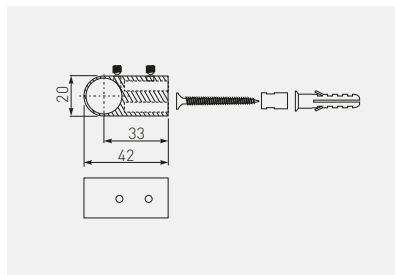

MR-WP2802-01

16

chrom / chróm / króm / crom

ZnAl



Záslepka tyče  
Záslepka tyče  
Végzáró  
Capac bara

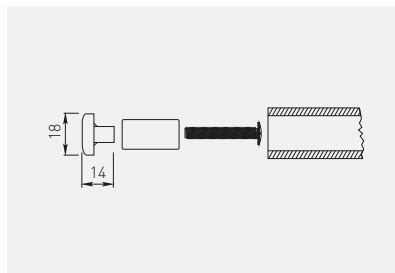

MR-WP2815-01

16

chrom / chróm / króm / crom

ZnAl



Držák tyče průběžný  
 Držák tyče  
 Relingcső kozéptartó  
 Conector petru bara rotunda

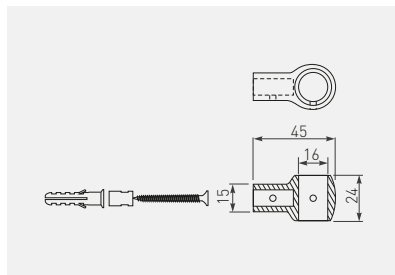

	 mm		
MR-WP2804-01	16	chrom / chróm / króm / crom	ZnAl



Záslepka  
 Záslepka  
 Végzáró  
 Capac bara

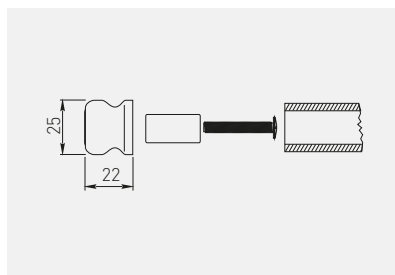

	 mm		
MR-WP2806-01	16	chrom / chróm / króm / crom	ocel + plast / ocel + plast / acél + műanyag / oțel + plastic



Vnitřní spojka tyčí  
Spojovací diel  
Relingscő toldó  
Conector bara rotunda

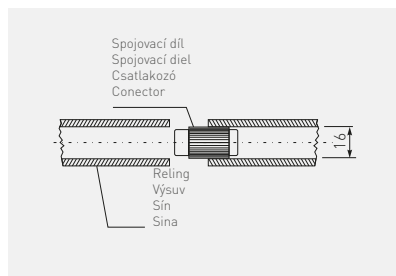

	 mm		
MR-WP2807-20	16	černá / čierna / fekete / negro	plast / plast / műanyag / plastic



Záslepka tyče se závitem  
Záslepka tyče so závitom  
Menetes végzáró relingscőhoz  
Capac de capăt cu filet pentru bara rotunda

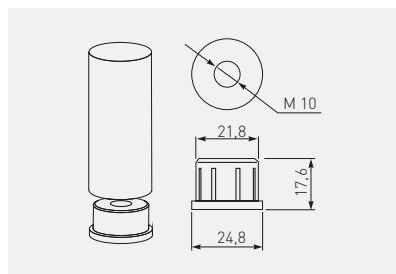

MR-WPZ023-01	chrom / chróm / króm / crom	ZnAl



Háčky k relingu PS1  
Háčiky k relingu PS1  
Relingcso "S" akasztó PS1  
Cârlige pentru bara PS1

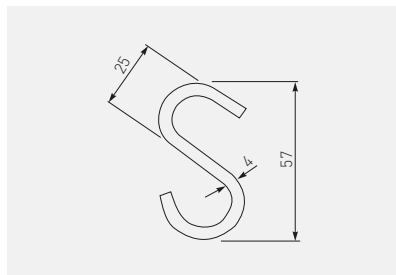

			
MR-WPS01-001	16	chrom / chróm / króm / crom	ocel / ocel / acél / oțel



Háčky k relingu PS3  
Háčiky k relingu PS3  
Relingcso "S" akasztó PS3  
Cârlige pentru bara PS3

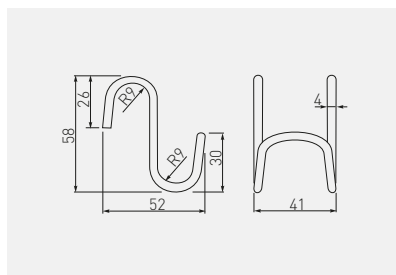





			
MR-WPS03-001	16	chrom / chróm / króm / crom	ocel / ocel / acél / oțel

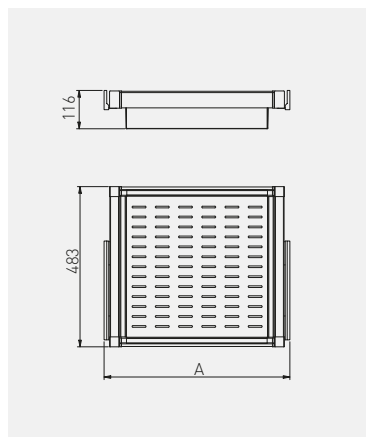

Zásuvka Elite kovová  
 Zásuvka Elite kovová  
 Fém kosár ELITE  
 Coș metallic ELITE





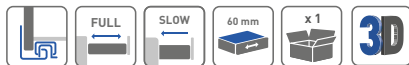



	A min./max.			
WG-KOSZM60-10	560 - 618	úplný úplný teljes complet	bílám biela fehér alb	ocel + plast, ocel + plast, acél + műanyag, oțel + plastic
WG-KOSZM70-10	660 - 718			
WG-KOSZM80-10	760 - 818			
WG-KOSZM90-10	860 - 918			
WG-KOSZM60-60	560 - 618		antracitová, antracitová, antracit, antracit	
WG-KOSZM70-60	660 - 718			
WG-KOSZM80-60	760 - 818			
WG-KOSZM90-60	860 - 918			

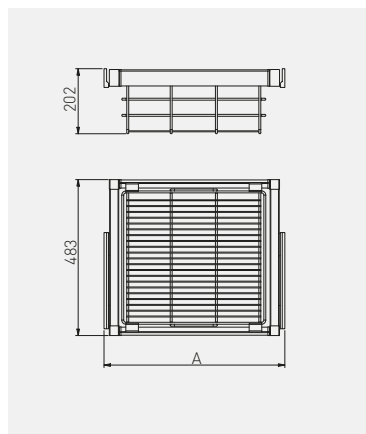



Zásuvka ELITE drátěná  
 Zásuvka ELITE drôtená  
 Áttört kosár ELITE  
 Coș ajurat ELITE





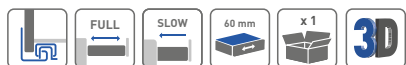

	A min./max.				
WG-KOSZ60-10	560 - 618	úplný úplný teljes complet		bílám biela fehér alb	
WG-KOSZ70-10	660 - 718				
WG-KOSZ80-10	760 - 818				
WG-KOSZ90-10	860 - 918				
WG-KOSZ60-60	560 - 618			antracitová, antracitová, antracit, antracit	ocel + plast, ocel + plast, acél + műanyag, oțel + plastic
WG-KOSZ70-60	660 - 718				
WG-KOSZ80-60	760 - 818				
WG-KOSZ90-60	860 - 918				

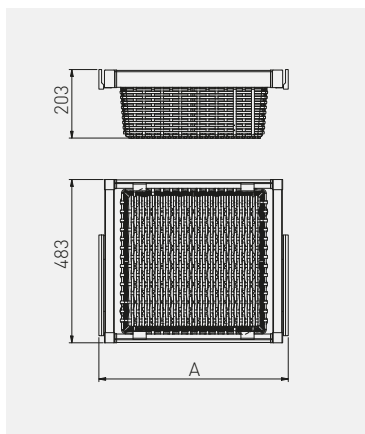

Zásuvka ELITE ratanová  
 Zásuvka ELITE ratanová  
 Rattan kosár ELITE  
 Coș din ratan ELITE



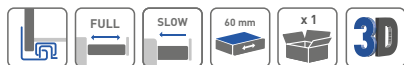

	A min./max.			
WG-KOSZR60-10	560 – 618	úplný úplný teljes complet	bílám biela fehér alb	ocel + plast, ocel + plast, acél + műanyag, oțel + plastic
WG-KOSZR70-10	660 – 718			
WG-KOSZR80-10	760 – 818			
WG-KOSZR90-10	860 – 918			
WG-KOSZR60-60	560 – 618		antracitová, antracitová, antracit, antracit	
WG-KOSZR70-60	660 – 718			
WG-KOSZR80-60	760 – 818			
WG-KOSZR90-60	860 – 918			

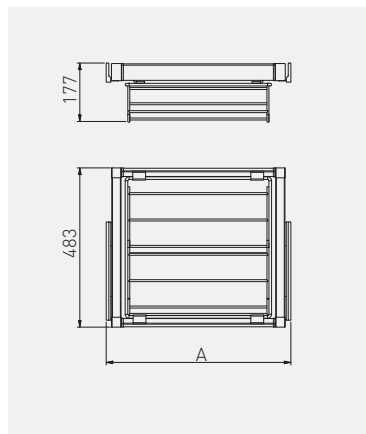

Zásuvka ELITE na obuv  
 Zásuvka ELITE na obuv  
 Cipőtartó ELITE kihuzható  
 Suportul pentru pantofi ELITE extensibil



	A min./max.			
WG-POBUW60-10	560 - 618	úplný úplný teljes complet	bílám biela fehér alb	ocel + plast, ocel + plast, acél + műanyag, oțel + plastic
WG-POBUW70-10	660 - 718			
WG-POBUW80-10	760 - 818			
WG-POBUW90-10	860 - 918			
WG-POBUW60-60	560 - 618		antracitová, antracitová, antracit, antracit	
WG-POBUW70-60	660 - 718			
WG-POBUW80-60	760 - 818			
WG-POBUW90-60	860 - 918			

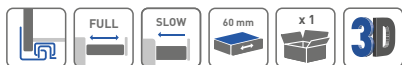

Zásuvka ELITE na obuv kovová  
 Zásuvka ELITE na obuv kovová  
 Fém kihúzható cipőtartó ELITE  
 Suport pentru pantofi extensibil metalic ELITE

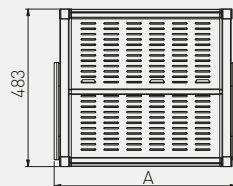

A  
min./max.







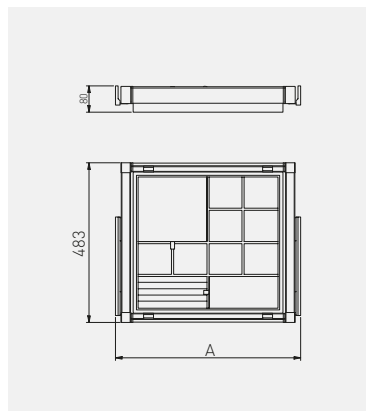

WG-POBUWM60-10	560 - 618	úplný úplný teljes complet	bílám biela fehér alb	ocel + plast, ocel + plast, acél + műanyag, oțel + plastic
WG-POBUWM70-10	660 - 718			
WG-POBUWM80-10	760 - 818			
WG-POBUWM90-10	860 - 918			
WG-POBUWM60-60	560 - 618		antracitová, antracitová, antracit, antracit	
WG-POBUWM70-60	660 - 718			
WG-POBUWM80-60	760 - 818			
WG-POBUWM90-60	860 - 918			



Zásuvka ELITE s organizérem  
 Zásuvka ELITE s organizérom  
 Rendező ELITE  
 Organizator ELITE



	A min./max.			
WG-PRZEG60-10	560 – 618			
WG-PRZEG70-10	660 – 718			
WG-PRZEG80-10	760 – 818			
WG-PRZEG90-10	860 – 918			
WG-PRZEG60-60	560 – 618			
WG-PRZEG70-60	660 – 718			
WG-PRZEG80-60	760 – 818			
WG-PRZEG90-60	860 – 918			
			antracitová, antracitová, antracit, antracit	

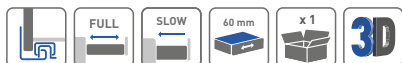

Zásuvka ELITE na kalhoty  
Zásuvka ELITE na nohavice  
Nadrágtartó ELITE  
Suport pentru pantaloni ELITE

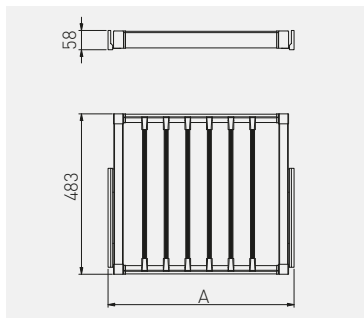

	A			
	min./max.			
WG-WSP0D60-10	560 – 618	úplný úplný teljes complet		
WG-WSP0D70-10	660 – 718			
WG-WSP0D80-10	760 – 818			
WG-WSP0D90-10	860 – 918			
WG-WSP0D60-60	560 – 618			
WG-WSP0D70-60	660 – 718			
WG-WSP0D80-60	760 – 818			
WG-WSP0D90-60	860 – 918			

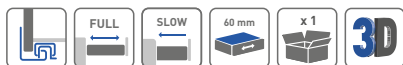

Zásuvkový nosník ELITE  
Zásuvkový nosník ELITE  
Gerenda ELITE fiókhhoz  
Bară de sertar ELITE

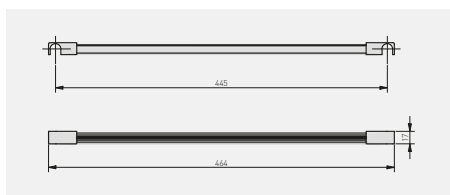

	počet drátů počet drôtov drótok száma număr de fire	přídavný nosník přídavný nosník kiegészítő gerenda bară suplimentară	
WG-WSP0D60	6	WG-WSP0D-BAR-10 WG-WSP0D-BAR-60	
WG-WSP0D70	7		
WG-WSP0D80	8		
WG-WSP0D90	9		

Hranatá šatní tyč s držáky  
 Hranatá šatníková tyč s držiakmi  
 Téglalap alakú szekréynysín foglalattal  
 Șină de garderobă dreptunghiulară cu priză

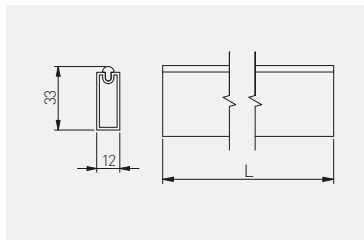





	  L mm		
WG-RRPSET-A-10	3000	bílá / biela / fehéř / alb	hliník + plast hliník + plast aluminium + műanyag aluminium + plastic
WG-RRPSET-B-10			
WG-RRPSET-A-60		antracitová / antracitová / antracit / antracit	
WG-RRPSET-B-60			

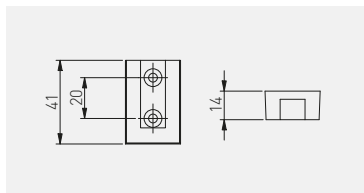

Držáky hranaté šatní tyče  
 Držiaky hranatej šatníkovej tyče  
 Téglalap alakú szekréynysín foglalát  
 Soclu dreptunghiular pentru șifonier



	 		
WG-RDRP-10	držák hranaté tyče uzavřený držiak hranatej šatníkovej tyče uzavretý téglalap alakú szekréynysín foglalát végzáróval Bară haïne dreptunghiular pentru șifonier cu capete	bílá / biela / fehéř / alb	ZnAl + plast, ZnAl + plast, ZnAl + műanyag, ZnAl + plastic
WG-RDRP-60		antracitová / antracitová / antracit / antracit	
WG-RDRO-10	držák hranaté tyče otevřený držiak hranatej šatníkovej tyče otvorený téglalap alakú szekréynysín foglalát végzáró nélkül soclu dreptunghiular pentru șifonier fără capete	bílá / biela / fehéř / alb	ZnAl
WG-RDRO-60		antracitová / antracitová / antracit / antracit	



Sklopná šatná tyč s olejovým pístem  
 Pantograf s olejovým piestom  
 Lehúžható szekréynsín - olaj  
 Şinã de garderobã pliantã - ulei

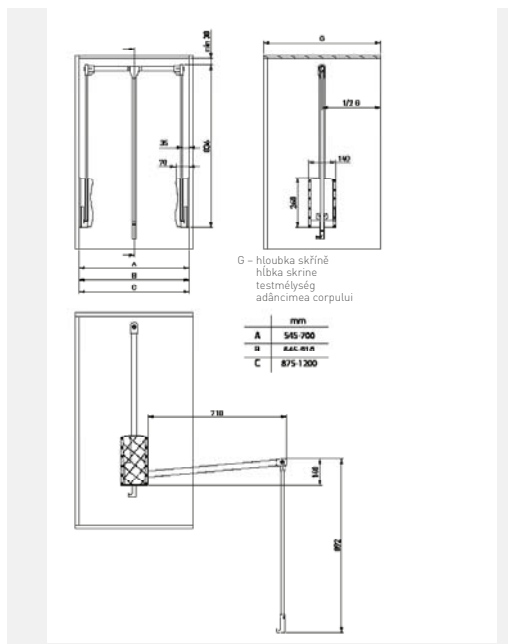

PG-ST83115-10A	875 - 1200	8	bílãm biela fehér alb	ocel ocel acel oțel
PG-ST6083-10A	645 - 910			
PG-ST4560-10A	545 - 700			
PG-ST83115-60	875 - 1200		antracitovã, antracitovã, antracit, antracit	
PG-ST6083-60	645 - 910			
PG-ST4560-60	545 - 700			









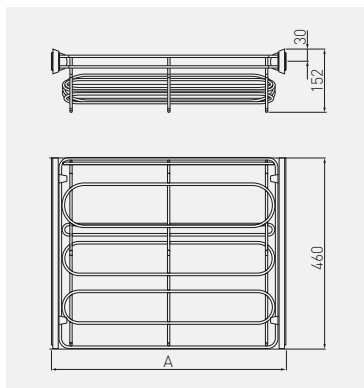



Zásuvka SMART na obuv  
 Zásuvka SMART na obuv  
 Cipőtartó SMART kihuzható  
 Suportul pentru pantofi SMART extensibil



W-W0BU60-BP-60	sada bez výsuvů súprava bez výsuvov sín nélküli készlet set fărã sine	600		560 - 568		
W-W0BU70-BP-60	sada bez výsuvů súprava bez výsuvov sín nélküli készlet set fărã sine	700		660 - 668		
W-W0BU80-BP-60	sada bez výsuvů súprava bez výsuvov sín nélküli készlet set fărã sine	800	úplný úplný teljes complet	760 - 768	šedá, sivá, szürke, gri	ocel + plast, ocel + plast, acél + műanyag, oțel + plastic
W-W0BU90-BP-60	sada bez výsuvů súprava bez výsuvov sín nélküli készlet set fărã sine	900		860 - 868		





				 mm		A min./max.		
W-WOBU60-BP-10	sada bez výsuvů súprava bez výsuvov sin nélkülű készlet set fără sine			600		560 – 568		
W-WOBU70-BP-10	sada bez výsuvů súprava bez výsuvov sin nélkülű készlet set fără sine			700		660 – 668		
W-WOBU80-BP-10	sada bez výsuvů súprava bez výsuvov sin nélkülű készlet set fără sine			800	úplný úplný teljes complet	760 – 768	bílám biela fehér alb	ocel + plast, ocel + plast, acél + műanyag, oțel + plastic
W-WOBU90-BP-10	sada bez výsuvů súprava bez výsuvov sin nélkülű készlet set fără sine			900		860 – 868		

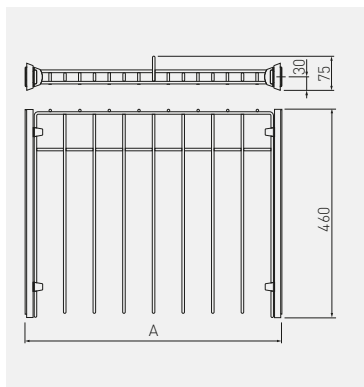

SMART skříňový věšák na kalhoty  
 SMART skříňový vešiak na nohavice  
 Nadrágtartó SMART  
 Suport pentru pantaloni SMART



				A		
W-WSPD60-BP-60	sada bez výsuvů súprava bez výsuvov sín nélküli készlet set fără sine	600		560 – 568		
W-WSPD70-BP-60	sada bez výsuvů súprava bez výsuvov sín nélküli készlet set fără sine	700		660 – 668		
W-WSPD80-BP-60	sada bez výsuvů súprava bez výsuvov sín nélküli készlet set fără sine	800	úplný úplný teljes complet	760 – 768	šedá, sivá, szürke, gri	ocel + plast, ocel + plast, acél + műanyag, oțel + plastic
W-WSPD90-BP-60	sada bez výsuvů súprava bez výsuvov sín nélküli készlet set fără sine	900		860 – 868		





min



A  
min./max.





W-WSPD60-BP-10	sada bez výsuvů súprava bez výsuvov sín nélküli készlet set fără sine	600		560 – 568		
W-WSPD70-BP-10	sada bez výsuvů súprava bez výsuvov sín nélküli készlet set fără sine	700		660 – 668		
W-WSPD80-BP-10	sada bez výsuvů súprava bez výsuvov sín nélküli készlet set fără sine	800	úplný úplný teljes complet	760 – 768	biélám biela fehér alb	ocel + plast, ocel + plast, acél + műanyag, oțel + plastic
W-WSPD90-BP-10	sada bez výsuvů súprava bez výsuvov sín nélküli készlet set fără sine	900		860 – 868		

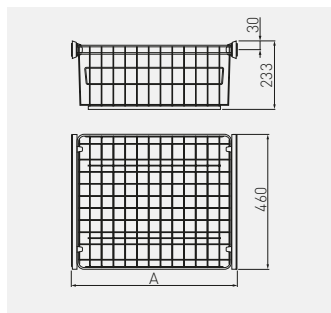

Koš SMART na prádlo  
 Kôš SMART na bielizeň  
 Szekrénykosár SMART  
 Cos de garderoba SMART



				A min./max.	
W-WK060-BP-60	sada bez výsuvů súprava bez výsuvov sín nélküli készlet set fără sine	600		560 - 568	
W-WK070-BP-60	sada bez výsuvů súprava bez výsuvov sín nélküli készlet set fără sine	700		660 - 668	
W-WK080-BP-60	sada bez výsuvů súprava bez výsuvov sín nélküli készlet set fără sine	800	úplný úplný teljes complet	760 - 768	šedá, sivá, szürke, gri
W-WK090-BP-60	sada bez výsuvů súprava bez výsuvov sín nélküli készlet set fără sine	900		860 - 868	ocel + plast, ocel + plast, acél + műanyag, oțel + plastic







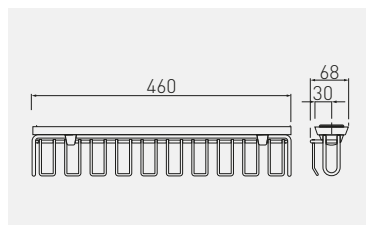

 A  
min./max.

		mm		A min./max.		
W-WK060-BP-10	sada bez výsuvů súprava bez výsuvov sín nĕlkŭli kĕszlet set fără sine	600		560 – 568		
W-WK070-BP-10	sada bez výsuvů súprava bez výsuvov sín nĕlkŭli kĕszlet set fără sine	700		660 – 668		
W-WK080-BP-10	sada bez výsuvů súprava bez výsuvov sín nĕlkŭli kĕszlet set fără sine	800	ŭplnŭy ŭplnŭy teljes complet	760 – 768	bĭlám biela fehér alb	ocel + plast, ocel + plast, acĕl + mŭanyag, oțel + plastic
W-WK090-BP-10	sada bez výsuvů súprava bez výsuvov sín nĕlkŭli kĕszlet set fără sine	900		860 – 868		



Věšák SMART na pásky a kravaty  
 Vešiak SMART na opasky a viazanky  
 Őv és nyakkendő tartó SMART  
 Suport curea si cravata SMART











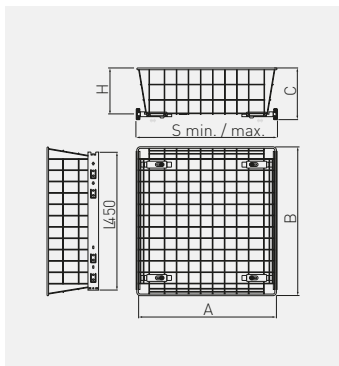

				
W-WKRP-BP-60	sada bez výsuvů súprava bez výsuvov sín nélkülű készlet set fără sine	úplný úplný teljes complet	šedá, sivá, szürke, gri	ocel + plast, ocel + plast, acél + műanyag, oțel + plastic
W-WKRP-VE-60	na kuličkovém výsuvu H45 s pomalým zavíráním na guľôčkovom výsuvu H45 s pomalým zatváraním fékes H45 golyós fióksinen pe rulmentul cu bile H45 cu amortizare			
W-WKRP-BP-10	sada bez výsuvů súprava bez výsuvov sín nélkülű készlet set fără sine		білім біела fehér alb	
W-WKRP-VE-10	na kuličkovém výsuvu H45 s pomalým zavíráním na guľôčkovom výsuvu H45 s pomalým zatváraním fékes H45 golyós fióksinen pe rulmentul cu bile H45 cu amortizare			





Šatní koš na kuličkovém výsuvu H35\*  
 Šatníkový kôš na guľičkovom výsuvu H35\*  
 Szekrénykosár H35 golyós sinnel\*  
 Coș de garderobă pe glisieră cu bile H35\*



	 H mm	 mm	 A mm	 B mm	 C mm	 S min/max			
KO-SR100-30-10	300	100	255	485	123	260-285	pozinkovaný pozinkovaný galvanizált galvanizát	bílám biela fehér alb	ocel + plast, ocel + plast, acél + műan- yag, oțel + plastic
KO-SR100-40-10	400	100	355	485	123	360-385			
KO-SR100-50-10t	500	100	455	485	123	460-485			
KO-SR100-60-10	600	100	555	485	123	560-585			
KO-SR150-30-10	300	150	255	485	173	260-285			
KO-SR150-40-10	400	150	355	485	173	360-385			
KO-SR150-50-10	500	150	455	485	173	460-485			
KO-SR150-60-10	600	150	555	485	173	560-585			
KO-SR200-30-10	300	200	255	485	223	260-285			
KO-SR200-40-10	400	200	355	485	223	360-385			
KO-SR200-50-10	500	200	455	485	223	460-485			
KO-SR200-60-10	600	200	555	485	223	560-585			



Produkt pro montáž na vedení H35, H45 a válečkovém vedení – sada bez vedení  
 Produkt pre montáž na vedení H35, H45 a valčekovom vedení – sada bez vedenia  
 H35, H45 és görgős csúszdákra szerelhető termék – készlet vezetőelem nélkül  
 Produs pentru a fi montat pe glisieră H35, H45 și glisierăle cu role – set fără glisieră



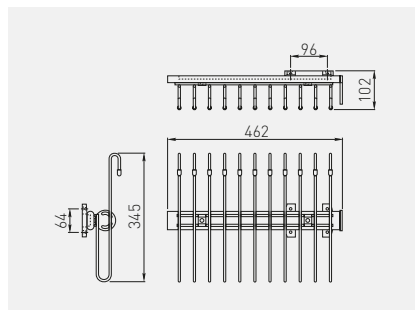

Věšák WS na kalhoty  
Vešniak WS na nohavice  
Kihúzható nadrágtartó  
Suport pentru pantaloni extensibil

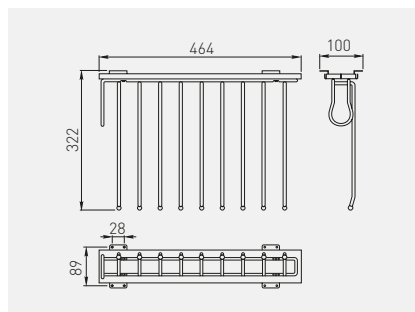

			
WW-WSP00-01	částečný častočný részleges parťial	chrom, hliník, černá chróm, hliník, čierna króm, aluminium, fekete crom, aluminiu, negru	ocel, hliník, plast ocel, hliník, plast acél-, aluminium, műanyag oțel, aluminiu, plastic

Věšák WS na kalhoty  
Vešniak WS na nohavice  
Nadrágtartó WS  
Suport pantaloni WS



				
WW-WSP000-01	pravé, pravý, jobb, dreapta	částečný častočný részleges parťial	chrom, hliník, černá chróm, hliník, čierna króm, aluminium, fekete crom, aluminiu, negru	ocel, hliník, plast ocel, hliník, plast acél-, aluminium, műanyag oțel, aluminiu, plastic
WW-WSL000-01	levý lavý bal stânga			

Věšák WU na oblečení  
 Vešiak WU na oblečenie  
 Ruhafogas WU  
 Suport de îmbrăcăminte WU

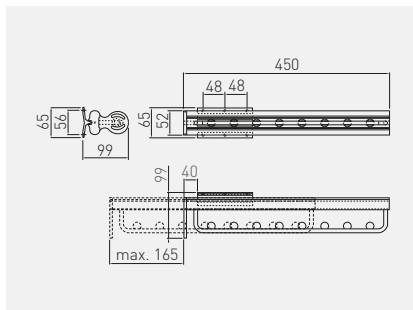

WW-WUBR00-01	častečný čiasťočný részleges parťial	chrom, hliník, černá chróm, hliník, čierna króm, aluminium, fekete crom, aluminium, negru	ocel, hliník, plast ocel, hliník, plast acél-, aluminium, műanyag oțel, aluminium, plastic





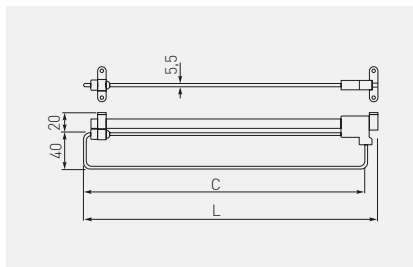



Výsuvný věšák WSL  
 Výsuvný vešiak WSL  
 Fogas WSL  
 Suport umerase WSL

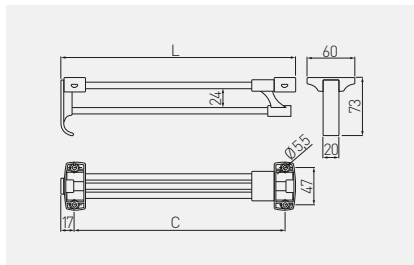

		C mm	L mm		
WW-WSL250-01		235	250	chrom chróm króm crom	ocel ocel acél oțel
WW-WSL300-01		285	300		
WW-WSL350-01		335	350		
WW-WSL400-01		385	400		
WW-WSL450-01		435	450		
WW-WSL500-01		485	500		

Výsuvný věšák WSD  
 Výsuvný vešiak WSD  
 Behúzható fogas WSD  
 Suport umerase extensibil WSD



	 C mm	 L mm		
WW-WSD250-01B	220	252	chrom, černá chróm, čierna króm, fekete crom, negru	ocel + plast, ocel + plast, acél + műanyag, oțel + plastic
WW-WSD300-01B	270	302		
WW-WSD350-01B	320	352		
WW-WSD400-01B	370	402		
WW-WSD450-01B	420	452		
WW-WSD500-01B	470	502		

Sada kování pro výklopný botník - plast  
 Sada kovania pre výklopný botník - plast  
 Pánt cipőtartóhoz  
 Balama pentru suport pantofi

NEW

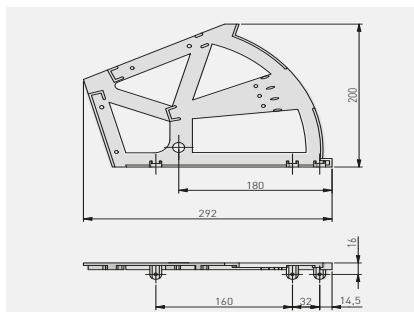







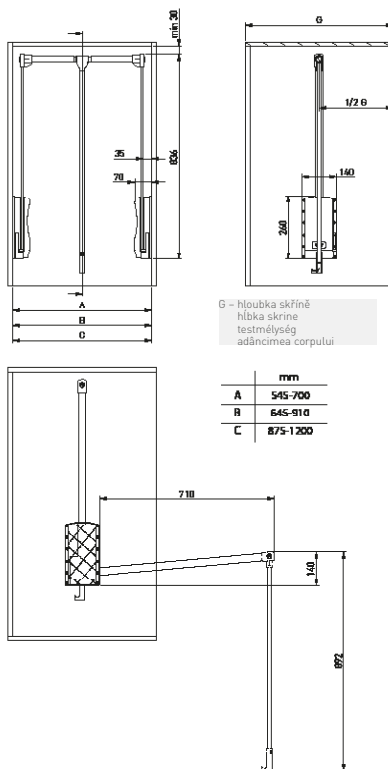

Pro 12 mm desku  
 Pre 12 mm dosku  
 12 mm vastag bútortlaphoz  
 Pentru blat 12 mm

		
WW-ZWBUT2P-10	bílá / biela / fehér / alb	plast, plast, műanyag, plastic
WW-ZWBUT2P-20	černá / čierna / fekete / negru	



Sklopná šatní tyč  
 Sklopná šatníková tyč  
 Pánt cipőtartóhoz  
 Balama pentru suport pantofi







		 mm	 kg			
PG-GA4560-10		545 – 700	12			
PG-GA6083-10		645 – 910				
PG-GA83115-10		875 – 1200				
PG-GA4560-20		545 – 700				
PG-GA6083-20		645 – 910				
PG-GA8311520		875 – 1200				
					bílám biela fehér alb	ocel + plast, oţel + plast, acél + műanyag, oţel + plastic
					černá čierná fekete negru	

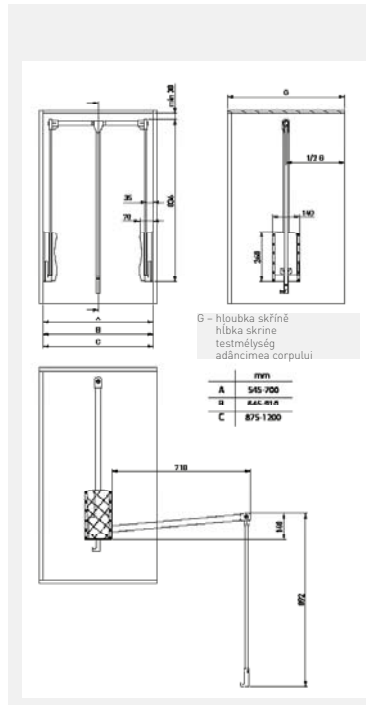

Sklopná šatní tyč s olejovým tlumičem  
 Sklopná šatníková tyč s olejovým tlmičom  
 Lehúzható szekréynysín - olaj  
 Şinã de garderobã pliantã - ulei



		 mm	 kg		
PG-AL4560-20		545 – 700	8	hliník / hliník / aluminiòm / aluminiu	hliník + plast hliník + plast aluminiòm + múanyag aluminium + plastic
PG-AL6083-20		645 – 910			
PG-AL8311520		875 – 1200			
PG-ST4560-10		545 – 700		bílã / biela / fehér / alb	ocel + plast. ocel + plast. acél + múanyag, oțel + plastic
PG-ST4560-20				černã / čierna / fekete / negru	
PG-ST6083-10		645 – 910		bílã / biela / fehér / alb	
PG-ST6083-20				černã / čierna / fekete / negru	
PG-ST83115-10		875 – 1200		bílã / biela / fehér / alb	
PG-ST8311520			černã / čierna / fekete / negru		





Odpadkový koš PRACTI ECO 400  
 Odpadkový kôš PRACTI ECO 400  
 Szemetes PRACTI ECO 400  
 Coș de gunoi PRACTI ECO 400

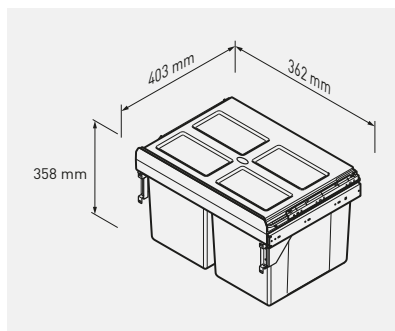

PB-45-400MF-2X16-60A

400

2 x 16 L

antracitová,  
 antracitová,  
 antracit,  
 antracit

plast / plast / műanyag / plastic





Odpadkový koš PRACTI ECO 300  
 Odpadkový kôš PRACTI ECO 300  
 Szemetes PRACTI ECO 300  
 Coș de gunoi PRACTI ECO 300



PB-45-0010X3-60A



PB-45-002010-60A

Na kuličkovém výsuvu H45 s pomalým zavíráním  
 Na guľičkovom výsuvu H45 s pomalým zatváraním  
 A H45 golyóscsapágy csúszósín, puha záródással  
 Gisant pe rulment cu bile H45 cu închidere ușoară

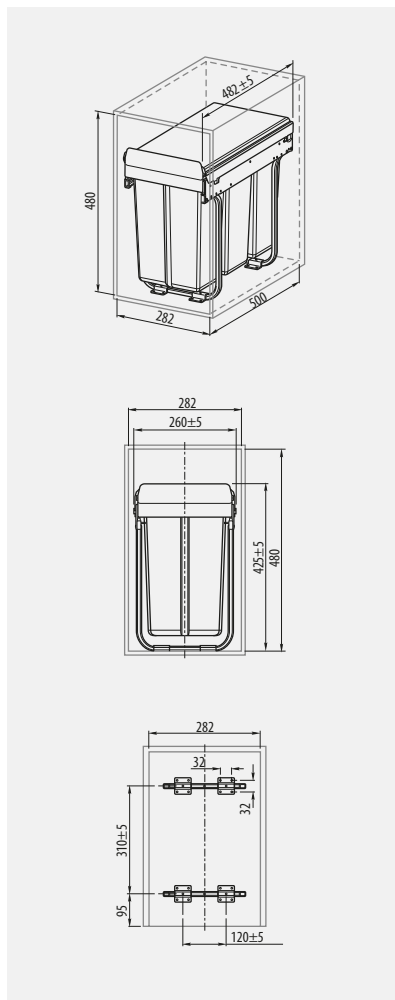

					
PB-45-0010X3-60A	300	3 x 10 L	antracitová, antracitová, antracit, antracit	plast / plast / műanyag / plastic	
PB-45-002010-60A	300	10 L, 20 L			



Odpadkový koš PRACTI ECO 400  
 Odpadkový kôš PRACTI ECO 400  
 Szemetes PRACTI ECO 400  
 Coș de gunoi PRACTI ECO 400









PB-45-002X20-60A

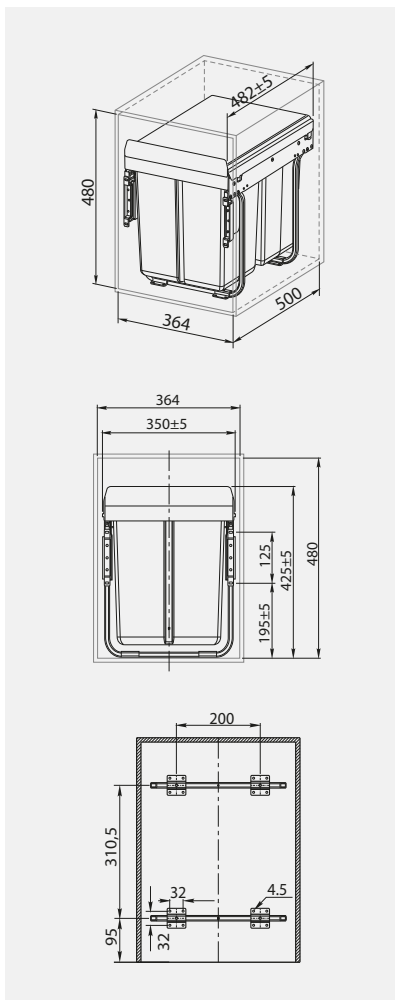

PB-45-202X10-60A

Na kuličkovém výsuvu H45 s pomalým zavíráním  
 Na guľičkovom výsuvu H45 s pomalým zatváraním  
 A H45 golyóscsapágy csúsztósín, puha záródással  
 Glisant pe rulment cu bile H45 cu închidere ușoară



				
PB-45-002X20-60A	400	2 x 20 L	antracitová, antracitová, antracit, antracit	plast / plast / műanyag / plastic
PB-45-202X10-60A	400	20 L, 2 x 10 L		



Odpadkový koš PRACTI ECO 400  
 Odpadkový kôš PRACTI ECO 400 - s predným uchytiením  
 Szemetes PRACTI ECO 400  
 Coș de gunoi PRACTI ECO 400



PB-45-MF002X20-60A



PB-45-MF202X10-60A

Na kuličkovém výsuvu H45 s pomalým zavíráním  
 Na guľičkovom výsuvu H45 s pomalým zatváraním  
 A H45 golyócsapágy csúszósín, puha záródással  
 Glisant pe rulment cu bile H45 cu închidere ușoară

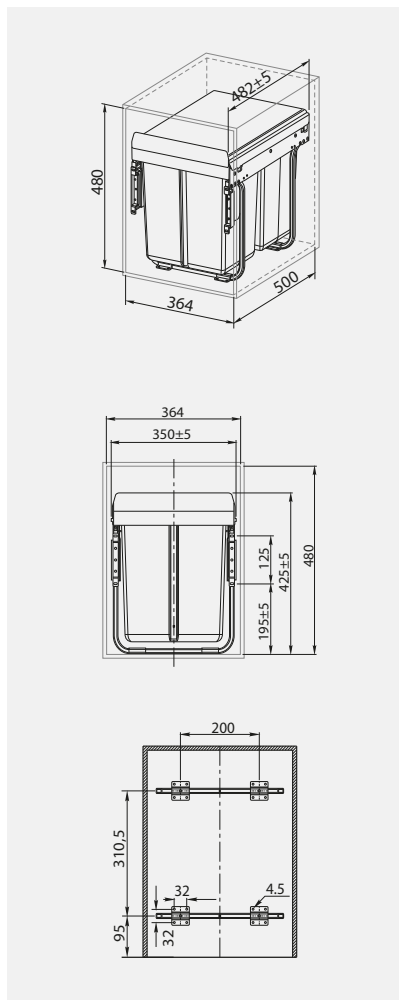

	 mm			
PB-45-MF002X20-60A	400	2 x 20 L	antracitová, antracitová, antracit, antracit	plast / plast / műanyag / plastic
PB-45-MF202X10-60A		20 L, 2 x 10 L		



Odpadkový koš PRACTI ECO 450, nízky  
 Odpadkový kôš PRACTI ECO 450, nízky  
 Szemetes PRACTI ECO 450, alacsony  
 Coș de gunoi PRACTI ECO 450, mic



PB-45-002X15-60A

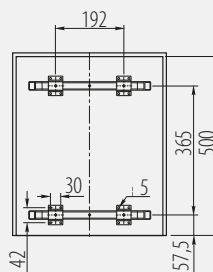
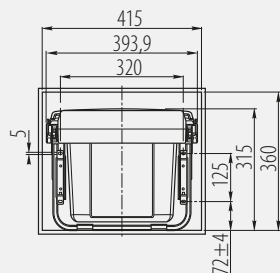
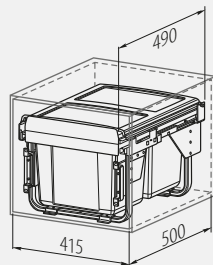

Na výsuvu s pomalým zavíráním  
 Na výsuvu s pomalým zatváraním  
 Fékés fióksinen  
 Sina cu amortizare



PB-45-002X15-60A	450	2 x 15 L	antracitová, antracitová, antracit, antracit	plast / plast / műanyag / plastic
------------------	-----	----------	---	-----------------------------------



Odpadkový koš PRACTI ECO 450, nízky s držákom pro montáž na dvířka  
 Odpadkový kôš PRACTI ECO 450, nízky s držiakom pre montáž na dverka  
 Szemetes PRACTI ECO 450 ajtótartóval  
 Coș de gunoi PRACTI ECO 450 mic cu suport de montare pe ușă



PB-45-MF2X15-60A

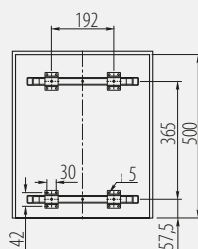
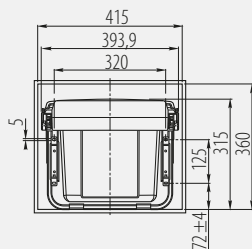
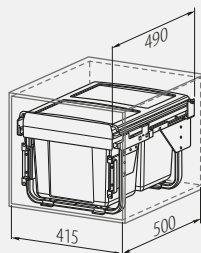

Na výsuvu s pomalým zavíráním  
 Na výsuvu s pomalým zatváraním  
 Fékés fióksinen  
 Sina cu amortizare



PB-45-MF2X15-60A	450	2 x 15 L	antracitová, antracitová, antracit, antracit	plast / plast / műanyag / plastic
------------------	-----	----------	---	-----------------------------------



Odpadkový koš PRACTI ECO 450, vysoký  
 Odpadkový kôš PRACTI ECO 450, vysoký  
 Szemetes PRACTI ECO 450 magas  
 Coș de gunoi PRACTI ECO 450 înalt



PB-45-450-2X20-60A



PB-45-0202X10-60A

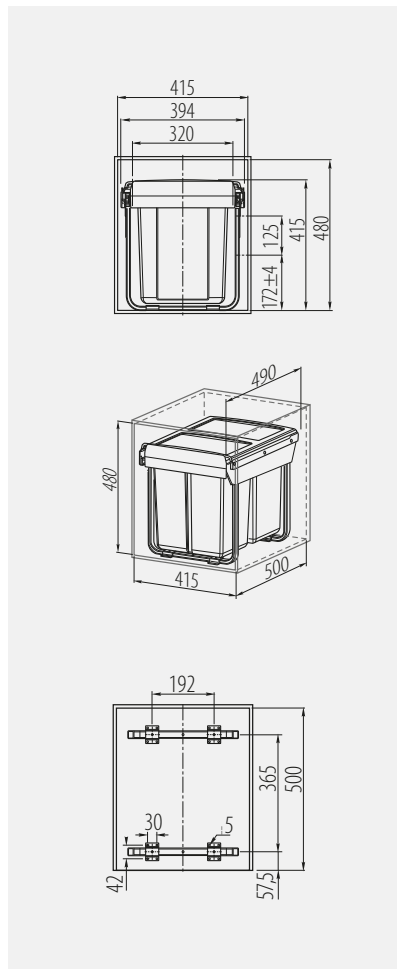

Na výsuvu s pomalým zavíráním  
 Na výsuvu s pomalým zatváraním  
 Fékés fióksinen  
 Sina cu amortizare



PB-45-450-2X20-60A	450	2 x 20 L	antracitová, antracitová, antracit, antracit	plast / plast / műanyag / plastic
PB-45-0202X10-60A		20 L, 2 x 10 L		



Odpadkový koš PRACTI ECO 450, vysoký s držákem pro montáž na dvířka  
 Odpadkový koš PRACTI ECO 450, vysoký s držiakom pre montáž na dvierka  
 Szemetes kuka PRACTI ECO 450 magasságu, ajtóra rögzítő  
 Cos de gunoi PRACTI ECO inaltime 450, cu montaj pe usa



PB-45-450MF20X10-60A



PB-45-MF2X20-60A

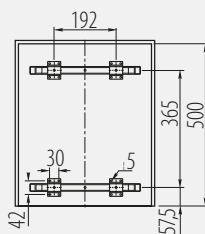
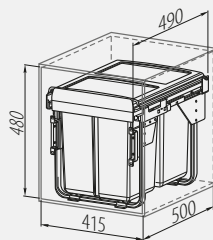
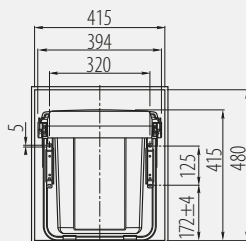

Na výsuvu s pomalým zavíráním  
 Na výsuvu s pomalým zatváraním  
 Fékés fióksinen  
 Sina cu amortizare



PB-45-450MF20X10-60A	450	20 L, 2 x 10 L	antracitová, antracitová, antracit, antracit	plast / plast / műanyag / plastic
PB-45-MF2X20-60A		2 x 20 L		



Odpadkový koš PRACTI ECO 600, vysoký s držákem pro montáž na dvířka  
 Odpadkový koš PRACTI ECO 600, vysoký s držákem pro montáž na dvířka  
 Szemetes kuka PRACTI ECO 600 magasságu, ajtóra rögzítő  
 Cos de gunoi PRACTI ECO inaltime 600, cu montaj pe usa



PB-45-MF342X17-60A



PB-45-MF2X34-60A

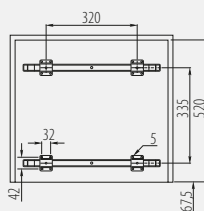
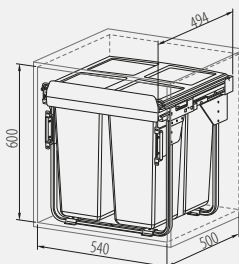
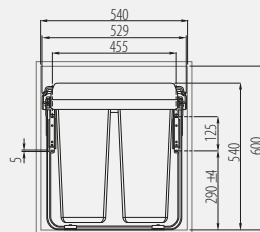

Na výsuvu s pomalým zavíráním  
 Na výsuvu s pomalým zatváraním  
 Fékés fióksinen  
 Sina cu amortizare



PB-45-MF342X17-60A	600	34 L, 2 x 17 L	antracitová, antracitová, antracit, antracit	plast / plast / műanyag / plastic
PB-45-MF2X34-60A		2 x 34 L		





Odpadkový koš PRACTI ECO 600  
 Odpadkový kôš PRACTI ECO 600, nízky s predným uchytiením  
 Szemetes PRACTI ECO 600  
 Coș de gunoi PRACTI ECO 600

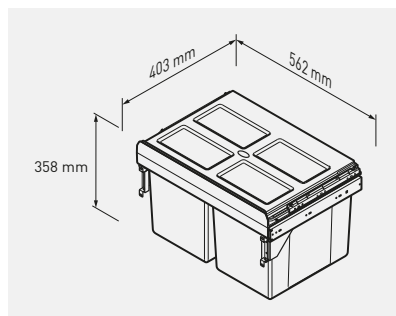

PB-45-600MF-2X27-60A

600

2 x 27 L





antracitová,  
 antracitová,  
 antracit,  
 antracit

plast / plast / műanyag / plastic



Odpadkový koš AXISPACE  
 Odpadkový kôš AXISPACE  
 Szemetes AXISPACE  
 Coș de gunoi AXISPACE



					
PB-AS-600-1X15L-2X7L		600	1 x 15 L, 2 x 7 L	antracitová, antracitová, antracit, antracit	umělá hmota s částicemi grafénu* plast s částicami grafénu* a graféň rézszeckéket tartalmazó műanyag* plastic cu particule de graféň*
PB-AS-600-1X15L-3X7L			1 x 15 L, 3 x 7 L		
PB-AS-600-2X15L			2 x 15 L		
PB-AS-600-2X15L-2X7L			2 x 15 L, 2 x 7 L		
PB-AS-700-2X15L-2X7L		700	2 x 15 L, 2 x 7 L		
PB-AS-800-2X15L-2X7L			2 x 15 L, 2 x 7 L		
PB-AS-800-4X15L		800	4 x 15 L		
PB-AS-900-4X15L			4 x 15 L		



\*grafen je nanomateriál vyráběný z uhlí s antibakteriálními a protiplísňovými účinky. Je schopen eliminovat ze svého povrchu až 99% mikroorganismů za 120 min.  
 Graféň – nanomateriál vytvorený z uhlíka s antibakteriálnymi a antimykotickými účinkami. Dokáže na svojho povrchu zlikvidovať až 99% mikroorganizmov v priebehu 120 min.  
 A graféň rézszeckéket tartalmazó műanyag egy olyan szén-alapú nano-anyag, amely antimikrobiális és gombaellenes jellemzőkkel rendelkezik. 120 percen belül akár a mikroorganizmusok 99%-át is képes eltávolítani a felületről.  
 Graféňul este un nanomaterial format din carbon cu proprietăți antibac teriene și antifungice. Acesta este capabil să elimine până la 99% din microorganismele de pe suprafața sa în 120 de minute.

Odpadkový koš MULTINO  
 Odpadkový kôš MULTINO  
 Szemetes MULTINO  
 Coș de gunoi MULTINO

Pro zásuvky Modern Box  
 Pre zásuvky Modern Box  
 Modern Box fiókokhoz  
 Pentru sertarele Modern Box

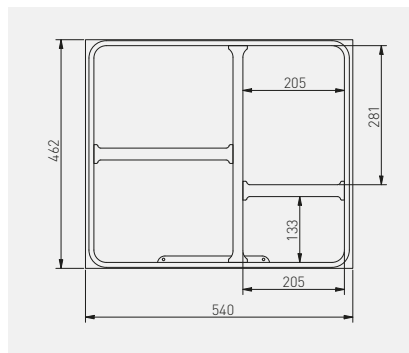

PB-93004162601	540	3 x 15 L, 1 x 7 L	antracitová, antracitová, antracit, antracit	plast, plast, műanyag, plastic



Koš CIRCA  
 Kôš CIRCA  
 Szemetes CIRCA  
 Coș de gunoi CIRCA

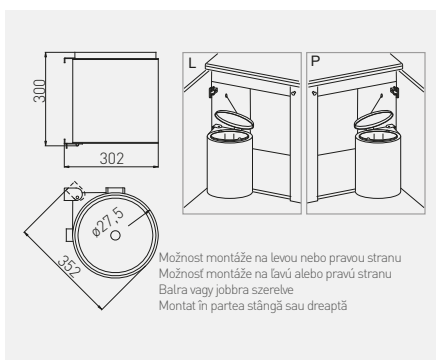

PB-91024160V	11 L	šedá / sivá / szürke / gri	plast / plast / műanyag / plastic



VÝSUVNÝ CORNER MOVIXPRO 450  
 VÝSUVNÝ CORNER MOVIXPRO 450  
 MOVIXPRO 450 KIHÚZHATÓ SAROK  
 CORNER CU EXTRAGERE MOVIXPRO 450

NEW

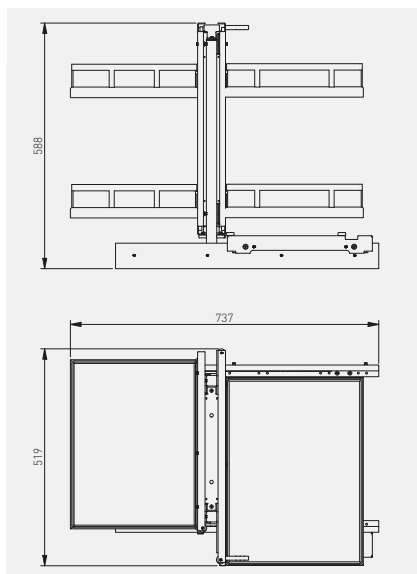

	mm		
KO-WMC450-60	450	antracitová, antracitová, antracit, antracit	ocel ocel acél oțel
KO-WMC450-01B		cchrom + matná bílá, chróm + matná biela, króm + fehér anyag, crom + alb mat	
KO-WMC450-01		chrom + matný atracit, chróm + matný antracit, króm + antracit anyag, crom + mat antracit	
KO-WMC500-60	500	antracitová, antracitová, antracit, antracit	
KO-WMC500-01B		cchrom + matná bílá, chróm + matná biela, króm + fehér anyag, crom + alb mat	
KO-WMC500-01		chrom + matný atracit, chróm + matný antracit, króm + antracit anyag, crom + mat antracit	



VÝKLOPNÝ CORNER MOVIXPRO 450  
 VÝKLOPNÝ CORNER MOVIXPRO 450  
 MOVIXPRO 450 DÖNTHETŐ SAROK  
 CORNER ÎNCLINABIL MOVIXPRO 450

NEW

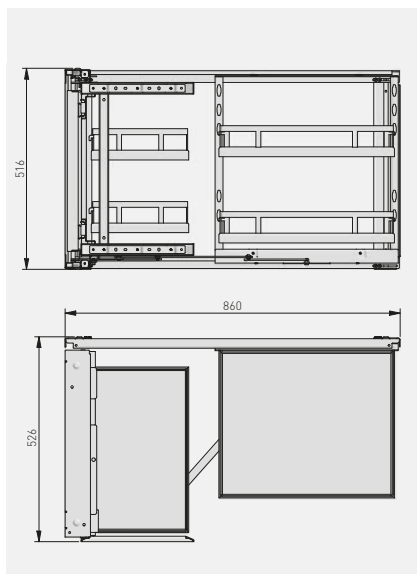







KO-UMC450-60	antracitová, antracitová, antracit, antracit	ocel ocel ocel ocel
KO-UMC450-01B	cchrom + matná bílá, chróm + matná biela, króm + fehé anyag, crom + alb mat	
KO-UMC450-01	antracitová, antracitová, antracit, antracit	

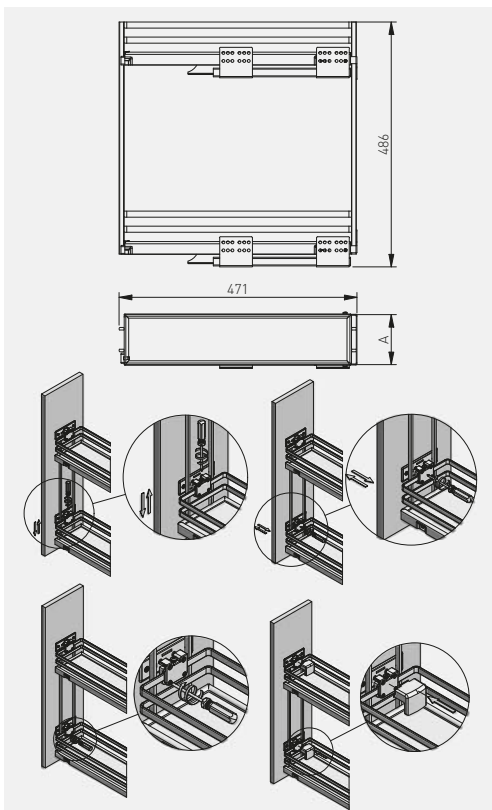

Boční koš cargo Movix Pro s pomalým zavíráním  
 Bočný kôš cargo Movix Pro s pomalým zatváraním  
 Oldalra rögzítõ kosár Movix Pro csillapított zárással  
 Cos cargo lateral Movix Pro cu amortizare

NEW



	 mm			
KO-150BO-60	150	pozinkovaný pozinkovaný galvanizált galvanizát	antracitová, antracitová, antracit, antracit	ocel ocel acél oţel
KO-200BO-60	200			
KO-150BO-01	150			
KO-200BO-01	200			
KO-150BO-01B	150			
KO-200BO-01B	200			
			chrom + matný atracit, chróm + matný antracit, króm + antracit anyag, crom + mat antracit	
			cchrom + matná bílá, chróm + matná biela, króm + fehér anyag, crom + alb mat	



\* Výrobek neobsahuje vedení.  
 Doplnkové produkty: pro velikosti skříněk 150, 200 mm - vedení s tichým zavíráním PB-KO450BO-L1/PB-KO450BO-R1.  
 \* Výrobek neobsahuje vedení.  
 Doplnkové produkty: pre veľkosti skriniek 150, 200 mm - vedenie s tichým zatváraním PB-KO450BO-L1/PB-KO450BO-R1  
 \* A termék nem tartalmaz vezetőelemeket.  
 Kiegészítő termékek: 150, 200 mm-es szekrényméretekhez - PB-KO450BO-L1/PB-KO450BO-R1 hangtalanul záródó vezetőelem.  
 \* Produsul nu conţine ghidaje.  
 Produse complementare: pentru dulapurile de 150, 200 mm - glisiere cu închidere silenţioasă PB-KO450BO-L1/PB-KO450BO-R1



Boční koš cargo Movix Pro s pomalým zavíráním  
 Bočný kôš cargo Movix Pro s pomalým zatváraním  
 Oldalra rögzítô kosár Movix Pro csillapított zárással  
 Cos cargo lateral Movix Pro cu amortizare

NEW

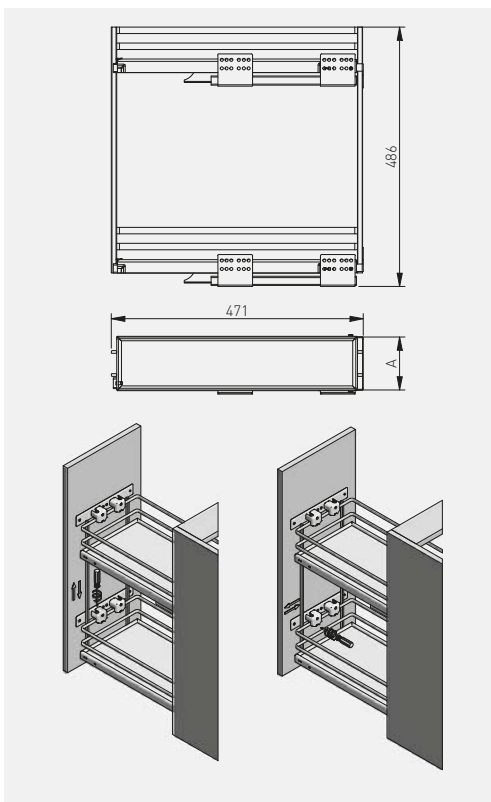

	 mm			
KO-300BO-60	300	pozinkovaný pozinkovaný galvanizált galvanizát	antracitová, antracitová, antracit, antracit	ocel ocel acél oțel
KO-400BO-60	400			
KO-500BO-60	500			
KO-300BO-01	300			
KO-400BO-01	400			
KO-500BO-01	500			
KO-300BO-01B	300			
KO-400BO-01B	400			
KO-500BO-01B	500			
			chrom + matná atracit, chróm + matná antracit, króm + antracit anyag, crom + mat antracit	
			cchrom + matná bílá, chróm + matná biela, króm + fehér anyag, crom + alb mat	







- \* Výrobek neobsahuje vedení.
- \* Doplnkové produkty: pro velikosti skříněk 300, 400, 500 mm - vedení s tichým zavíráním PB-KO450BO.
- \* Výrobek neobsahuje vedení.
- \* Doplnkové produkty: pre veľkosti skriniek 300, 400, 500 mm - vedenie s tichým zatváraním PB-KO450BO.
- \* A termék nem tartalmaz vezetôlemekeket.
- \* Kiegészítô termékek: 300, 400, 500 mm-es szekrényméretekhez - PB-KO450BO hangtalanul záródó vezetôlemez.
- \* Produsul nu conține ghidaje.
- \* Produse complementare: pentru dulapurile de 300, 400, 500 mm - glisiere cu închidere silențioasă PB-KO450BO

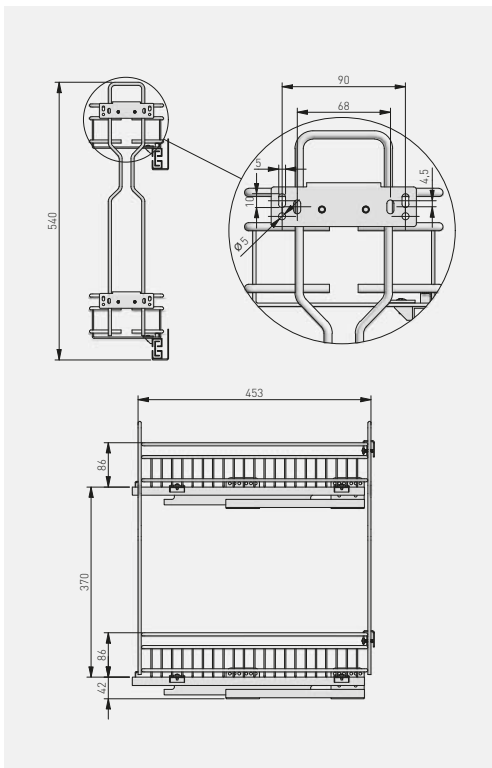
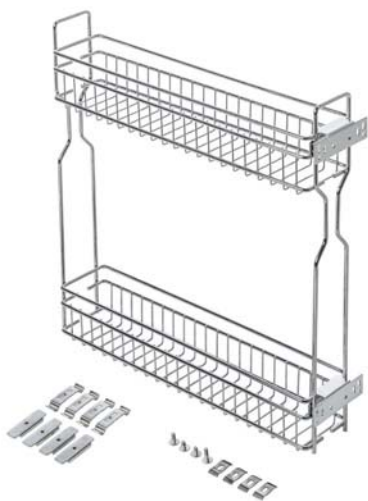

Boční koš cargo Movix s pomalým zavíráním  
 Bočný kôš cargo Movix s pomalým zatváraním  
 Oldalra rögzítő kosár Movix csillapított zárással  
 Cos cargo lateral Movix cu amortizare

NEW



	 		
KO-150BO-E-01	150	chrom chróm króm crom	ocel océl acél oțel
KO-200BO-E-01	200		



\* Výrobek neobsahuje vedení.

\* Doplnkové produkty: vedenie s tichým zavíraním PB-KO450BO-E-L PB-KO450BO-E-R.

\* Výrobek neobsahuje vedenie.

\* Doplnkové produkty: vedenie s tichým zatváraním PB-KO450BO-E-L PB-KO450BO-E-R.

\* A termék nem tartalmaz vezetőelemeket.





\* Kiegészítő termékek: PB-KO450BO-E-L PB-KO450BO-E-R hangtalanul záródó vezetőelem.

\* Produsul nu conține ghidaje.

\* Produse complementare: glisiere cu închidere silențioasă PB-KO450BO-E-L PB-KO450BO-E-R.

Výsuv s tlumením pro Cargo Movix Pro 150 a 200  
 Výsuv s tlmením pre Cargo Movix Pro 150 a 200  
 Lágyan záródó csúsztósínek Cargo Movix Pro 150 és 200 típusokhoz  
 Glisiere cu închidere moale pentru Cargo Movix Pro 150 și 200



			
PB-K0450BO-L1	x2	chrom chróm króm crom	ocel ocet acél oțel
PB-K0450BO-R1	x2		

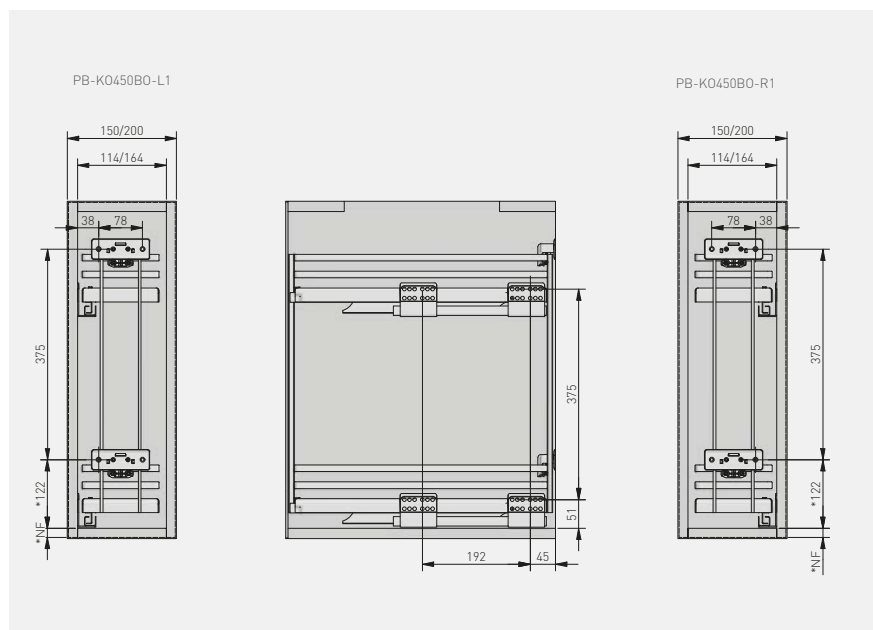

Výsuv s tlumením pro Cargo Movix Pro 300, 400 a 500

Výsuv s tlmením pre Cargo Movix Pro 300, 400 a 500

Lágyan záródó csúszósínek Cargo Movix PRO 300, 400 és 200 típusokhoz

Glisiere cu închidere moale pentru Cargo Movix PRO 300, 400 și 200



			
PB-K0450B0	x2	chrom chróm króm crom	ocel ocel acél oțel

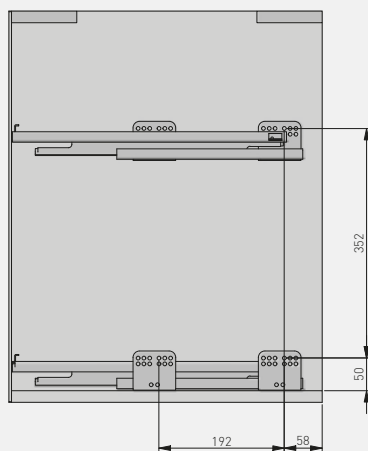
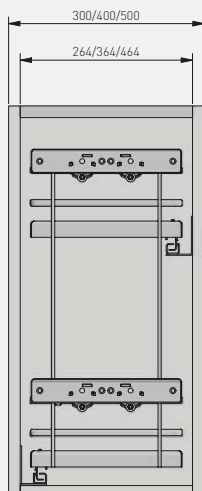

Výsuv s tlumením pro Cargo Movix 150 a 200  
 Výsuv s tlmením pre Cargo Movix 150 a 200  
 Lágyan záródó csúszósínek Cargo Movix 150 és 200 típusokhoz  
 Glisiere cu închidere moale pentru Cargo Movix 150 și 200



PB-K0450B0-E-L	x2	chrom chróm króm crom	ocel ocel acél oțel
PB-K0450B0-E-R	x2		



PB-K0450B0-E-L

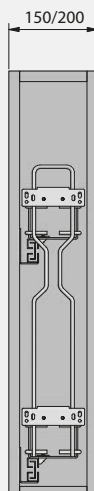

PB-K0450B0-E-R

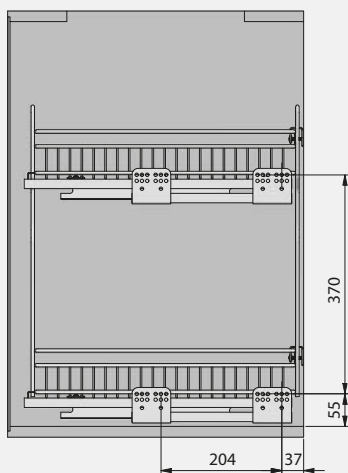
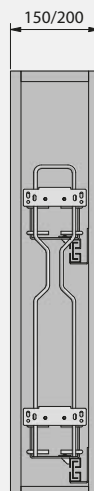

Vestavný odkapávač dvojitý  
 Vstavný odkvapkávač dvojitý  
 Kétszintű edénycsepptető állvány  
 Scurgator de vase cu două niveluri



OC-A0150-06		
OC-A0160-06	kartáčovaná ocel, kartáčovaná ocel, szálcsiszolt acél, oțel periat	nerezová ocel nehrdzavejúca ocel rozsdamentes acél oțel inoxidabil
OC-A0170-06		
OC-A0180-06		
OC-A0190-06		

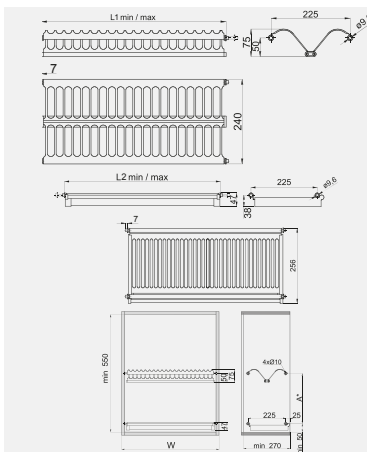

Rožmър A\* závisí na výšce skříně a plánování prostoru (např. A = 275 mm)  
 Rožmър A\* závisí na výšce skříně a plánování prostoru (např. A = 275 mm)  
 A \* мърет а скерънъ магассăгăтőи ř а hely tervezésétől függ (pl. A = 275 mm)  
 Dimensiunea A \* depinde de înălțimea dulapurii și de planificarea spațiului (de ex. A = 275 mm)

L min./max.	W min./max.
430/480	450/475
530/580	550/575
630/680	650/675
730/780	750/775
830/880	850/875

Vestavný odkapávač jednoduchý  
 Vstavný odkvapkávač jednoduchý  
 Edénycsepptető állvány  
 Scurgator de vase





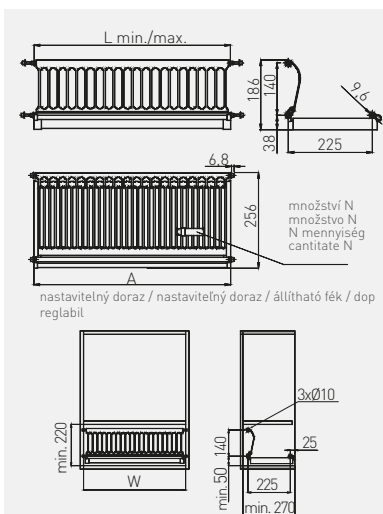



OC-A0660-06	kartáčovaná ocel, kartáčovaná ocel, szálcsiszolt acél, oțel periat	nerezová ocel nehrdzavejúca ocel rozsdamentes acél oțel inoxidabil
OC-A0680-06		

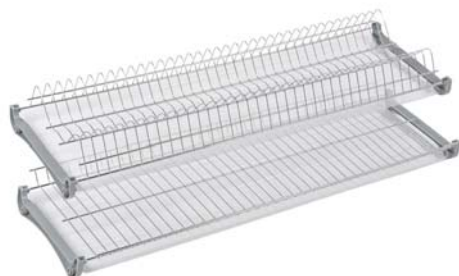

L min./max.	L min./max.	N
530/580	550/575	6
730/780	750/775	8

Vestavný odkapávač dvoupatrový  
 Vstavany odkvapkávač dvojrstvový  
 Kétszintű edénycsepgetető állvány  
 Scurgator de vase cu două niveluri



		 LW mm	 mm		
OC-2PV340-02-18	pro 18 mm desku, pre 18 mm dosku, 18 mm-es táblához, pentru blat de 18 mm	364	400	chrom chróm króm crom	nerezová ocel + plast, nehérszevejező acél + plast, rozsdamentes acél + műanyag, oțel inoxidabil + plastic
OC-2PV345-02-18		414	450		
OC-2PV350-02-18		464	500		
OC-2PV360-02-18		564	600		
OC-2PV360-02-18A*		564	600		
OC-2PV370-02-18		664	700		
OC-2PV380-02-18		764	800		
OC-2PV380-02-18A*		764	800		
OC-2PV390-02-18		864	900		

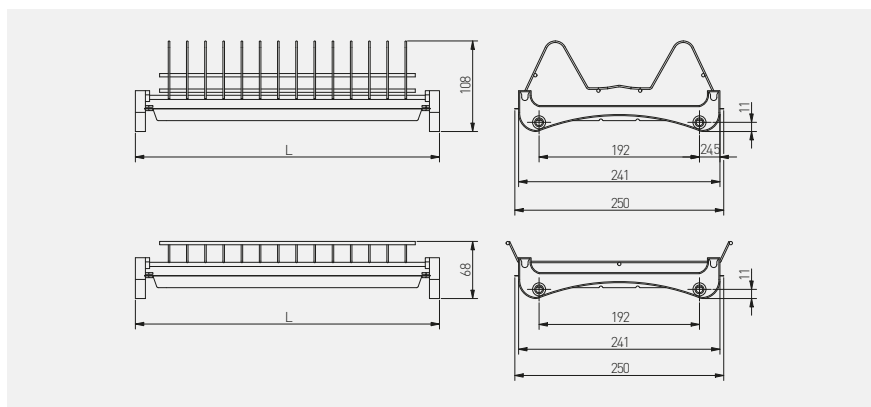



Dvoupatrový odkapávač A04  
 Dvojvrstvý odkvapkávač A04  
 Kétszintű edénycsepgetető állvány A04  
 Scurgator de vase pe doua nivele A04

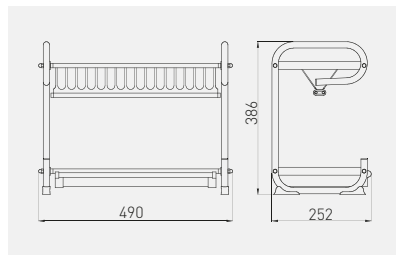

OC-A0450-06

kartáčovaná ocel,  
kartáčovaná ocel,  
szálcsiszolt acél,  
ořel periatnerezová ocel  
nehrdžavejúca ocel  
rozsdamentes acél  
ořel inoxidabil

x 5



Dvoupatrový odkapávač A04  
 Dvojvrstvý odkvapkávač A04  
 Kétszintű edénycsepgetető állvány A04  
 Scurgator de vase pe doua nivele A04

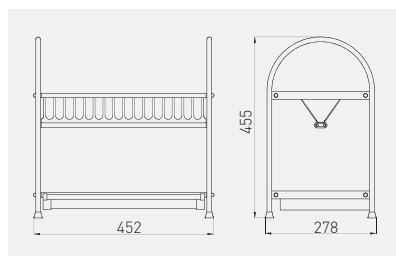

OC-A0350K-06

kartáčovaná ocel,  
kartáčovaná ocel,  
szálcsiszolt acél,  
ořel periatnerezová ocel  
nehrdžavejúca ocel  
rozsdamentes acél  
ořel inoxidabil

x 5





Dvoupatrový odkapávač s příhrádkou na přístroje  
 Dvojvrstvový odkvapkávač s priehradkou na prístroje  
 Kétszintű edénycsepgetető állvány evőeszköz szervezővel  
 Scurgator de vase pe doua nivele cu organizator

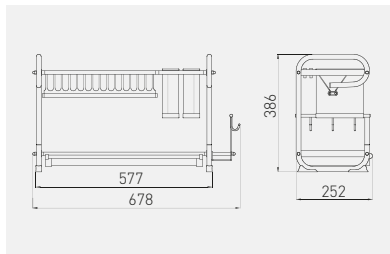

OC-A0460D-06



kartáčovaná ocel,  
 kartáčovaná oceľ,  
 szálcsiszolt acél,  
 oțel periat



nerezová ocel  
 nehrdžavejúca oceľ  
 rozsdamentes acél  
 oțel inoxidabil



Składacý odkapávač  
 Skladací odkvapkávač  
 Összehajtható szárító állvány  
 Scurgator de vase pe doua nivele rulabil

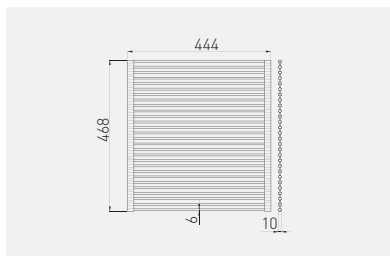

OC-E0707D-CZ



kartáčovaná ocel, černá  
 kartáčovaná oceľ, čierna  
 szálcsiszolt acél, fekete  
 oțel periat, negru



nerezová ocel  
 nehrdžavejúca oceľ  
 rozsdamentes acél  
 oțel inoxidabil



Police na klávesnici s 27 mm výšuvem  
 Polica na klávesnicu s 27 mm výšuvom  
 Klaviatúra tartó 27 mm-es fiókkal  
 Suport tastatură cu glisiera de 27 mm

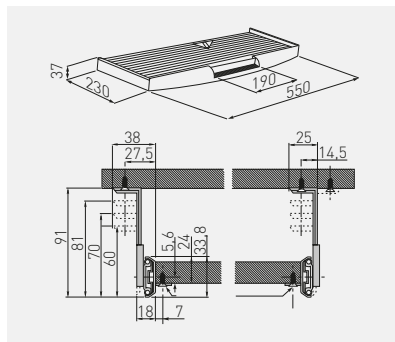

PU-KEY027-20	černá / čierna / fekete / negro	plast plast műanyag plastic
PU-KEY027-60	šedá / sivá / szürke / gri	



Police na klávesnici s podložkou pod myš  
 Polica na klávesnicu s podložkou pod myš  
 Klaviatúra tartó egérpaddal  
 Suport tastatură si mouse

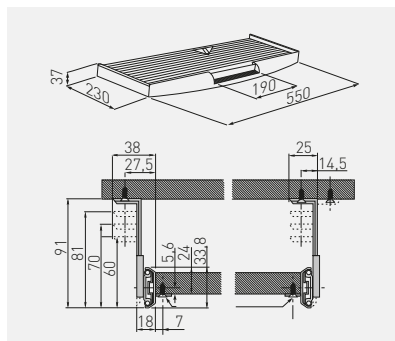

PU-KEYM27-20	černá / čierna / fekete / negro	plast plast műanyag plastic
PU-KEYM27-60	šedá / sivá / szürke / gri	



Vozík pod počítač  
 Vozík pod počítač  
 Gurulos asztali számítógép tartó  
 Cărucior pentru computer

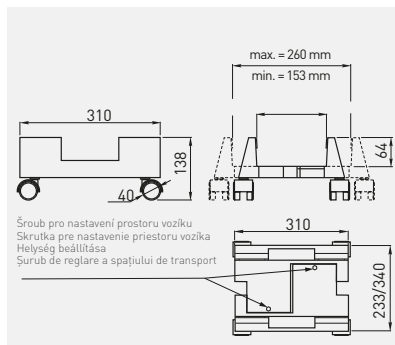

PU-PKO-00-20	černá / čierna / fekete / negro	plast plast műanyag plastic
PU-PKO-00-60	šedá / sivá / szürke / gri	



Hub - 4 USB ports  
 Hub - 4 USB port  
 Hub - 4 USB port  
 Hub - 4 porturi USB

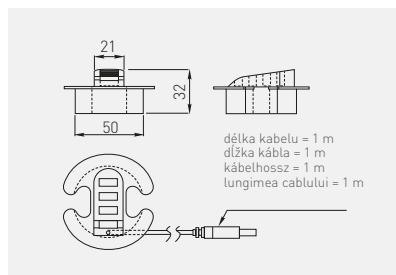

HB-USB-4X-60	stříbrný / stříborná / ezüst / argint	plast plast műanyag plastic
--------------	---------------------------------------	--------------------------------------



Průchodka kabelů pro stoly MERIDA 80  
 Priechodka káblov pre stoly MERIDA 80  
 Asztali kábelkivezető MERIDA 80  
 Trecere cablu pentru birou MERIDA 80

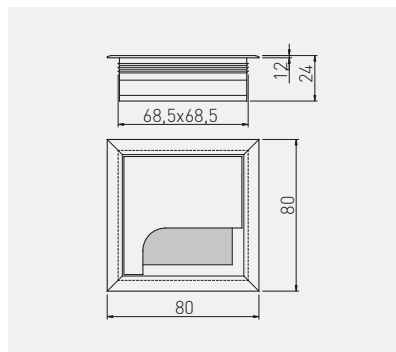



	 mm		
LB-K80X80-05	80 x 80	hliník / hliník / aluminium / aluminiu	
LB-K80X80-20		černá / čierna / fekete / negru	
		hliník hliník aluminium aluminiiu	

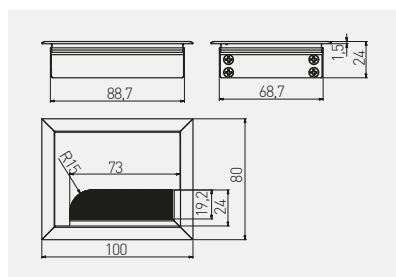

Průchodka kabelů pro stoly MERIDA 100  
 Priechodka káblov pre stoly MERIDA 100  
 Asztali kábelkivezető MERIDA 100  
 Trecere cablu pentru birou MERIDA 100



	 mm		
LB-80X100-05	80 x 100	hliník / hliník / aluminium / aluminiu	
LB-80X100-20		černá / čierna / fekete / negru	
		hliník hliník aluminium aluminiiu	



Průchodka kabelů pro stoly MERIDA 160  
 Priechodka káblov pre stoly MERIDA 160  
 Asztali kábelkivezető MERIDA 160  
 Trecere cablu pentru birou MERIDA 160

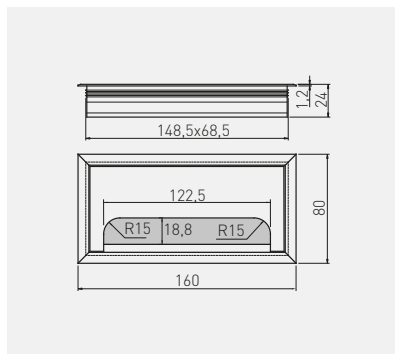

	 mm		
LB-80X160-05	80 x 160	hliník / hliník / alumínium / aluminiu	hliník hliník alumínium aluminiu
LB-80X160-20		černá / čierna / fekete / negru	



Průchodka kabelů pro stoly MERIDA 280  
 Priechodka káblov pre stoly MERIDA 280  
 Asztali kábelkivezető MERIDA 280  
 Trecere cablu pentru birou MERIDA 280

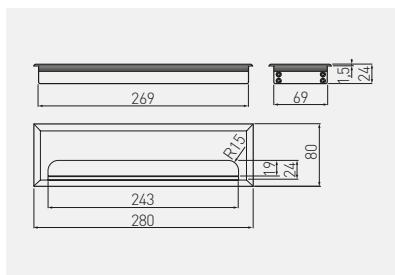



	 mm		
LB-80X280-05	80 x 280	hliník / hliník / alumínium / aluminiu	hliník hliník alumínium aluminiu
LB-80X280-20		černá / čierna / fekete / negru	

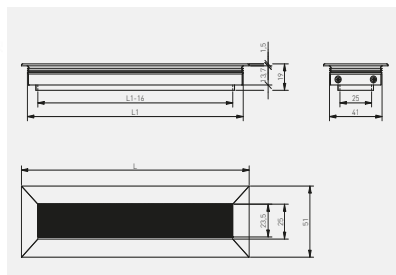

Průchodka kabelů pro stoly MERIDA  
 Priechodka káblov pre stoly MERIDA  
 Asztali kábelkivező MERIDA  
 Treceere cablu pentru birou MERIDA

NEW



L mm	L1 mm	hliník hliník aluminium aluminium	černá čierna fekete negru	hliník + plast hliník + plast aluminium + műanyag aluminium + plastic
180	170	–	LB-51x180-20	
180	170	LB-51X180-05	–	
450	440	–	LB-51x450-20	
450	440	LB-51X450-05	–	

Průchodka kabelů pro stoly MERIDA 500  
 Priechodka káblov pre stoly MERIDA 500  
 Asztali kábelkivező MERIDA 500  
 Treceere cablu pentru birou MERIDA 500

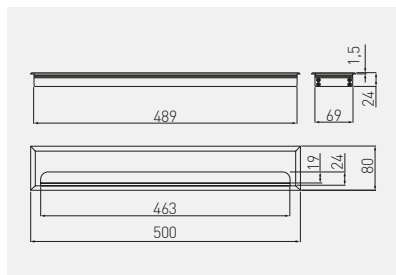

Icon	mm	hliník / hliník / aluminium / aluminium	černá / čierna / fekete / negru	hliník hliník aluminium aluminium
	80 x 500	hliník / hliník / aluminium / aluminium	černá / čierna / fekete / negru	hliník hliník aluminium aluminium
		hliník / hliník / aluminium / aluminium	černá / čierna / fekete / negru	



Průchodka kabelů LBF  
 Priechodka káblov LBF  
 Asztali kábelkivezető tömszelence LBF  
 Trecere cablu birou LBF

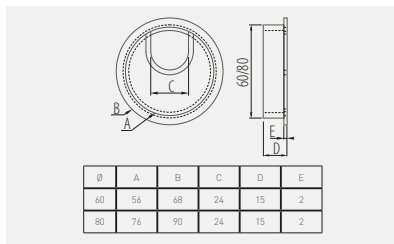

PM-LBF160-01	60	chrom / chróm / króm / crom	ZnAl
PM-LBF160-02		satén / satén / szatén / satin	
PM-LBF160-05		hliník / hliník / alumínium / aluminiu	
PM-LBF160-06		kartáčovaná ocel / kartáčovaná ocel / szálcsiszolt acél / oțel periat	
PM-LBF160-20M		černá matná / čierna matná / fekete matt / negru mat	
PM-LBF180-01	80	chrom / chróm / króm / crom	
PM-LBF180-02		satén / satén / szatén / satin	
PM-LBF180-05		hliník / hliník / alumínium / aluminiu	
PM-LBF180-06		kartáčovaná ocel / kartáčovaná ocel / szálcsiszolt acél / oțel periat	
PM-LBF180-20M		černá matná / čierna matná / fekete matt / negru mat	



Průchodka kabelů PLF  
 Priechodka káblov PLF  
 Asztali kábelkivezető tömszelence PFL  
 Trecere cablu birou PFL

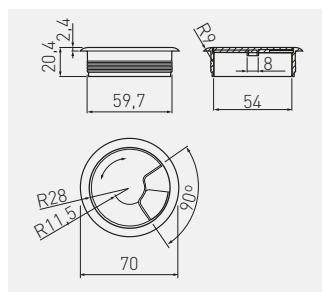

PM-PLF160-05	hliník / hliník / alumínium / aluminiu	plast plast műanyag plastic
PM-PLF160-10	bílá / biela / fehér / alb	
PM-PLF160-20	černá / čierna / fekete / negru	
PM-PLF160-30	šedá / sivá / szürke / gri	
PM-PLF160-43	světle hnědá / svetlo hnedá / világos barna / maro deschis	
PM-PLF160-45	vlašský ořech / vlašský ořech / dió / nuc	
PM-PLF160-47	buk / buk / bükkfa / fag	
PM-PLF160-49	javor / javor / juharfa / arțar	
PM-PLF160-50	běžová / béžová / bézs / bej	
PM-PLF160-51	kalvados / kalvados / calvados / calvados	



Zámek Z-138  
Zámok Z-138  
Fiókszár K-138  
Lacat K-138

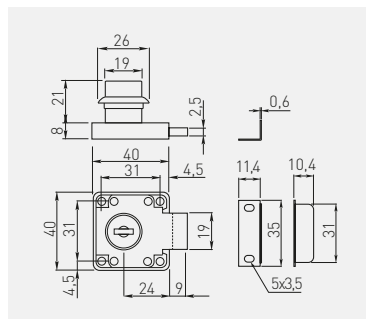

ZZ-KM-138-01-S



chrom / chróm / króm / crom



ZnAl + ocel / ZnAl + ocet / ZnAl + acél / ZnAl + oțel

Zámek Z-138 se sklopným klíčem  
Zámok Z-138 so sklopným kľúčom  
Fiókszár Z-138 összecukható kulccsal  
Lacat Z-138 cu cheie pliantă

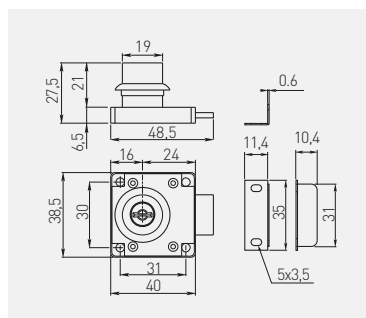

ZZ-ZN-138-01



chrom / chróm / króm / crom



ZnAl + ocel / ZnAl + ocet / ZnAl + acél / ZnAl + oțel



Zámek C-138 s klíčem  
 Zámok C-138 s kľúčom  
 Fiókszár C-138 kulccsal  
 Lacat C-138 cu cheie

Kompatibilní s klíčem MASTER  
 Kompatibilný s kľúčom MASTER  
 MASTER kulccsal kompatibilis  
 Compatibil cu chei MASTER

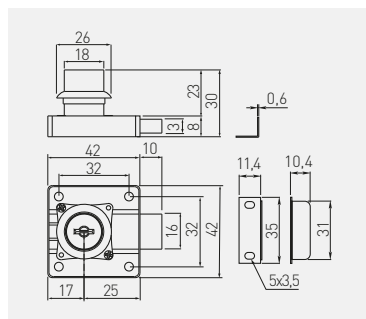

ZZ-CF-138-01



chrom / chróm / króm / crom



ZnAl + ocel / ZnAl + ocel / ZnAl + acél / ZnAl + oțel

Klíč MASTER do zámku C-138  
 Kľúč MASTER do zámku C-138  
 MASTER főkulcs a C-138 zárhoz  
 Cheie MASTER pentru lacat C-138



ZZ-KLMASTER



chrom / chróm / króm / crom



ZnAl + ocel / ZnAl + ocel / ZnAl + acél / ZnAl + oțel

Kontajnerový zámek Z-338  
 Kontajnerový zámok Z-338  
 Szögletes fiókszár Z-338  
 Lacat pãtrată Z-338

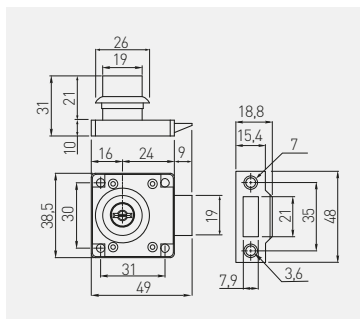

ZZ-ZN-338-01-S



chrom / chróm / króm / crom



ZnAl + ocel / ZnAl + ocel / ZnAl + acél / ZnAl + oțel

Bajonetový zámek B-105  
 Bajonetový zámok B-105  
 Tolóajtózár B-105  
 Lacat cu bolt B-105

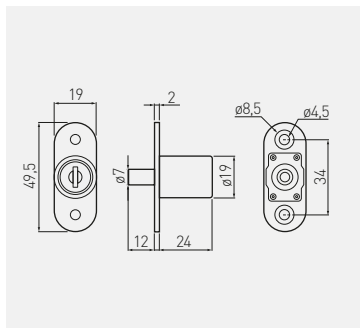

ZZ-B0-105-01-S



chrom / chróm / króm / crom



ZnAl + ocel / ZnAl + ocel / ZnAl + acél / ZnAl + oțel

Skříňkový zámek Z-103  
 Skrinkový zámok Z-103  
 Fémbütorzár Z-103  
 Lacat cutie postala Z-103

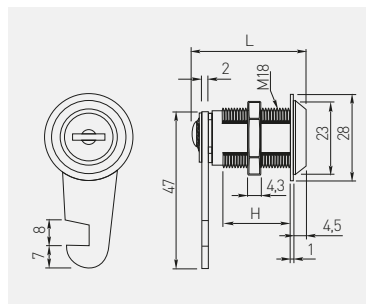

		 L mm	 H mm		
ZZ-16-103-01-S		27	12	chrom / chróm / króm / crom	ZnAl + ocel / ZnAl + ocel / ZnAl + acél / ZnAl + oțel
ZZ-20-103-01-S		30	16,5		
ZZ-30-103-01-S		40	26,5		

Zámek na sklo S-409  
 Zámok na sklo S-409  
 Üvegajtó zár S-409  
 Încuietoare ușă din sticlă S-409

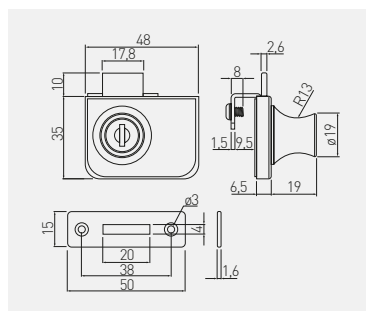

Pro sklo 4 - 8 mm  
 Pre sklo 4 - 8 mm  
 4 - 8 mm vastag üveghez  
 Pentru sticlă 4 - 8 mm

			
ZZ-SZ-409-01-S		chrom / chróm / króm / crom	ZnAl + ocel / ZnAl + ocel / ZnAl + acél / ZnAl + oțel

Zámek M-201  
Zámok M-201  
Szekrényzár M-201  
Lacat M-201

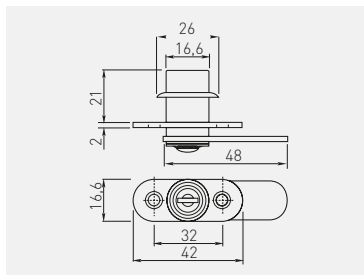

ZZ-M0-201-01-S



chrom / chróm / króm / crom



ocel + plast + ZnAl / ocel + plast + ZnAl / acél + műanyag + ZnAl / oțel + plastic + ZnAl

Zámek na žaluzie Z-202  
Zámok na žalúzie Z-202  
Redőnyzár Z-202  
Lacat cu gheara dublu Z-202

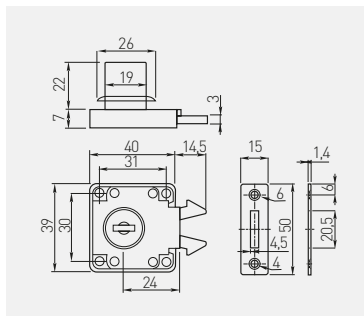

ZZ-Z0-202-01-S



chrom / chróm / króm / crom



ocel + plast + ZnAl / ocel + plast + ZnAl / acél + műanyag + ZnAl / oțel + plastic + ZnAl

Zámek na posuvné sklo G-328  
 Zámek na posuvné sklo G-328  
 Toló üvegajtózár G-328  
 Lacat pentru ușă culisanta din sticlă G-328

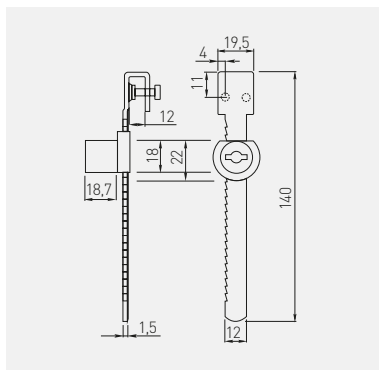

Pro sklo 4 – 8 mm  
 Pre sklo 4 – 8 mm  
 4 - 8 mm vastag üveghez  
 Pentru sticlă 4 - 8 mm



ZZ-G0-328-01



chrom / chróm / króm / crom



ZnAl + ocel / ZnAl + ocel / ZnAl + acél / ZnAl + oțel

Trojcestný zámek  
 Trojcestný zámok  
 Szekrényrúdzár  
 Lacat cu zavor

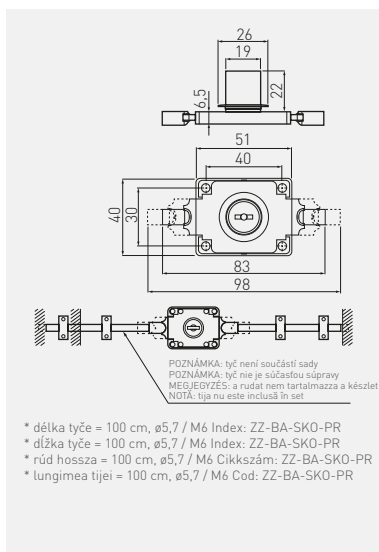

\* délka tyče = 100 cm, ø5,7 / M6 Index: ZZ-BA-SK0-PR  
 \* dĺžka tyče = 100 cm, ø5,7 / M6 Index: ZZ-BA-SK0-PR  
 \* rúd hossza = 100 cm, ø5,7 / M6 Cikkszám: ZZ-BA-SK0-PR  
 \* lungimea tije = 100 cm, ø5,7 / M6 Cod: ZZ-BA-SK0-PR



ZZ-BA-SK0-01-S

chrom / chróm / króm / crom



ZZ-BA-SK0-PR

pozinkovaný / pozinkovaný / galvanizált / galvanizat



ocel / ocel / acél / oțel

Centrální zámek C-288  
 Centrálny zámok C-288  
 Szekrény fiókszár C-288  
 Inchidere centralizata C-288

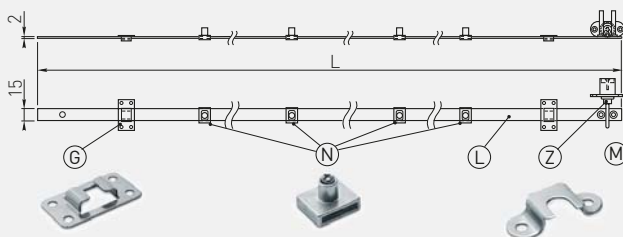
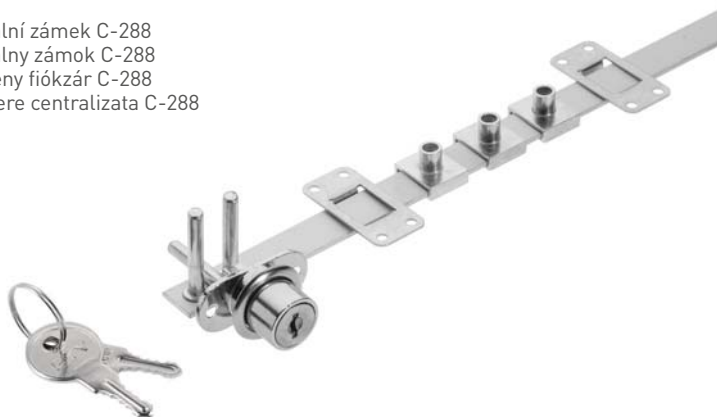

Sada / Súprava / Szett / Set

- G** Upevňovací lišty / Upevnenie lišty / Rács rögzítése / Fixarea lamelor
- N** Zajišťovací mechanismus zásuvky / Zaisťovací mechanizmus zásuvky / Fiókjáró mechanizmus / Mecanism de blocare a sertarelor
- L** Lišta zámku / Lišta zámku / Zárács / Lamă de blocare
- Z** Zámek / Zámok / Zár / Lacăt
- M** Háček / Háčik / Fogas / Agatator

Model	C5	C6	C8	C1
L	500	600	800	1200
N	3	3	4	4
M	3	3	4	4
G	2	2	3	3

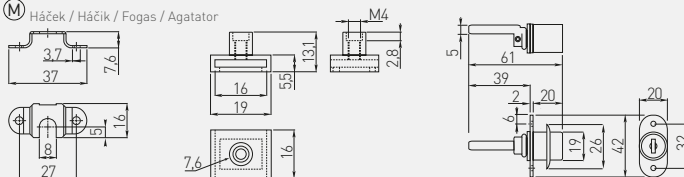

Icon	L mm	Material	Material
	500	chrom / chróm / króm / crom	ZnAl + ocel / ZnAl + ocel / ZnAl + acél / ZnAl + oțel
	600		
	800		
	1200		
	-	stříbrný / strieborná / ezüst / argint	ocel + plast / ocel + plast / acél + műanyag / oțel + plastic
	-	chrom / chróm / króm / crom	

Větrací mřížka sokla  
 Vetracia mriežka sokla  
 Szellőzőrács  
 Ventilatie

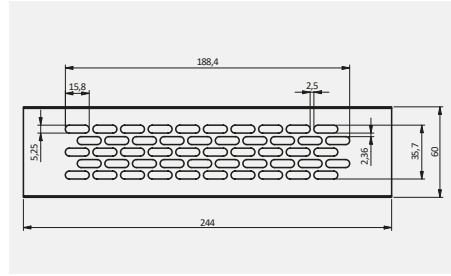





KK-W60245-M0	průtok vzduchu - 40 cm <sup>2</sup> prietok vzduchu - 40 cm <sup>2</sup> légáteresztés - 40 cm <sup>2</sup> debit de aer - 40 cm <sup>2</sup>	hliník / hliník / alumínium / aluminiu	hliník hliník alumínium aluminiu
KK-W60245-M1		bílá / biela / fehér / alb	
KK-W60245-M2		černá / čierna / fekete / negru	
KK-W60245-M6		kartáčovaná ocel / kartáčovaná ocel / szálcsiszolt acél / oțel periat	
KK-W60245-Z4		antracitová / antracitová / antracit / antracit	
KK-W60245-21		zlato / zlato / arany / aur	

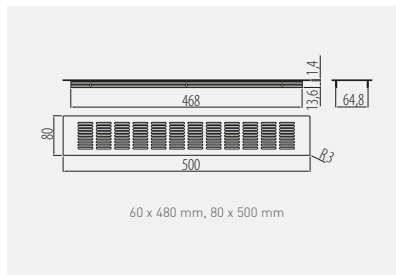

Větrací mřížka sokla D50-80  
 Vetracia mriežka sokla D50-80  
 Szellőzőrács  
 Ventilatie





 KK-D50-80-06	 průtok vzduchu – 108 cm <sup>2</sup> prietok vzduchu – 108 cm <sup>2</sup> légáteresztés - 108 cm <sup>2</sup> debit de aer - 108 cm <sup>2</sup>	 kartáčovaná ocel, kartáčovaná ocel, szálciszolt acél, oțel periat	 hliník hliník aluminium aluminiu
---	---	---	--

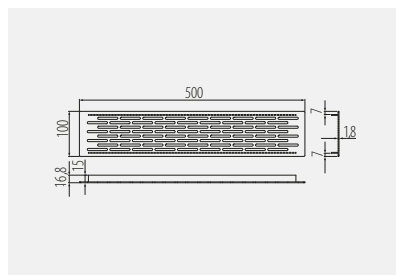

Větrací mřížka sokla D50-100  
 Vetracia mriežka sokla D50-100  
 Szellőzőrács D50-100  
 Ventilatie D50-100



 KK-D50100-06	 průtok vzduchu – 130 cm <sup>2</sup> prietok vzduchu – 130 cm <sup>2</sup> légáteresztés - 130 cm <sup>2</sup> debit de aer - 130 cm <sup>2</sup>	 kartáčovaná ocel, kartáčovaná ocel, szálciszolt acél, oțel periat	 hliník hliník aluminium aluminiu
---	---	---	--





Větrací mřížka sokla W60  
 Vetracia mriežka sokla W60  
 Szellőzőrács W60  
 Ventilatie W60

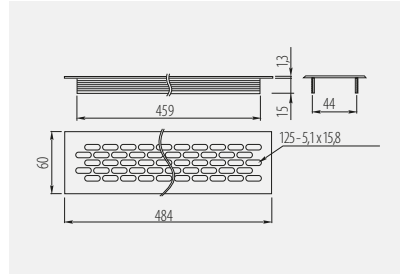

KK-W60800-M0	průtok vzduchu - 94 cm <sup>2</sup> prietok vzduchu - 94 cm <sup>2</sup> légáteresztés - 94 cm <sup>2</sup> debit de aer - 94 cm <sup>2</sup>	šedá / sivá / szürke / gri	hliník hliník aluminium aluminiu
KK-W60800-M1		bílá / biela / fehér / alb	
KK-W60800-M2		černá / čierna / fekete / negro	
KK-W60800-24		antracitová / antracitová / antracit / antracit	
KK-W60800-06		kartáčovaná ocel / kartáčovaná ocel / szálcsiszolt acél / oțel periat	
KK-W60800-21		zlato / zlato / arany / aur	



Větrací mřížka sokla W80  
 Vetracia mriežka sokla W80  
 Szellőzőrács W80  
 Ventilatie W80

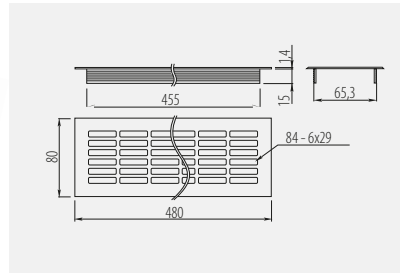

KK-W80800-D0	průtok vzduchu - 146 cm <sup>2</sup> prietok vzduchu - 146 cm <sup>2</sup> légáteresztés - 146 cm <sup>2</sup> debit de aer - 146 cm <sup>2</sup>	šedá / sivá / szürke / gri	hliník hliník aluminium aluminiu
KK-W80800-D1		bílá / biela / fehér / alb	
KK-W80800-D2		černá / čierna / fekete / negro	
KK-W80800-24		antracitová / antracitová / antracit / antracit	
KK-W80800-06		kartáčovaná ocel / kartáčovaná ocel / szálcsiszolt acél / oțel periat	
KK-W80800-21		zlato / zlato / arany / aur	



Větrací mřížka soklu W80  
 Vetracia mriežka sokla W80  
 Szellőzőrács W80  
 Ventilatie W80

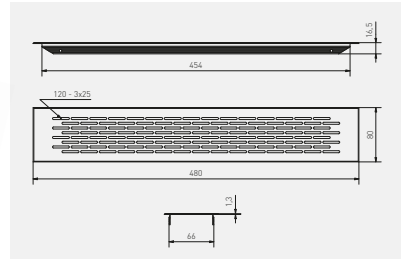

KK-W80480-05	průtok vzduchu - 146 cm <sup>2</sup> prietok vzduchu - 146 cm <sup>2</sup> légáteresztés - 146 cm <sup>2</sup> debit de aer - 146 cm <sup>2</sup>	šedá / sivá / szürke / gri	hliník hliník aluminium aluminium
KK-W80480-10		bílá / biela / fehér / alb	
KK-W80480-20M		černá / čierna / fekete / negro	
KK-W80480-24		antracitová / antracitová / antracit / antracit	
KK-W80480-06		kartáčovaná ocel / kartáčovaná ocel / szálcsiszolt acél / ojel periat	
KK-W80480-21		zlato / zlato / arany / aur	



Kruhová točna  
 Kruhová točna  
 Kerek TV forgó konzol  
 Suport rotativ rotund

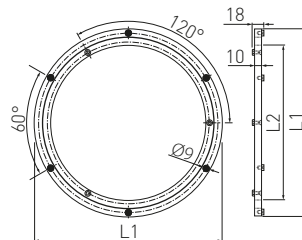





OM-OB0300-05	300	248	60	hliník hliník aluminium aluminium	hliník hliník aluminium aluminium
OM-OB0400-05	400	338	100		

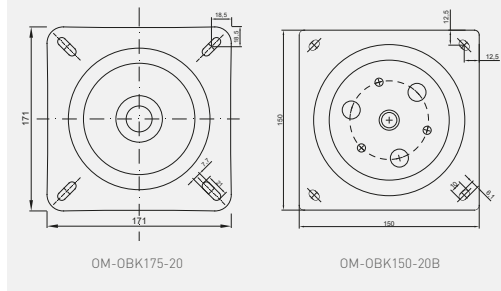

Čtvercová točna  
 Štvorcová točňa  
 Szögletes TV forgó konzol  
 Suport rotativ pătrat



			
OM-OBK150-20B	50	černá čierna fekete negru	ocel ocel acél oțel
OM-OBK175-20*	100		



**DEKORATIVNÍ PŘÍSLUŠENSTVÍ**  
**DEKORATÍVNE DOPLNKY**  
**DEKORATÍV KIEGÉSZÍTŐK**  
**ACCESORII DECORATIVE**

Úchytky Úchytky Fogantyúk Mânere	340 – 447
Věšáky Vešiaky Fogasok Agatatoare	448 – 455
Policové podpěry Policové podpery Polctartók Suporturi pentru raft	456 – 463
Nábytkové nohy a podpěry Nábytkové nohy Bútorlábak Picioare de mobilier	464 – 484
Nábytkové nohy Nábytkové nohy Bútor görgők Rotile pentru mobilă	485 – 499
Nábytková kolečka Nábytková kolieska Alsó rendszerek Sisteme de rulare inferioare	500 – 505



Úchytka EXTEND  
 Úchytka EXTEND  
 Fogantyú EXTEND  
 Mâner EXTEND

NEW

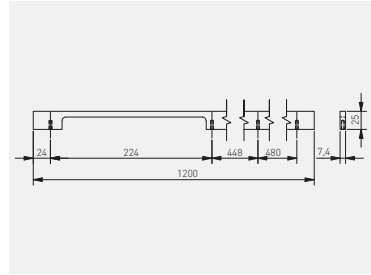

MODERN

C  
mm

L  
mm







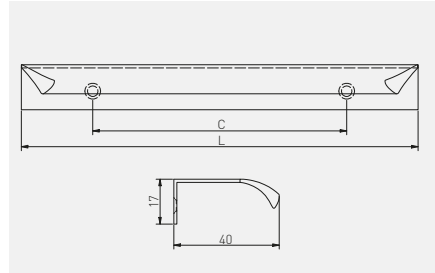

C mm	L mm				
224/448/480	1200	bílám biela, fehér, alb	černá matná, čierna matná, fekete matt, negru mat	zlato, zlato, arany, aur	hliník, hliník, aluminium, aluminiumu
		UA-EXTEND-1200-10M	UA-EXTEND-1200-20M	UA-EXTEND-1200-22	



Úchytka HEXA LONG  
 Úchytka HEXA LONG  
 Fogantyú HEXA LONG  
 Mâner HEXA LONG



 C mm	 L mm		
352	1200	hliník, hliník, aluminium, aluminium	bílá matná, biela matná, fehér matt, alb mat
		UA-HEXA-1200-05	UA-HEXA-1200-10M
352	1200		
		černá matná, čierna matná, fekete matt, negru mat	zlato, zlato, arany, aur
		hliník, hliník, aluminium, aluminium	



Úchytka OCTAVIO  
 Úchytka OCTAVIO  
 Fogantyú OCTAVIO  
 Mâner OCTAVIO

NEW

MODERN



C	L	chrom, chróm, króm, crom	mosaz, mosadz, sârgaréz, alamâ	kartáčovaná ocel, kartáčovaná ocel, szálcsiszolt acél, oţel periat	kartáčované zlato, kartáčované zlato, szálcsiszolt arany, aur periat	černá matná, čierna matná, fekete matná, negru mat	ZnAl
128	139	UZ-OCTAVIO-128-01	UZ-OCTAVIO-128-03	UZ-OCTAVIO-128-06	UZ-OCTAVIO-128-18	UZ-OCTAVIO-128-20M	
160	171	UZ-OCTAVIO-160-01	UZ-OCTAVIO-160-03	UZ-OCTAVIO-160-06	UZ-OCTAVIO-160-18	UZ-OCTAVIO-160-20M	
192	203	UZ-OCTAVIO-192-01	UZ-OCTAVIO-192-03	UZ-OCTAVIO-192-06	UZ-OCTAVIO-192-18	UZ-OCTAVIO-192-20M	

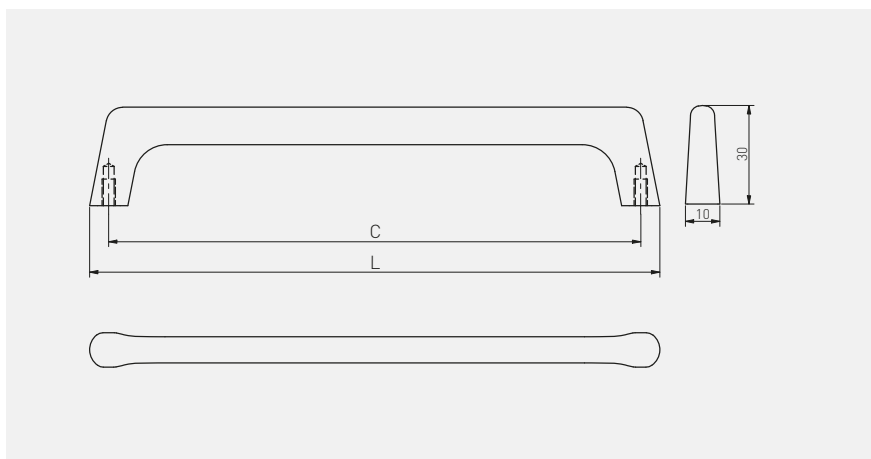





Úchytka CAPRI  
 Úchytka CAPRI  
 Fogantyú CAPRI  
 Mâner CAPRI

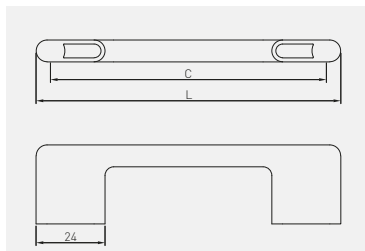

C	L	chrom, chróm, króm, crom	satén satén szatén satin	hliník, hliník, aluminium, aluminiiu	kartáčovaná oceľ, kartáčovaná oceľ, szálciszott acél, oțel periat	černá matná, čierna matná, fekete matt, negru mat	
96	106	UZ-CAPRI-96-01	UZ-CAPRI-96-02	UZ-CAPRI-96-05	UZ-CAPRI-96-06	-	
128	138	UZ-CAPRI-128-01	UZ-CAPRI-128-02	UZ-CAPRI-128-05	UZ-CAPRI-128-06	UZ-CAPRI-128-20M	ZnAl
160	170	UZ-CAPRI-160-01	UZ-CAPRI-160-02	UZ-CAPRI-160-05	UZ-CAPRI-160-06	UZ-CAPRI-160-20M	
192	202	UZ-CAPRI-192-01	UZ-CAPRI-192-02	UZ-CAPRI-192-05	UZ-CAPRI-192-06	UZ-CAPRI-192-20M	
256	266	UZ-CAPRI-256-01	UZ-CAPRI-256-02	UZ-CAPRI-256-05	UZ-CAPRI-256-06	UZ-CAPRI-256-20M	
320	330	UZ-CAPRI-320-01	UZ-CAPRI-320-02	UZ-CAPRI-320-05	UZ-CAPRI-320-06	-	



Úchytka SPOT  
 Úchytka SPOT  
 Fogantyú SPOT  
 Mâner SPOT

NEW

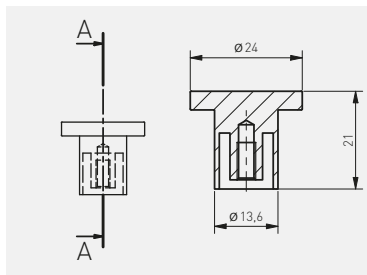

	mosaz, mosadz, sárgaréz, alamâ	kartáçovaná oceľ, kartáçovaná oceľ, szálcsiszolt acél, oţel periat	kartáçované zlato, kartáçované zlato, szálcsiszolt arany, aur periat	ãerná matná, ãierna matná, fekete matt, negru mat	bílâm biela, fehér, alb	ZnAl
<b>Knopka Knopka Gomb fogantyú Buton</b>	GZ-SPOT-1-03	GZ-SPOT-1-06	GZ-SPOT-1-18	GZ-SPOT-1-20M	GZ-SPOT-1-10	



Úchytka BAGIO  
 Úchytka BAGIO  
 Fogantyú BAGIO  
 Mâner BAGIO

NEW

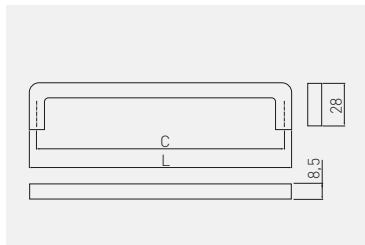

C mm	L mm					
		chrom, chróm, króm, crom	starožitná mosaz starožitná mosadz antik bronz alama antică	hliník, hliník, aluminium, aluminium	kartáčovaná ocel, kartáčovaná oceľ, szálcsiszolt acél, oțel periat	ZnAl
128	136	UZ-BAGIO-128-01	UZ-BAGIO-128-04	UZ-BAGIO-128-05	UZ-BAGIO-128-06	
160	168	UZ-BAGIO-160-01	UZ-BAGIO-160-04	UZ-BAGIO-160-05	UZ-BAGIO-160-06	
192	200	UZ-BAGIO-192-01	UZ-BAGIO-192-04	UZ-BAGIO-192-05	UZ-BAGIO-192-06	
320	328	UZ-BAGIO-320-01	UZ-BAGIO-320-04	UZ-BAGIO-320-05	UZ-BAGIO-320-06	

C mm	L mm						
		starožitné striebro starožitné striebro antik ezüst argint antic	kartáčovaný titan kartáčovaný titán csiszolt titán titan periat	měď međ rész cupru	šampaňská šampanská pezsgő sampanie	černá matná, čierna matná, fekete matt, negru mat	ZnAl
128	136	UZ-BAGIO-128-07	UZ-BAGIO-128-11	UZ-BAGIO-128-15	UZ-BAGIO-128-90	UZ-BAGIO-128-20M	
160	168	UZ-BAGIO-160-07	UZ-BAGIO-160-11	UZ-BAGIO-160-15	UZ-BAGIO-160-90	UZ-BAGIO-160-20M	
192	200	UZ-BAGIO-192-07	UZ-BAGIO-192-11	UZ-BAGIO-192-15	UZ-BAGIO-192-90	UZ-BAGIO-192-20M	
320	328	UZ-BAGIO-320-07	UZ-BAGIO-320-11	UZ-BAGIO-320-15	UZ-BAGIO-320-90	UZ-BAGIO-320-20M	



Úchytka VITO  
 Úchytka VITO  
 Fogantyú VITO  
 Mâner VITO

NEW

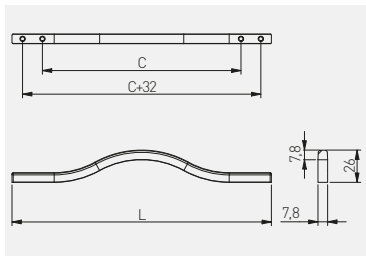

C  
mm

L  
mm



		chrom, chróm, króm, crom	hliník, hliník, aluminium, aluminiumu	starožitné striebro antik ezüst argint antic	ZnAl
160	210	UZ-VITO-160-01	UZ-VITO-160-05	UZ-VITO-160-07	
288	340	UZ-VITO-288-01	UZ-VITO-288-05	UZ-VITO-288-07	
C mm	L mm				
		černá, chrom čierna, chróm fekete, króm negru, crom	zlatá mosaz, zlatá mosadz, aranyrész, alamä aurie	černá matná, čierna matná, fekete matt, negru mat	ZnAl
160	210	UZ-VITO-160-12	UZ-VITO-160-16	UZ-VITO-160-20M	
288	340	UZ-VITO-288-12	UZ-VITO-288-16	UZ-VITO-288-20M	



Knopka DUNE  
 Knopka DUNE  
 Gomb fogantyú DUNE  
 Buton DUNE

NEW

MODERN

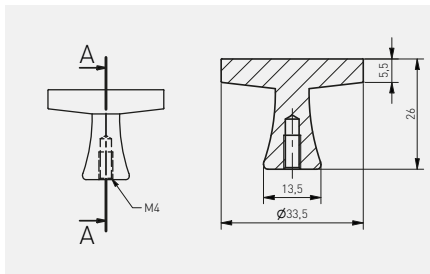

	kartáčovaná oceľ, kartáčovaná oceľ, szálcsiszolt acél, ořel periat	zlatá mosaz, zlatá mosadz, aranyrész, alamá aurie	černá matná, čierna matná, fekete matt, negru mat	
<b>Knopka Knopka Gomb fogantyú Buton</b>	GZ-DUNE-1-06	GZ-DUNE-1-16	GZ-DUNE-1-20M	ZnAl



Knopka PIAZZA  
 Knopka PIAZZA  
 Gomb fogantyú PIAZZA  
 Buton PIAZZA

NEW

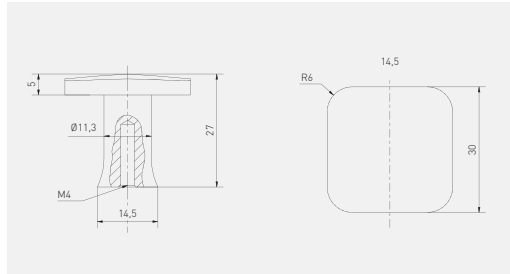

	mosaz, mosadz, sárgaréz, alamá	kartáčovaná ocel, kartáčovaná ocel, szálcsiszolt acél, oţel periat	kartáčované zlato, kartáčované zlato, szálcsiszolt arany, aur periat	černá matná, čierna matná, fekete matt, negru mat	
<b>Knopka Knopka Gomb fogantyú Buton</b>	GZ-PIAZZA-1-03	GZ-PIAZZA-1-06	GZ-PIAZZA-1-18	GZ-PIAZZA-1-20M	ZnAl



Úchytka FLAVIO  
 Úchytka FLAVIO  
 Fogantyú FLAVIO  
 Mâner FLAVIO

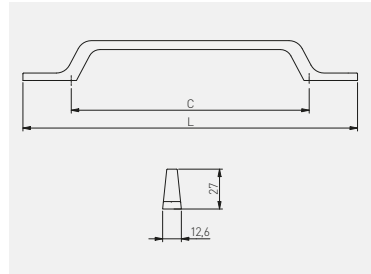

C  
mm

L  
mm









		chrom, chróm, króm, crom	mosaz, mosadz, sárgaréz, alamâ	kartáčovaná ocel, kartáčovaná ocel, szálcsiszolt acél, oţel perlat	zlatá mosaz, zlatá mosadz, aranyréz, alamâ aurie	černá matná, čierna matná, fekete matt, negru mat	
96	161	UZ-FLAVIO-96-01	UZ-FLAVIO-96-03	UZ-FLAVIO-96-06	UZ-FLAVIO-96-16	UZ-FLAVIO-96-20M	ZnAl
128	193	UZ-FLAVIO-128-01	UZ-FLAVIO-128-03	UZ-FLAVIO-128-06	UZ-FLAVIO-128-16	UZ-FLAVIO-128-20M	
160	225	UZ-FLAVIO-160-01	UZ-FLAVIO-160-03	UZ-FLAVIO-160-06	UZ-FLAVIO-160-16	UZ-FLAVIO-160-20M	
192	200	-	UZ-FLAVIO-192-03	UZ-FLAVIO-192-06	UZ-FLAVIO-192-16	UZ-FLAVIO-192-20M	
320	328	-	UZ-FLAVIO-320-03	UZ-FLAVIO-320-06	UZ-FLAVIO-320-16	UZ-FLAVIO-320-20M	

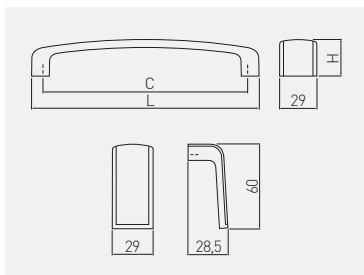







Úchytka MONZA  
 Úchytka MONZA  
 Fogantyú MONZA  
 Mâner MONZA

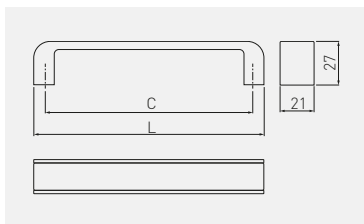

 C mm	 L mm	 H mm				
160	178	29	kartáčovaná oceľ, chróm kartáčovaná oceľ, chróm szálcsiszolt acél, króm ojet periat, crom	bilá, chróm biela, chróm fehér, króm alb, crom	černá, chróm čierna, chróm fekete, króm negru, crom	hliník + ZnAl hliník + ZnAl aluminium + ZnAl aluminium + ZnAl
256	274	33	UZ-MONZA256-06	UZ-MONZA256-10	UZ-MONZA256-20	
384	402	34	UZ-MONZA384-06	UZ-MONZA384-10	UZ-MONZA384-20	



Úchytka MONA  
 Úchytka MONA  
 Fogantyú MONA  
 Mâner MONA



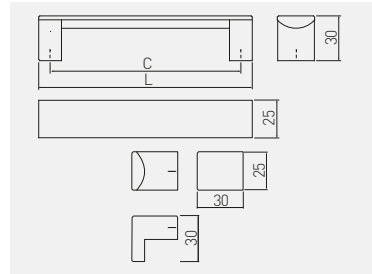

 C mm	 L mm			
128	142	bilá, chróm biela, chróm fehér, króm alb, crom	černá, chróm čierna, chróm fekete, króm negru, crom	ZnAl
192	206	UZ-MONA-192-01-10	UZ-MONA-192-01-20	
256	270	UZ-MONA-256-01-10	UZ-MONA-256-01-20	

Úchytka ARES  
 Úchytka ARES  
 Fogantyú ARES  
 Mâner ARES



C mm	L mm		
		černá, čierna, fekete, negru	hliník, hliník, aluminium, aluminu
96	111	UA-ARS096-20	
128	143	UA-ARS128-20	
160	175	UA-ARS160-20	
192	207	UA-ARS192-20	
224	239	UA-ARS224-20	

C mm	L mm		
		černá, čierna, fekete, negru	hliník, hliník, aluminium, aluminu
256	271	UA-ARS256-20	
320	335	UA-ARS320-20	
<b>Knopka Knopka Gomb fogantyú Buton</b>		UA-ARSG30-20	



Úchytka UZ-G2  
 Úchytka UZ-G2  
 Fogantyú UZ-G2  
 Mâner UZ-G2

NEW

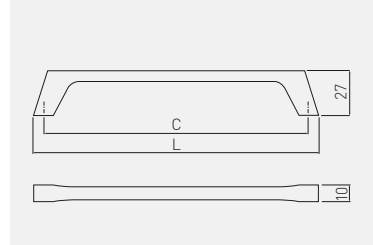

C mm	L mm				
		chrom, chróm, króm, crom	kartáčovaná oceľ, kartáčovaná oceľ, szálcsiszolt acél, oțel periat	černá matná, čierna matná, fekete matt, negru mat	ZnAl
160	172	UZ-G2-160-01	UZ-G2-160-06	UZ-G2-160-20M	
224	236	UZ-G2-224-01	UZ-G2-224-06	UZ-G2-224-20M	

MODERN



Úchytka MILANO  
 Úchytka MILANO  
 Fogantyú MILANO  
 Mâner MILANO

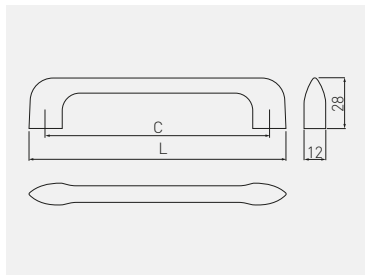

MODERN

C mm	L mm					
C	L	chrom, chróm, króm, crom	hliník, hliník, aluminíum, átumínium	kartáčovaná oceľ, kartáčovaná oceľ, szálcsiszolt acél, otet periat	černá matná, čierna matná, fekete matt, negru mat	
128	146	UZ-MILAN-128-01	UZ-MILAN-128-05	UZ-MILAN-128-06	UZ-MILAN-128-20M	ZnAl
256	274	UZ-MILAN-256-01	UZ-MILAN-256-05	UZ-MILAN-256-06	UZ-MILAN-256-20M	
Knopka Knopka Gomb fogantyú Buton		-	-	-	GZ-MILAN-32-20M	



Úchytka UZ-133  
 Úchytka UZ-133  
 Fogantyú UZ-133  
 Mâner UZ-133

NEW

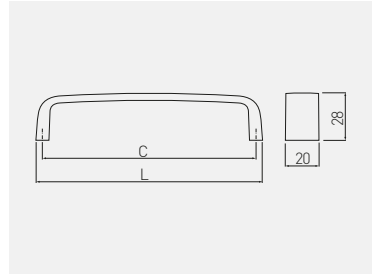

		chrom, chróm, króm, crom	satén szatén satin	hliník, hliník, aluminium, aluminium	kartáčovaná oceľ, kartáčovaná oceľ, szálciszott acél, oţel periat	černá matná, čierna matná, fekete matt, negru mat	ZnAl
128	135	UZ-133128-01	UZ-133128-02	UZ-133128-05	UZ-133128-06	UZ-133128-20M	

MODERN



Úchytka MODENA  
 Úchytka MODENA  
 Fogantyú MODENA  
 Mâner MODENA

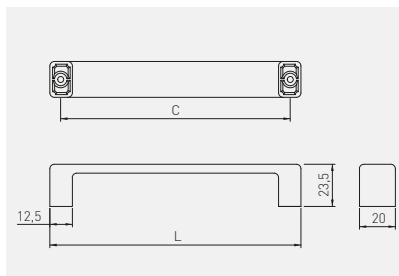

C  
mm

L  
mm



C	L	chrom, chróm, króm, crom	hliník, hliník, aluminium, aluminiiu	kartáčovaná oceľ, kartáčovaná oceľ, szálciszolt acél, ojel periat	černá matná, čierna matná, fekete matt, negru mat	ZnAl
128	140	UZ-MODEN-128-01	UZ-MODEN-128-05	UZ-MODEN-128-06	UZ-MODEN-128-20M	ZnAl
160	172	UZ-MODEN-160-01	UZ-MODEN-160-05	UZ-MODEN-160-06	UZ-MODEN-160-20M	
192	204	UZ-MODEN-192-01	UZ-MODEN-192-05	UZ-MODEN-192-06	UZ-MODEN-192-20M	



Úchytka UZ-40  
 Úchytka UZ-40  
 Fogantyú UZ-40  
 Mâner UZ-40

NEW

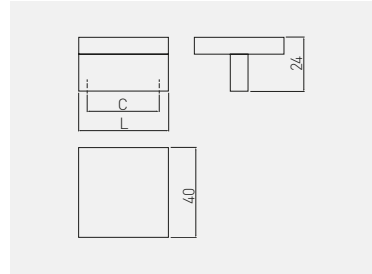

MODERN

C  
mm

L  
mm



		chrom, chróm, króm, crom	satén satén szatén satin	hliník, hliník, aluminium, aluminu	kartáčovaná ocel, kartáčovaná ocel, szálciszolt acél, oțel periat	černá matná, čierna matná, fekete matt, negru mat	ZnAl
32	40	UZ-40-032-01	UZ-40-032-02	UZ-40-032-05	UZ-40-032-06	UZ-40-032-20M	



Úchytka UZ-334  
 Úchytka UZ-334  
 Fogantyú UZ-334  
 Mâner UZ-334

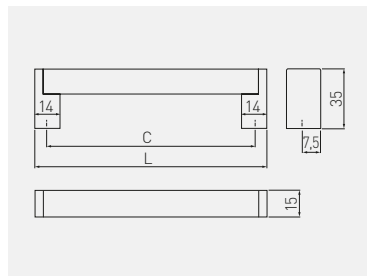

MODERN



mm



mm



C	L		
mm	mm		
		kartáčovaná ocel, kartáčovaná ocel, szálcsiszolt acél, ořel periat	
128	144	UZ-334128-06	ZnAl + ocel ZnAl + ocel ZnAl + acél ZnAl + ořel
160	175	UZ-334160-06	
192	206	UZ-334192-06	
256	272	UZ-334256-06	
320	335	UZ-334320-06	

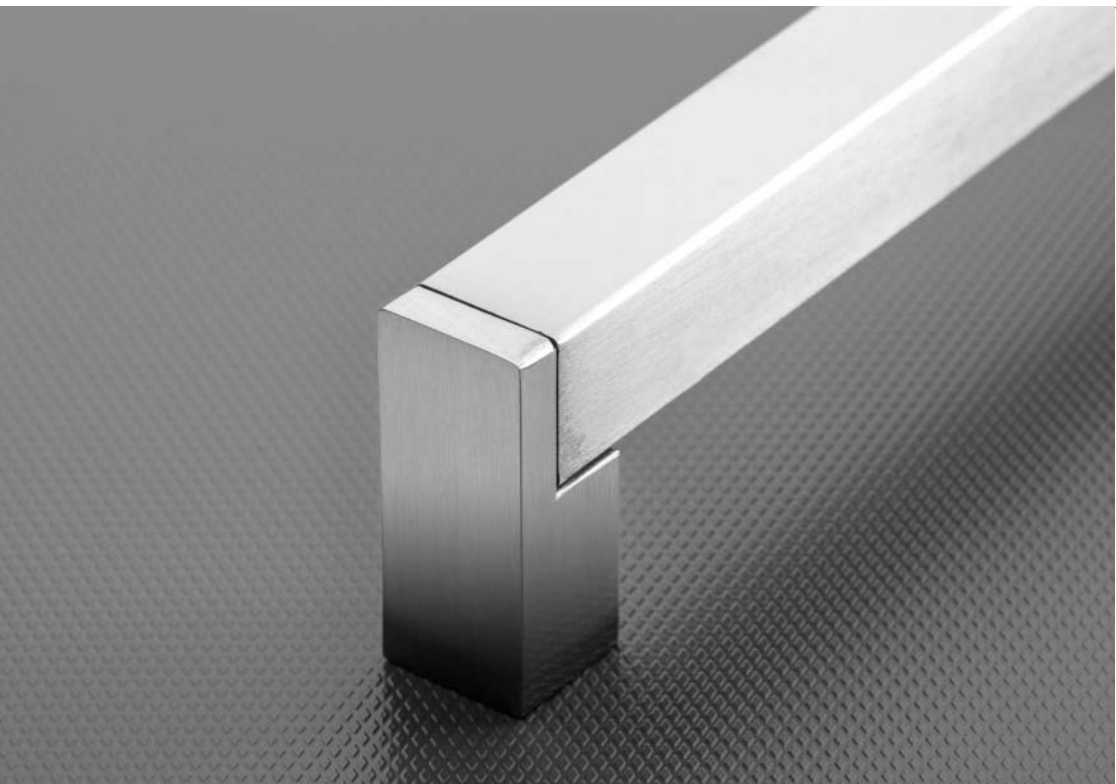



Úchytka UZ-336  
 Úchytka UZ-336  
 Fogantyú UZ-336  
 Mâner UZ-336

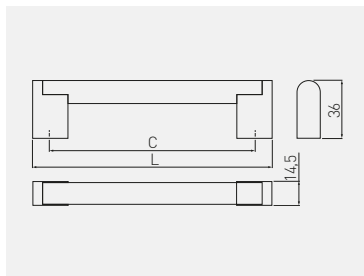

C mm	L mm		
		kartáčovaná ocel, kartáčovaná ocel, szálcsiszolt acél, ojet periat	ZnAl + ocel ZnAl + ocel ZnAl + acél ZnAl + ojet
128	148	UZ-336128-06	
160	182	UZ-336160-06	
192	213	UZ-336192-06	
256	276	UZ-336256-06	
320	340	UZ-336320-06	
416	436	UZ-336416-06	
480	500	UZ-336480-06	

Úchytka UZ-682  
 Úchytka UZ-682  
 Fogantyú UZ-682  
 Mâner UZ-682

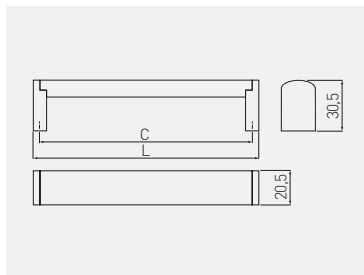

C mm	L mm			C mm	L mm		
		kartáčovaná ocel, kartáčovaná ocel, szálcsiszolt acél, ojet periat	ZnAl + ocel ZnAl + ocel ZnAl + acél ZnAl + ojet			kartáčovaná ocel, kartáčovaná ocel, szálcsiszolt acél, ojet periat	ZnAl + ocel ZnAl + ocel ZnAl + acél ZnAl + ojet
128	136	UZ-682128-06		256	266	UZ-682256-06	
160	170	UZ-682160-06		320	329	UZ-682320-06	
192	209	UZ-682192-06		416	425	UZ-682416-06	
224	232	UZ-682224-06		480	489	UZ-682480-06	

Úchytka UA-B311  
 Úchytka UA-B311  
 Fogantyú UA-B311  
 Mâner UA-B311

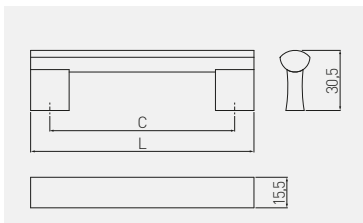

C  
mm

L  
mm



C	L	hliník, hliník, aluminium, aluminu	černá, čierna, fekete, negru	hliník, hliník, aluminium, aluminu
96	116	UA-B0-311096	UA-B0-311096-20M	
128	148	UA-B0-311128	UA-B0-311128-20M	
160	180	UA-B0-311160	UA-B0-311160-20M	
192	212	UA-B0-311192	UA-B0-311192-20M	
224	244	UA-B0-311224	UA-B0-311224-20M	
256	276	UA-B0-311256	UA-B0-311256-20M	
288	307	UA-B0-311288	UA-B0-311288-20M*	
320	340	UA-B0-311320	UA-B0-311320-20M	
480	500	UA-B0-311480	UA-B0-311480-20M*	

\*K dispozici pro speciální objednávky / K dispozicii na špeciálne objednávky / Külön megrendelésben kapható / Disponibil pentru comenzi speciale

Úchytka UA-319  
 Úchytka UA-319  
 Fogantyú UA-319  
 Mâner UA-319

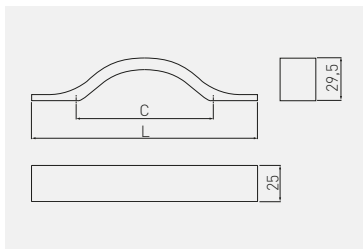

C  
mm





L  
mm

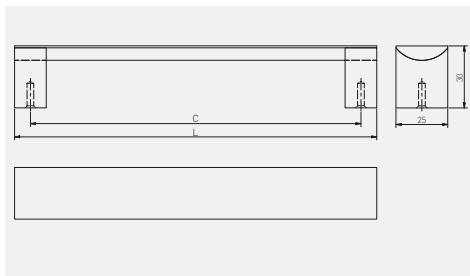

C	L	hliník, hliník, aluminium, aluminu	hliník, hliník, aluminium, aluminu
96	158	UA-00-319096	hliník, hliník, aluminium, aluminu
128	189	UA-00-319128	
160	231	UA-00-319160	





Úchytka UA-B337  
 Úchytka UA-B337  
 Fogantyú UA-B337  
 Mâner UA-B337

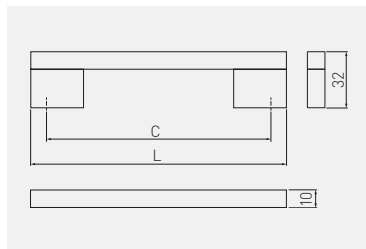

 C mm	 L mm		
		hliník, hliník, aluminium, aluminu	hliník, hliník, aluminium, aluminu
128	143	UA-B0-337128	
160	175	UA-B0-337160	
192	207	UA-B0-337192	
224	239	UA-B0-337224	
256	271	UA-B0-337256	
320	335	UA-B0-337320	

Úchytka UA-18  
 Úchytka UA-18  
 Fogantyú UA-18  
 Mâner UA-18



 C mm	 L mm		
		hliník, hliník, aluminium, aluminu	hliník, hliník, aluminium, aluminu
128	146	UA-18-128146	
160	178	UA-18-160178	
192	210	UA-18-192210	
224	242	UA-18-224242	
256	274	UA-18-256274	
320	338	UA-18-320338	

Úchytka UA-313  
 Úchytka UA-313  
 Fogantyú UA-313  
 Mâner UA-313

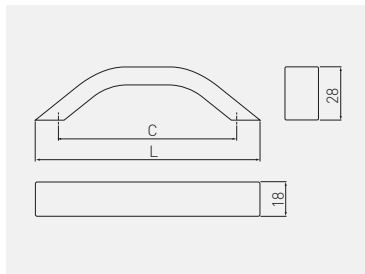

C mm	L mm		
128	150	hliník, hliník, aluminium, aluminiu	hliník, hliník, aluminium, aluminiu
160	182	UA-00-313128	
192	214	UA-00-313160	

Úchytka THIN  
 Úchytka THIN  
 Fogantyú THIN  
 Mâner THIN

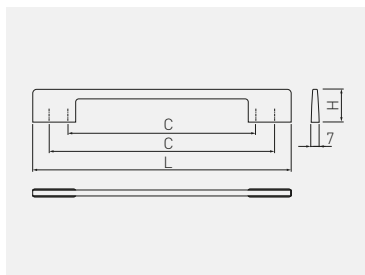

C mm	L mm	H mm				
96/128	156	24	chrom, chróm, króm, crom	hliník, hliník, aluminium, aluminiu	kartáčovaná oceľ, kartáčovaná oceľ, szálcsiszolt acél, oţel periat	ZnAl
160/192	220	28	UZ-TH096128-01	UZ-TH096128-05	UZ-TH096128-06	
			UZ-TH160192-01	UZ-TH160192-05	UZ-TH160192-06	
			UZ-TH288320-01	-	UZ-TH288320-06	

Úchytka TIVOLI  
 Úchytka TIVOLI  
 Fogantyú TIVOLI  
 Mâner TIVOLI

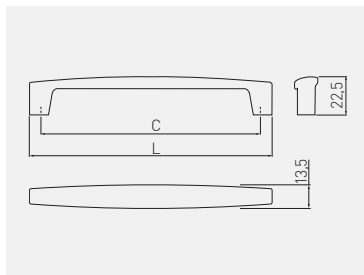

C mm	L mm				
		chrom, chróm, króm, crom	černá chrom čierna chróm fekete króm negru crom	titan titán titán titan	ZnAl
192	206	UZ-TIVOL-192-01	UZ-TIVOL-192-12	UZ-TIVOL-192-13	
320	334	UZ-TIVOL-320-01	UZ-TIVOL-320-12	UZ-TIVOL-320-13	

Úchytka ANCONA  
 Úchytka ANCONA  
 Fogantyú ANCONA  
 Mâner ANCONA

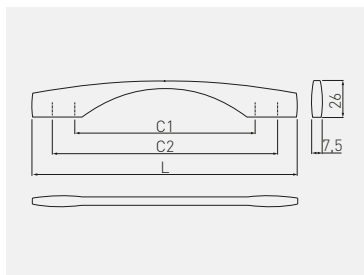

C1 mm	C2 mm	L mm			
			chrom, chróm, króm, crom	hliník, hlínik, aluminium, aluminíu	kartáčovaná oceľ, kartáčovaná oceľ, szálciszott acél, oțel periat
128	160	190	UZ-ANCON-128-01	UZ-ANCON-128-05	UZ-ANCON-128-06
192	224	254	UZ-ANCON-192-01	UZ-ANCON-192-05	UZ-ANCON-192-06
256	288	318	UZ-ANCON-256-01	UZ-ANCON-256-05	UZ-ANCON-256-06

Úchytka CLEO  
 Úchytka CLEO  
 Fogantyú CLEO  
 Mâner CLEO

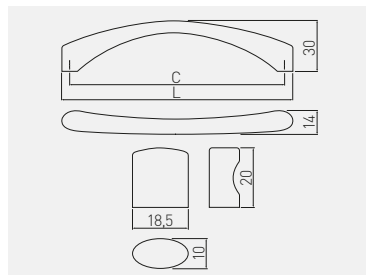

C  
mm

L  
mm



C	L				
128	137	chrom, chróm, króm, crom	hliník, hliník, aluminium, aluminu	kartáčovaná ocel, kartáčovaná ocel, szálciszott acél, ojel periat	ZnAl
160	169	UZ-CLEO-128-01	UZ-CLEO-128-05	UZ-CLEO-128-06	
192	201	UZ-CLEO-160-01	UZ-CLEO-160-05	UZ-CLEO-160-06	
		UZ-CLEO-192-01	UZ-CLEO-192-05	UZ-CLEO-192-06	

Úchytka NORD  
 Úchytka NORD  
 Fogantyú NORD  
 Mâner NORD

NEW

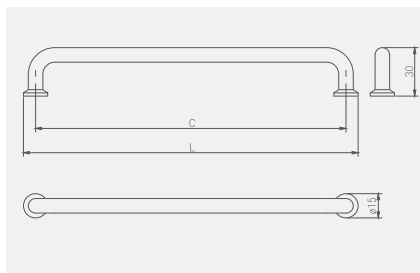

C  
mm

L  
mm



C	L				
128	146	mosaz, mosadz, sárgaréz, alamâ	kartáčované zlato, kartáčované zlato, szálciszott arany, aur periat	černá matná, čierná matná, fekete matt, negru mat	ZnAl
160	174,5	UZ-NORD-128-03	UZ-NORD-128-18	UZ-NORD-128-20M	
192	212	UZ-NORD-160-03	UZ-NORD-160-18	UZ-NORD-160-20M	
320	334	UZ-NORD-192-03	UZ-NORD-192-18	UZ-NORD-192-20M	
Knopka Knopka Gomb fogantyú Buton		UZ-NORD-320-03	UZ-NORD-320-18	UZ-NORD-320-20M	
		GZ-NORD-1-03	GZ-NORD-1-18	GZ-NORD-1-20M	



Úchytka VENICE  
 Úchytka VENICE  
 Fogantyú VENICE  
 Mâner VENICE

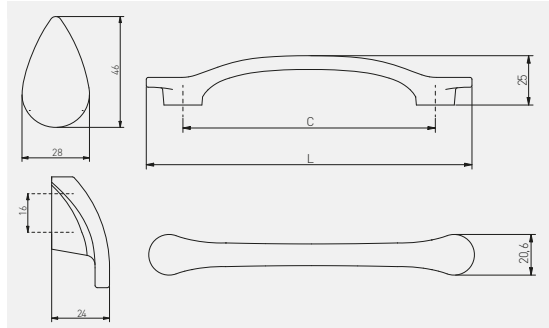

C mm	L mm			
		šampaňská šampaňská pezsgő sampanie	černá matná, čierna matná, fekete matt, negru mat	ZnAl
128	165	UZ-VENICE-128-90	UZ-VENICE-128-20M	
Knopka Knopka Gomb fogantyú Buton		GZ-VENICE-1-90	GZ-VENICE-1-20M	





Úchytka FABRICIO  
 Úchytka FABRICIO  
 Fogantyú FABRICIO  
 Mâner FABRICIO

NEW

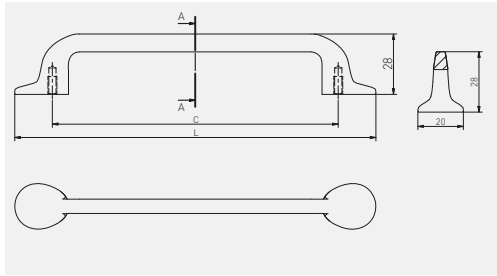

C mm	L mm				
		mosaz, mosadz, sárgaréz, alámă	kartáéované zláto, kartáéované zláto, szálciszolt arany, aur periat	éerná matná, éierna matná, fekete matt, negru mat	ZnAl
128	161	UZ-FABRICIO-128-03	UZ-FABRICIO-128-18	UZ-FABRICIO-128-20M	
192	225	UZ-FABRICIO-192-03	UZ-FABRICIO-192-18	UZ-FABRICIO-192-20M	
320	353	UZ-FABRICIO-320-03	UZ-FABRICIO-320-18	UZ-FABRICIO-320-20M	

CLASSIC



Knopka RING  
 Knopka RING  
 Gomb fogantyú RING  
 Buton RING

SHAPE ART

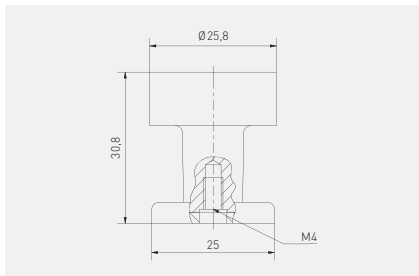

 C mm				
	kartáčovaná ocel, kartáčovaná ocel, szálcsiszolt acél, ořel periat	kartáčované zlato, kartáčované zlato, szálcsiszolt arany, aur periat	černá matná, čierna matná, fekete matt, negru mat	ZnAl
Knopka Knopka Gomb fogantyú Buton	GZ-RING-1-06	GZ-RING-1-18	GZ-RING-1-20M	



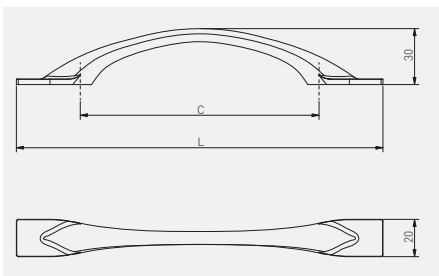

Úchytka FLOW  
 Úchytka FLOW  
 Fogantyú FLOW  
 Mâner FLOW

NEW



SHAPE ART

C mm	L mm			
128	200	kartáčovaná oceľ, kartáčovaná oceľ, szálcsiszolt acél, ojet periat	šampaňská šampaňská pezsgő sámpanie	černá matná, čierna matná, fekete matt, negru mat
128	200	UZ-FLOW-128-06	UZ-FLOW-128-90	UZ-FLOW-128-20M
192	270	UZ-FLOW-192-06	UZ-FLOW-192-90	UZ-FLOW-192-20M
ZnAl				



Úchytka OTTO  
 Úchytka OTTO  
 Fogantyú OTTO  
 Mâner OTTO

NEW

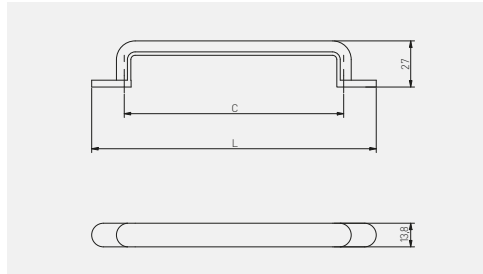

C mm	L mm				
		kartáčovaná oceľ, kartáčovaná oceľ, szálcsiszolt acél, ojet periat	šampaňská šampaňská pezsgő sámpanie	černá matná, čierna matná, fekete matt, negru mat	ZnAl
128	166	UZ-OTTO-128-06	UZ-OTTO-128-90	UZ-OTTO-128-20M	
160	198	UZ-OTTO-160-06	UZ-OTTO-160-90	UZ-OTTO-160-20M	



Úchytka EVER  
 Úchytka EVER  
 Fogantyú EVER  
 Mâner EVER

NEW

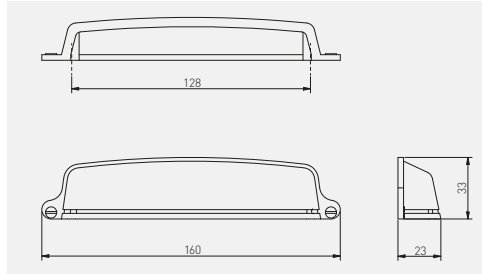

C mm	L mm			
		šampaňská šampaňská pezsgő sampanie	černá matná, čierna matná, fekete matt, negru mat	ZnAl
128	160	UZ-EVER-128-90	UZ-EVER-128-20M	

CLASSIC



Knopka POINT  
Knopka POINT  
Gomb fogantyú POINT  
Buton POINT

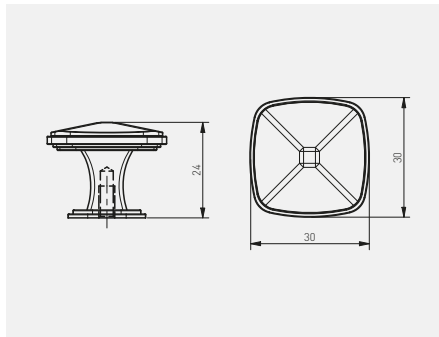

CLASSIC



	kartáčovaná oceľ, kartáčovaná oceľ, szálcsiszolt acél, ojet periat	kartáčované zlato, kartáčované zlato, szálcsiszolt arany, aur periat	černá matná, čierna matná, fekete matt, negru mat	
<b>Knopka Knopka Gomb fogantyú Buton</b>	GZ-POINT-1-06	GZ-POINT-1-18	GZ-POINT-1-20M	ZnAl



Knopka LORENA  
 Knopka LORENA  
 Gomb fogantyú LORENA  
 Buton LORENA

NEW

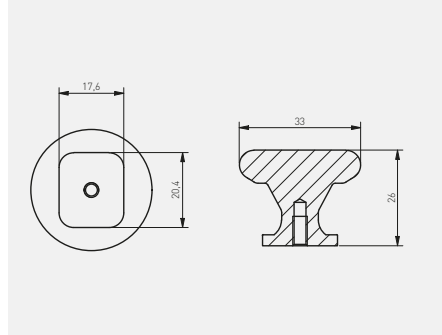

CLASSIC



	mosaz, mosadz, sárgaréz, alámá	kartáčované zlato, kartáčované zlato, szálciszolt arany, aur periat	černá matná, čierna matná, fekete matt, negru mat	antracitová, antracitová, csiszolt antracit, antracit periat	
<b>Knopka Knopka Gomb fogantyú Buton</b>	GZ-LORENA-1-03	GZ-LORENA-1-18	GZ-LORENA-1-20M	GZ-LORENA-1-21	ZnAl



Úchytka STEP  
 Úchytka STEP  
 Fogantyú STEP  
 Mâner STEP

NEW

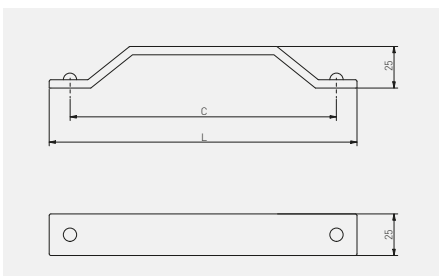

CLASSIC

C  
mm

L  
mm



		starožitné striebro starožitné striebro antik ezüst argint antic	černá matná, čierna matná, fekete matt, negru mat	ZnAl
160	185	UZ-STEP-160-07	UZ-STEP-160-20M	





Úchytka STILO  
 Úchytka STILO  
 Fogantyú STILO  
 Mâner STILO

NEW

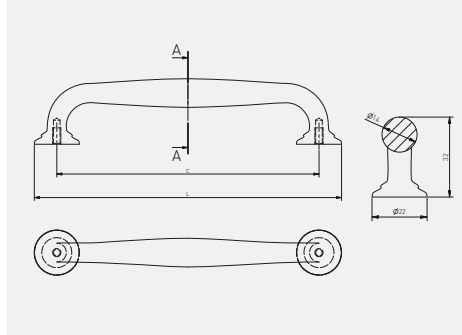

C mm	L mm			
		kartáčované zlato, kartáčované zlato, szálcsiszolt arany, aur periat	černá matná, čierna matná, fekete matt, negru mat	ZnAl
128	147	UZ-STILO-128-18	UZ-STILO-128-20M	
160	179	UZ-STILO-160-18	UZ-STILO-160-20M	
Knopka Knopka Gomb fogantyú Buton		GZ-STILO-1-18	GZ-STILO-1-20M	

CLASSIC



Úchytka CAMAIO  
 Úchytka CAMAIO  
 Fogantyú CAMAIO  
 Mâner CAMAIO

NEW

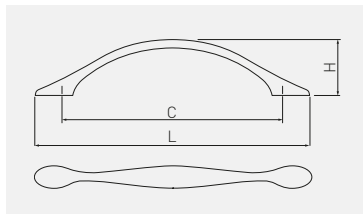

C mm	L mm	H mm	chrom, chróm, króm, crom	satén satén szatén satin	kartáčovaná ocel, kartáčovaná oceľ, szálcsiszolt acél, oţel periat	starožitná kartáčovaná mosaz, starožitná kartáčovaná mosadz, antik szálcsiszolt sárgaréz, alamá periatá antică
96	126	23	UZ-CAMAI-96-01	UZ-CAMAI-96-02	UZ-CAMAI-96-06	UZ-CAMAI-96-09
128	160	32,5	UZ-CAMAI-128-01	UZ-CAMAI-128-02	UZ-CAMAI-128-06	UZ-CAMAI-128-09



C mm	L mm	H mm	bílá matná, biela matná, fehér matt, alb mat	černá matná, čierna matná, fekete matt, negru mat	šampaňská šampaňská pezsgő sampanie	černá, chrom čierna, chróm fekete, króm negru, crom	ZnAl
96	126	23	UZ-CAMAI-96-10M	UZ-CAMAI-96-20M	UZ-CAMAI-96-90	UZ-CAMAI-96-12	
128	160	32,5	UZ-CAMAI-128-10M	UZ-CAMAI-128-20M	UZ-CAMAI-128-90	UZ-CAMAI-128-12	

CLASSIC



Knopka BERGAMO  
Knopka BERGAMO  
Gomb fogantyú BERGAMO  
Buton BERGAMO

NEW

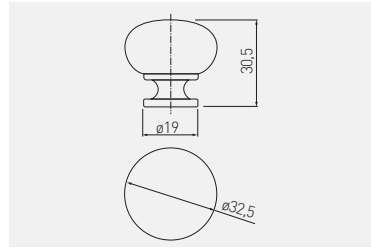

	chrom, chróm, króm, crom	satén satén szatén satin	hliník, hliník, aluminium, aluminium	kartáčovaná ocel, kartáčovaná ocel, szálciszított acél, oțel periat	ocel, ocel, acél, oțel
<b>Knopka Knopka Gomb fogantyú Buton</b>	GS-BERGA-1-01	GS-BERGA-1-02	GS-BERGA-1-05	GS-BERGA-1-06	



	bílám biela, fehér, alb	černá matná, čierna matná, fekete matt, negru mat	černá, chrom čierna, chróm fekete, króm negru, crom	šampaňská šampanská pezsgő sampanie	ocel, ocel, acél, oțel
<b>Knopka Knopka Gomb fogantyú Buton</b>	GS-BERGA-1-10	GS-BERGA-1-20M	GS-BERGA-1-12	GS-BERGA-1-90	



Knopka UDINE  
Knopka UDINE  
Gomb fogantyú UDINE  
Buton UDINE

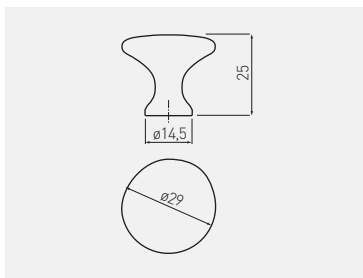

	chrom, chróm, króm, crom	satén satén szatén satin	hliník, hliník, aluminium, aluminium	kartáčovaná oceľ, kartáčovaná oceľ, szálciszolt acél, otjel periat	ZnAl
<b>Knopka Knopka Gomb fogantyú Buton</b>	GZ-UDINE-1-01	GZ-UDINE-1-02	GZ-UDINE-1-05	GZ-UDINE-1-06	



	bílá matná, biela matná, fehér matt, alb mat	černá chrom čierna chróm fekete króm negru crom	černá matná, čierna matná, fekete matt, negru mat	ZnAl
<b>Knopka Knopka Gomb fogantyú Buton</b>	GZ-UDINE-1-10M	GZ-UDINE-1-12N	GZ-UDINE-1-20M	

Knopka TERNI  
Knopka TERNI  
Gomb fogantyú TERNI  
Buton TERNI

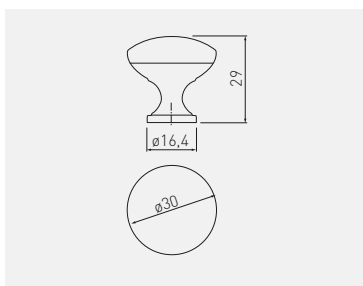

	chrom, chróm, króm, crom	satén satén szatén satin	hliník, hliník, aluminium, aluminium	kartáčovaná oceľ, kartáčovaná oceľ, szálciszolt acél, otjel periat	starožitná kartáčovaná mosaz, starožitná kartáčovaná mosadz, antik szálciszolt sárgaréz, alamá periatá anticá
<b>Knopka Knopka Gomb fogantyú Buton</b>	GZ-TERNI-1-01	GZ-TERNI-1-02	GZ-TERNI-1-05	GZ-TERNI-1-06	GZ-TERNI-1-09



	bílám biela, fehér, alb	černá chrom čierna chróm fekete króm negru crom	měď meď réz cupru	zlatá mosaz, zlatá mosadz, aranyréz, alamá aurie	černá matná, čierna matná, fekete matt, negru mat	ZnAl
<b>Knopka Knopka Gomb fogantyú Buton</b>	GZ-TERNI-1-10	GZ-TERNI-1-12	GZ-TERNI-1-15	GZ-TERNI-1-16	GZ-TERNI-1-20M	

Úchytka STRUCTURE  
 Úchytka STRUCTURE  
 Fogantyú STRUCTURE  
 Mâner STRUCTURE

NEW

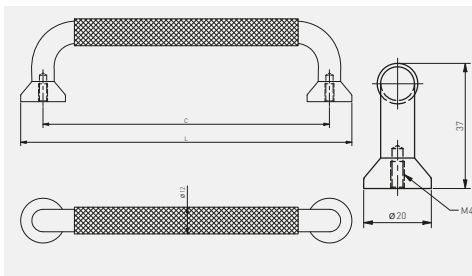

C	L		
mm	mm		
128	147	černá matná, čierna matná, fekete matt, negru mat	hliník, hliník, aluminium, aluminium
192	212	UA-STRUCTURE-192-20M	
Knopka Knopka Gomb fogantyú Buton		GA-STRUCTURE-1-20M	

CLASSIC



Úchytka G0  
 Úchytka G0  
 Fogantyú G0  
 Mâner G0

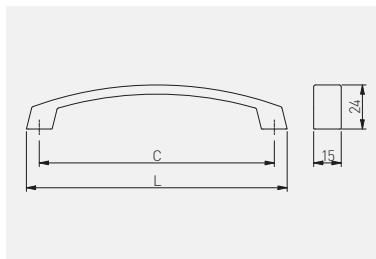

C mm	L mm				
128	142	chrom, chróm, króm, crom	hliník, hliník, aluminíum, aluminium	kartáčovaná oceľ, kartáčovaná oceľ, szálcsiszolt acél, oţel periat	ZnAl
160	174	UZ-G0-128-01	UZ-G0-128-05	UZ-G0-128-06	
192	206	UZ-G0-160-01	UZ-G0-160-05	UZ-G0-160-06	
256	270	UZ-G0-192-01	UZ-G0-192-05	UZ-G0-192-06	
		UZ-G0-256-01	UZ-G0-256-05	UZ-G0-256-06	

Úchytka UZ-G1  
 Úchytka UZ-G1  
 Fogantyú UZ-G1  
 Mâner UZ-G1

NEW

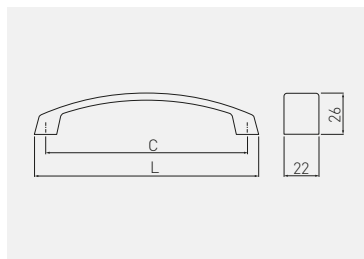

C mm	L mm						
128	142	chrom, chróm, króm, crom	hliník, hliník, aluminíum, aluminium	kartáčovaná oceľ, kartáčovaná oceľ, szálcsiszolt acél, oţel periat	titan titán titan titan	černá matná, čierna matná, fekete matt, negru mat	ZnAl
160	174	UZ-G1-128-01	UZ-G1-128-05	UZ-G1-128-06	UZ-G1-128-13	UZ-G1-128-20M	
192	206	UZ-G1-160-01	UZ-G1-160-05	UZ-G1-160-06	UZ-G1-160-13	UZ-G1-160-20M	
256	270	UZ-G1-192-01	UZ-G1-192-05	UZ-G1-192-06	UZ-G1-192-13	UZ-G1-192-20M	
320	334	UZ-G1-256-01	UZ-G1-256-05	UZ-G1-256-06	UZ-G1-256-13	UZ-G1-256-20M	
416	430	UZ-G1-320-01	UZ-G1-320-05	UZ-G1-320-06	UZ-G1-320-13	UZ-G1-320-20M	
		UZ-G1-416-01	UZ-G1-416-05	UZ-G1-416-06	-	-	

Úchytka UA-337  
 Úchytka UA-337  
 Fogantyú UA-337  
 Mâner UA-337

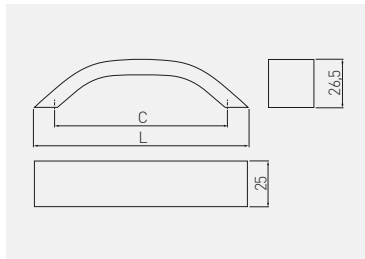

C mm	L mm			
		hliník, hliník, aluminíum, aluminíu	černá, čierna, fekete, negru	hliník, hliník, aluminíum, aluminíu
96	116	UA-00-337096	UA-00-337096-20M	
128	146	UA-00-337128	UA-00-337128-20M	
160	180	UA-00-337160	UA-00-337160-20M	
192	212	UA-00-337192	UA-00-337192-20M	
224	244	UA-00-337224	UA-00-337224-20M	
256	275	UA-00-337256	UA-00-337256-20M	
320	340	UA-00-337320	UA-00-337320-20M	

Úchytka UA-338  
 Úchytka UA-338  
 Fogantyú UA-338  
 Mâner UA-338

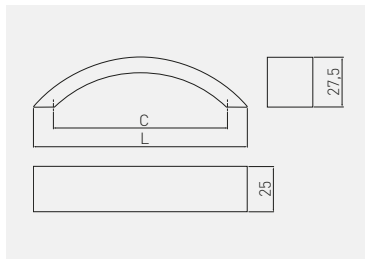

C mm	L mm			
		hliník, hliník, aluminíum, aluminíu		hliník, hliník, aluminíum, aluminíu
128	137	UA-00-338128		
160	169	UA-00-338160		

Úchytka UA-340  
 Úchytka UA-340  
 Fogantyú UA-340  
 Mâner UA-340

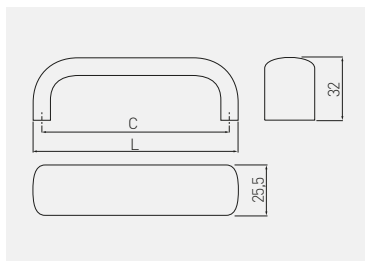

C mm	L mm		
128	137	hliník, hliník, aluminium, aluminium	hliník, hliník, aluminium, aluminium
160	169	UA-00-340128	
192	201	UA-00-340160	
224	233	UA-00-340192	
320	329	UA-00-340224	

Úchytka UA-347  
 Úchytka UA-347  
 Fogantyú UA-347  
 Mâner UA-347

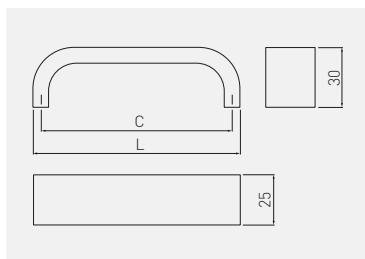

C mm	L mm		
128	136	hliník, hliník, aluminium, aluminium	hliník, hliník, aluminium, aluminium
160	168	UA-00-347128	
192	200	UA-00-347160	
224	232	UA-00-347192	
256	264	UA-00-347224	
320	328	UA-00-347256	



Úchytka CALABRIA  
 Úchytka CALABRIA  
 Fogantyú CALABRIA  
 Mâner CALABRIA

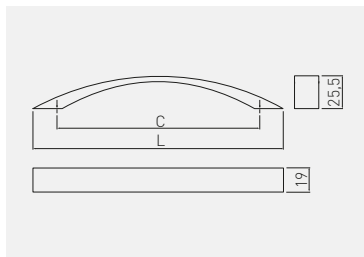

C mm	L mm				
		chrom, chróm, króm, crom	kartáčovaná oceľ, kartáčovaná oceľ, szálcsiszolt acél, oțel periat		
160	195	UZ-CALABRIA160-01	UZ-CALABRIA160-06	ZnAl	
192	224	UZ-CALABRIA192-01	UZ-CALABRIA192-06		
224	258	UZ-CALABRIA224-01	UZ-CALABRIA224-06		

Úchytka GENUA  
 Úchytka GENUA  
 Fogantyú GENUA  
 Mâner GENUA

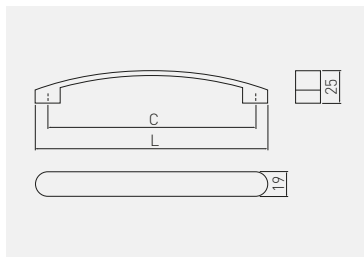

NEW

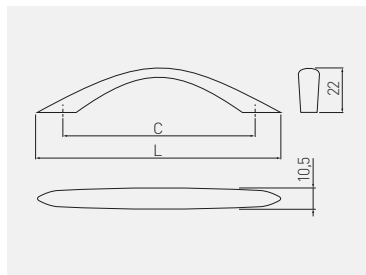

C mm	L mm					
		chrom, chróm, króm, crom	sátén sátén szatén satin	hliník, hlínik, alumínium, aluminiiu	černá matná, čierna matná, fekete matt, negru mat	
128	148	UZ-GENUA128-01	UZ-GENUA128-02	UZ-GENUA128-05	UZ-GENUA128-20M	ZnAl
160	180	UZ-GENUA160-01	UZ-GENUA160-02	UZ-GENUA160-05	UZ-GENUA160-20M	

Úchytka UZ-01  
 Úchytka UZ-01  
 Fogantyú UZ-01  
 Mâner UZ-01



C mm	L mm				
96	121	chrom, chróm, króm, crom	satén satén szatén satin	hliník, hliník, aluminium, aluminium	ZnAl
128	158	UZ-01-096-01	UZ-01-096-02	UZ-01-096-05	
		UZ-01-128-01	UZ-01-128-02	UZ-01-128-05	

Úchytka UZ-05  
 Úchytka UZ-05  
 Fogantyú UZ-05  
 Mâner UZ-05

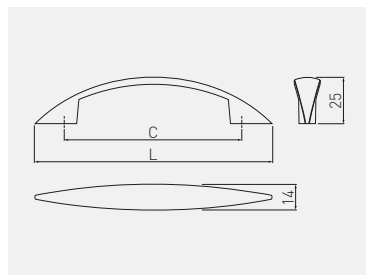

C mm	L mm				
96	132	chrom, chróm, króm, crom	satén satén szatén satin	hliník, hliník, aluminium, aluminium	ZnAl
128	164	UZ-05-096-01	UZ-05-096-02	UZ-05-096-05	
		UZ-05-128-01	UZ-05-128-02	UZ-05-128-05	



Úchytka UZ-06  
 Úchytka UZ-06  
 Fogantyú UZ-06  
 Mâner UZ-06

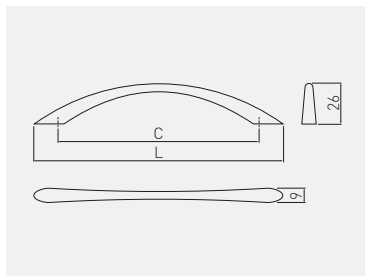

C mm	L mm				
		chrom, chróm, króm, crom	satén satén szatén satin	hliník, hliník, aluminium, aluminiiu	ZnAl
128	164	UZ-06-128-01	UZ-06-128-02	UZ-06-128-05	

Úchytka UZ-07  
 Úchytka UZ-07  
 Fogantyú UZ-07  
 Mâner UZ-07

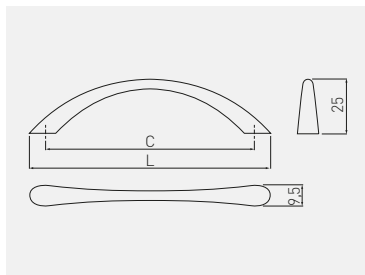

C mm	L mm				
		chrom, chróm, króm, crom	satén satén szatén satin	hliník, hliník, aluminium, aluminiiu	ZnAl
96	111	UZ-07-096-01	UZ-07-096-02	UZ-07-096-05	

Úchytka UZ-Z10  
 Úchytka UZ-Z10  
 Fogantyú UZ-Z10  
 Mâner UZ-Z10

NEW

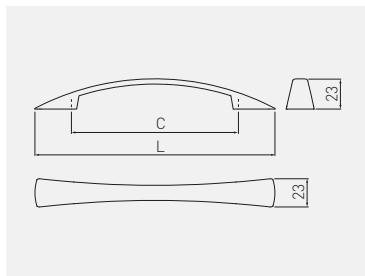

C mm	L mm					
		chrom, chróm, króm, crom	satén satén szatén satin	hliník, hliník, aluminium, aluminium	černá matná, čierna matná, fekete matt, negru mat	ZnAl
96	138	UZ-Z10096-01	UZ-Z10096-02	UZ-Z10096-05	UZ-Z10096-20M	
128	184	UZ-Z10128-01	UZ-Z10128-02	UZ-Z10128-05	UZ-Z10128-20M	

Úchytka UZ-13  
 Úchytka UZ-13  
 Fogantyú UZ-13  
 Mâner UZ-13

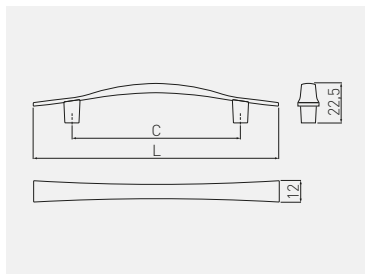

C mm	L mm					
		chrom, chróm, króm, crom	satén satén szatén satin	hliník, hliník, aluminium, aluminium		ZnAl
96	140	UZ-13-096-01	UZ-13-096-02	UZ-13-096-05		

CLASSIC

Knopka GZ-1155  
 Knopka GZ-1155  
 Gomb fogantyú GZ-1155  
 Buton GZ-1155

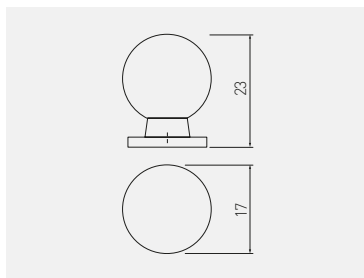

	chrom, chróm, króm, crom	ZnAl
Knopka Knopka Gomb fogantyú Buton	GZ-WP1155-01	

Knopka GZ-ZH  
 Knopka GZ-ZH  
 Gomb fogantyú GZ-ZH  
 Buton GZ-ZH

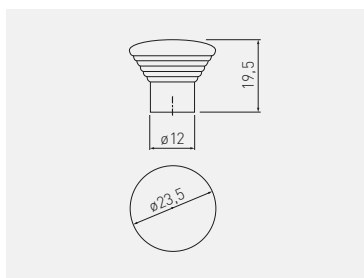

	hliník, hliník, aluminium, aluminium	ZnAl
Knopka Knopka Gomb fogantyú Buton	GZ-ZH-011-05A	



Úchytka RELING RS  
 Úchytka RELING RS  
 Fogantyú RELING RS  
 Mâner RELING RS

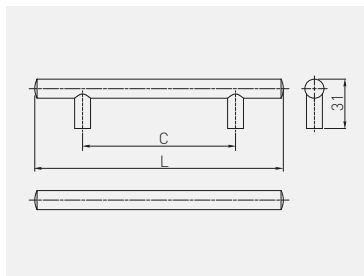

		chrom, chróm, króm, crom	satén satén szatén satin	hliník, hliník, aluminium, aluminium	kartáčovaná ocel, kartáčovaná ocel, szálciszolt acél, oțel periat	starožitná měď, starožitná měď, antik réz, cupru antic	
96	156	RS-156096-01	RS-156096-02	RS-156096-05	RS-156096-06	RS-156096-14	
128	188	RS-188128-01	RS-188128-02	RS-188128-05	RS-188128-06	RS-188128-14	
160	220	RS-220160-01	RS-220160-02	RS-220160-05	RS-220160-06	RS-220160-14	ocel, ocel, acél, oțel
192	272	RS-272192-01	RS-272192-02	RS-272192-05	RS-272192-06	RS-272192-14	
224	304	RS-304224-01	RS-304224-02	RS-304224-05	RS-304224-06	RS-304224-14	
256	336	RS-336256-01	RS-336256-02	RS-336256-05	RS-336256-06	RS-336256-14	
288	368	RS-368288-01	RS-368288-02	RS-368288-05	RS-368288-06	RS-368288-14*	
320	400	RS-400320-01	RS-400320-02	RS-400320-05	RS-400320-06	RS-400320-14	



		kartáčovaná ocel, kartáčovaná ocel, szálciszolt acél, oțel periat	černá matná, čierna matná, fekete matt, negru mat	
96	156	-	ID-RS-E-15696-20M*	ocel, ocel, acél, oțel
128	188	-	ID-RS-E-188128-20M*	
160	220	ID-RS-E-220160-06*	ID-RS-E-220160-20M*	
192	272	ID-RS-E-272192-06*	ID-RS-E-272192-20M*	
224	304	ID-RS-E-304224-06*	ID-RS-E-304224-20M*	
256	336	ID-RS-E-336256-06*	ID-RS-E-336256-20M*	
288	368	ID-RS-E-368288-06*	ID-RS-E-368288-20M*	
320	400	ID-RS-E-400320-06*	ID-RS-E-400320-20M*	

Pro speciální objednávky jsou k dispozici další velikosti: 352, 384, 416, 480, 512, 544, 576, 608, 640, 672, 704, 736, 768, 800 [mm].

Na speciálne objednávky sú k dispozícii ďalšie veľkosti: 352, 384, 416, 480, 512, 544, 576, 608, 640, 672, 704, 736, 768, 800 [mm].

Külön megrendelésben további méretek állnak rendelkezésre: 352, 384, 416, 480, 512, 544, 576, 608, 640, 672, 704, 736, 768, 800 [mm].

Alte dimensiuni sunt disponibile pentru comenzi speciale: 352, 384, 416, 480, 512, 544, 576, 608, 640, 672, 704, 736, 768, 800 [mm].



starožitná měď,  
starožitná měď,  
antik réz,  
cupru antic

\*K dispozici pro speciální objednávky / K dispozícii na speciálne objednávky / Külön megrendelésben kapható / Disponibil pentru comenzi speciale

Ďalší rozteče a barvy lze zakoupit na individuální objednávku / Ďalšie rozteče a farby možnosť zakúpiť na individuálnu objednávku / További távolságok és színek egyedi megrendelésre megvásárolhatók / Spațțiile și culorile suplimentare pot fi achiziționate la comandă individuală





Úchytka TRIEST  
 Úchytka TRIEST  
 Fogantyú TRIEST  
 Mâner TRIEST

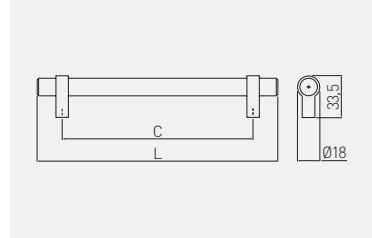





C mm	L mm		
96	136	kartáčovaná oceľ, kartáčovaná oceľ, szálciszottlított acél, oțel periat	ZnAl + ocel ZnAl + ocel ZnAl + acét ZnAl + oțel
128	168	RS-TRIES-128-06	
160	200	RS-TRIES-160-06	
192	232	RS-TRIES-192-06	
256	296	RS-TRIES-256-06	
320	360	RS-TRIES-320-06	

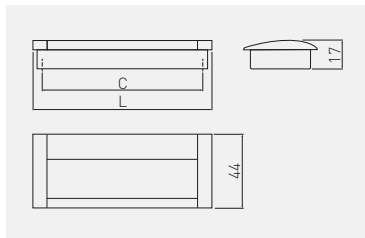

Úchytka UA-326  
 Úchytka UA-326  
 Fogantyú UA-326  
 Mâner UA-326







 C mm	 L mm				
		hliník, chrom hliník, chróm aluminium, króm aluminium, crom	hliník, hliník, aluminium, aluminium	černá, čierna, fekete, negru	hliník, hliník, aluminium, aluminium
96	108	UA-01-326096-V1	UA-00-326096-05	UA-00-326096-20M	
128	140	UA-01-326128-V1	UA-00-326128-05	UA-00-326128-20M	
160	172	UA-01-326160	UA-00-326160	UA-00-326160-20M	

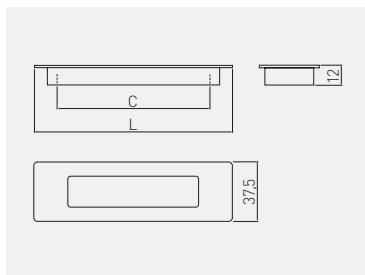

Úchytka UZ-E6  
 Úchytka UZ-E6  
 Fogantyú UZ-E6  
 Mâner UZ-E6



 C mm	 L mm				
		chrom, chróm, króm, crom	hliník, hlíník, aluminium, aluminíu	kartiáčovaná oceľ, kartiáčovaná oceľ, szálciszított acél, oțel periat	ZnAl
96	124	UZ-E6-096-01	UZ-E6-096-05	UZ-E6-096-06	
128	155	UZ-E6-128-01	UZ-E6-128-05	UZ-E6-128-06	
160	186	UZ-E6-160-01	UZ-E6-160-05	UZ-E6-160-06	



Úchytka B224  
 Úchytka B224  
 Fogantyú B224  
 Mâner B224

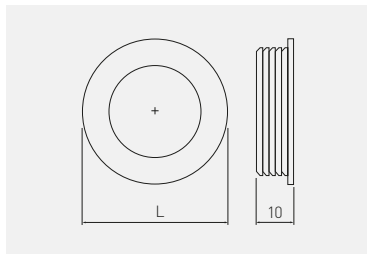

L mm						ZnAl
40,5	chrom, chróm, króm, crom	satén satén szatén satén	hliník, hliník, aluminíum, aluminíu	bílám biela, fehér, alb	černá, čierna, fekete, negru	



Úchytka B226  
 Úchytka B226  
 Fogantyú B226  
 Mâner B226

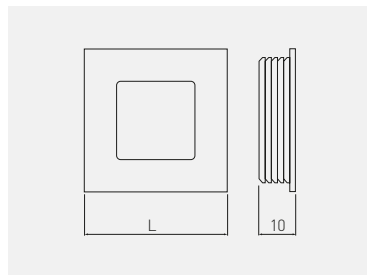
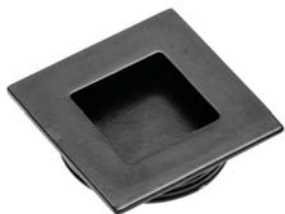

mm



	chrom, chróm, króm, crom	satén satén szatén satín	hliník, hliník, aluminium, aluminium	bílám biela, fehér, alb	černá, čierna, fekete, negru	ZnAl
40	UZ-00B226-01	UZ-00B226-02	UZ-00B226-05	UZ-00B226-10	UZ-00B226-20	

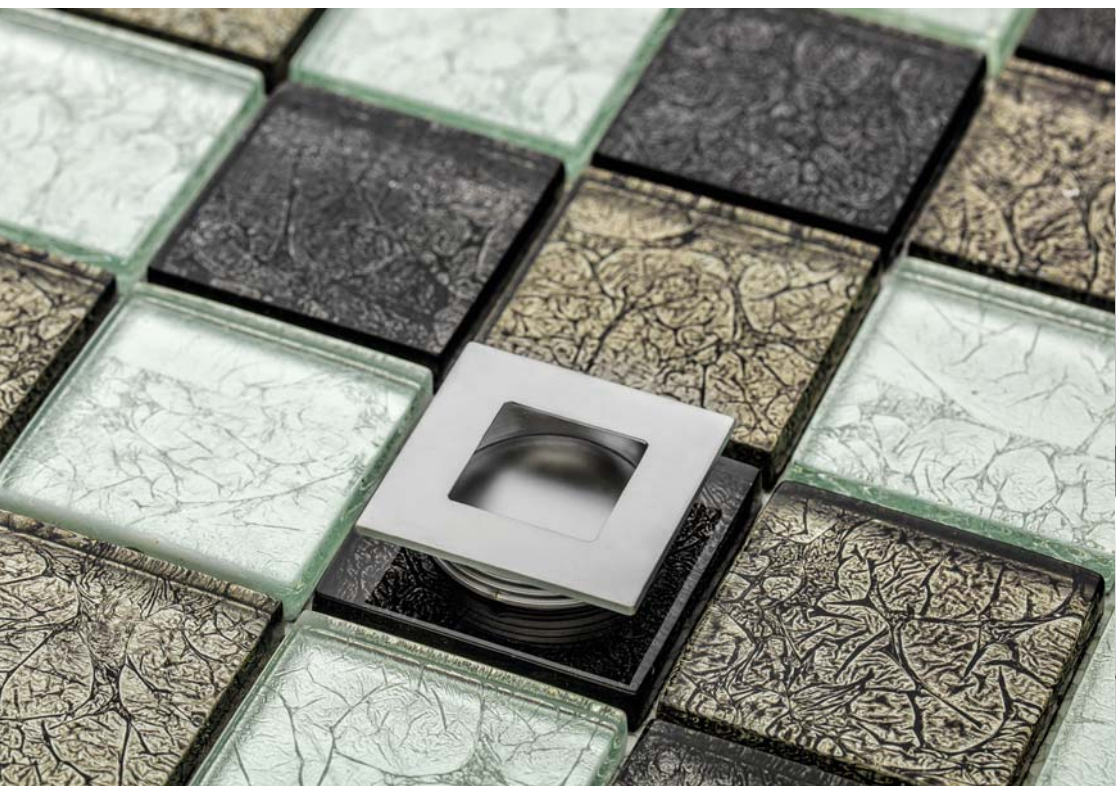

Úchytka LIND  
 Úchytka LIND  
 Fogantyú LIND  
 Mâner LIND

NEW

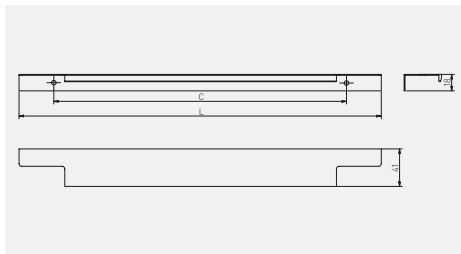

EDGE MOUNTED

 C  
mm

 L  
mm



		chrom, chróm, króm, crom	hliník, hliník, aluminium, aluminium	kartáčované zlato, kartáčované zlato, szálcsiszolt arany, aur periat	černá matná, čierna matná, fekete matt, negru mat	
<b>128</b>	<b>150</b>	UA-LIND-150-128-01	UA-LIND-150-128-05	UA-LIND-150-128-18	UA-LIND-150-128-20M	hliník, hliník, aluminium, aluminium
<b>256</b>	<b>296</b>	UA-LIND-256-296-01	UA-LIND-256-296-05	UA-LIND-256-296-18	UA-LIND-256-296-20M	
<b>320</b>	<b>396</b>	UA-LIND-320-396-01	UA-LIND-320-396-05	UA-LIND-320-396-18	UA-LIND-320-396-20M	
<b>2 x 224*</b>	<b>496</b>	UA-LIND-224-496-01	UA-LIND-224-496-05	UA-LIND-224-496-18	UA-LIND-224-496-20M	
<b>2 x 256*</b>	<b>596</b>	UA-LIND-256-596-01	UA-LIND-256-596-05	UA-LIND-256-596-18	UA-LIND-256-596-20M	
<b>2 x 352*</b>	<b>796</b>	UA-LIND-352-796-01	UA-LIND-352-796-05	UA-LIND-352-796-18	UA-LIND-352-796-20M	





\*Montáž pomocí 3 šroubů / Montáž pomocou 3 skrutiek / 3 csavarral van szerelve / Montat cu 3 șuruburi

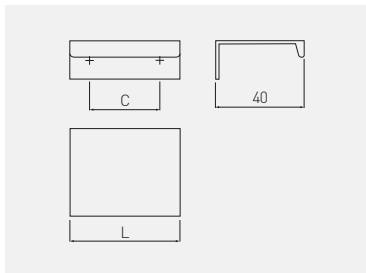





Úchytka HEXI  
 Úchytka HEXI  
 Fogantyú HEXI  
 Mâner HEXI

NEW



 C mm	 L mm				
		chrom, chróm, króm, crom	hliník, hlinik, aluminium, aluminium	bilá matná, biela matná, fehér matt, alb mat	černá matná, čierna matná, fekete matt, negru mat
<b>32</b>	<b>50</b>	UA-HEXI-01	UA-HEXI-05	UA-HEXI-10M	UA-HEXI-20M
<b>96</b>	<b>150</b>	UA-HEXI96-01	UA-HEXI96-05	UA-HEXI96-10M	UA-HEXI96-20M
<b>128</b>	<b>150</b>	UA-HEXI-128-01	UA-HEXI-128-05	UA-HEXI-128-10M	UA-HEXI-128-20M
<b>160</b>	<b>190</b>	UA-HEXI-160-01	UA-HEXI-160-05	UA-HEXI-160-10M	UA-HEXI-160-20M
<b>192</b>	<b>225</b>	UA-HEXI192-01	UA-HEXI192-05	UA-HEXI192-10M	UA-HEXI192-20M
<b>256</b>	<b>290</b>	UA-HEXI-256-01	UA-HEXI-256-05	UA-HEXI-256-10M	UA-HEXI-256-20M
<b>320</b>	<b>360</b>	UA-HEXI-320-01	UA-HEXI-320-05	UA-HEXI-320-10M	UA-HEXI-320-20M
<b>pro řezání na rezanie vágáshoz pentru tăiere</b>	<b>3500</b>	-	UA-HEXI-3500-05	-	UA-HEXI-3500-20M

 C mm	 L mm				
		antracitová, antracitová, antracit, antracit	kartáčované zlato, kartáčované zlato, szálcsiszolt arany, aur periat		
<b>32</b>	<b>50</b>	UA-HEXI-60	UA-HEXI-18		
<b>96</b>	<b>150</b>	UA-HEXI96-60	UA-HEXI96-18		
<b>160</b>	<b>190</b>	UA-HEXI-160-60	UA-HEXI-160-18		
<b>192</b>	<b>225</b>	UA-HEXI192-60	UA-HEXI192-18		
<b>256</b>	<b>290</b>	UA-HEXI-290-60	UA-HEXI-290-18		
<b>320</b>	<b>360</b>	UA-HEXI-360-60	UA-HEXI-360-18		









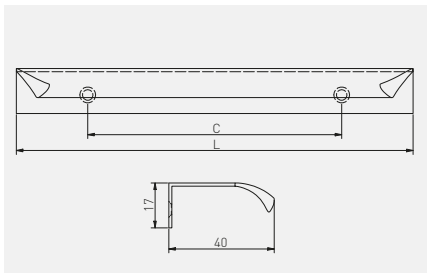





Úchytka HEXA  
 Úchytka HEXA  
 Fogantyú HEXA  
 Mâner HEXA

NEW



					
		chrom, chróm, króm, crom	hliník, hlinik, aluminium, aluminium	bílá matná, biela matná, fehér matt, alb mat	 hliník, hlinik, aluminium, aluminium
32	50	UA-HEXA-32-01	UA-HEXA-32-05	UA-HEXA-32-10M	
96	150	UA-HEXA-96-01	UA-HEXA-96-05	UA-HEXA-96-10M	
160	193	UA-HEXA-160-01	UA-HEXA-160-05	UA-HEXA-160-10M	
192	225	UA-HEXA-192-01	UA-HEXA-192-05	UA-HEXA-192-10M	
256	266	UA-HEXA-256-01	UA-HEXA-256-05	UA-HEXA-256-10M	
320	353	UA-HEXA-320-01	UA-HEXA-320-05	UA-HEXA-320-10M	

					
		kartáčované zlato, kartáčované zlato, szálcsiszolt arany, aur perlat	černá matná, čierna matná, fekete matt, negru mat	zlato, zlato, arany, aur	 hliník, hlinik, aluminium, aluminium
32	50	UA-HEXA-32-18	UA-HEXA-32-20M	UA-HEXA-32-22	
96	150	UA-HEXA-96-18	UA-HEXA-96-20M	UA-HEXA-96-22	
160	193	-	UA-HEXA-160-20M	UA-HEXA-160-22	
192	225	UA-HEXA-192-18	UA-HEXA-192-20M	UA-HEXA-192-22	
256	266	-	UA-HEXA-256-20M	UA-HEXA-256-22	
320	353	-	UA-HEXA-320-20M	UA-HEXA-320-22	



Úchytka PICADO  
 Úchytka PICADO  
 Fogantyú PICADO  
 Mâner PICADO

NEW

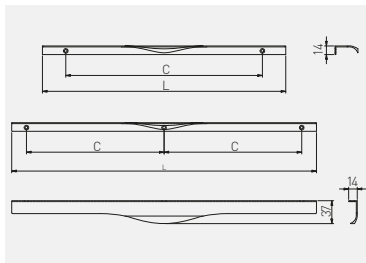

C  
mm

L  
mm



C mm	L mm	chrom, chróm, króm, crom	hliník, hliník, aluminium, aluminu	hliník, hliník, aluminium, aluminu
256	296	UA-PICADO-256-296-01	UA-PICADO-256-296-05	
320	396	UA-PICADO-320-396-01	UA-PICADO-320-396-05	
2 x 224*	496	UA-PICADO-224-496-01	UA-PICADO-224-496-05	
2 x 256*	596	UA-PICADO-256-596-01	UA-PICADO-256-596-05	
2 x 352*	796	UA-PICADO-352-796-01	UA-PICADO-352-796-05	

C  
mm

L  
mm



C mm	L mm	kartáčované zlato, kartáčované zlato, szálciszolt arany, aur periat	černá matná, čierna matná, fekete matt, negru mat	hliník, hliník, aluminium, aluminu
256	296	UA-PICADO-256-296-18	UA-PICADO-256-296-20M	
320	396	UA-PICADO-320-396-18	UA-PICADO-320-396-20M	
2 x 224*	496	UA-PICADO-224-496-18	UA-PICADO-224-496-20M	
2 x 256*	596	UA-PICADO-256-596-18	UA-PICADO-256-596-20M	
2 x 352*	796	UA-PICADO-352-796-18	UA-PICADO-352-796-20M	

\*Montáž pomocí 3 šroubů / Montáž pomocou 3 skrutiek / 3 csavarral van szerelve / Montat cu 3 șuruburi



Úchytka FIORD  
 Úchytka FIORD  
 Fogantyú FIORD  
 Mâner FIORD



NEW

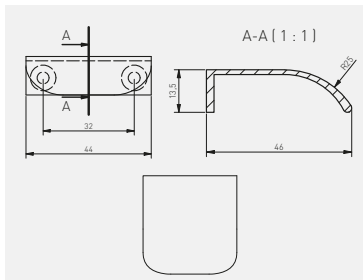

	mosaz, mosadz, sárgaréz, alámă	hliník, hliník, aluminium, aluminu	kartáčovaná ocel, kartáčovaná oceľ, szálcsiszolt acél, oțel periat	zlatá mosaz, zlatá mosadz, aranyrész, alámă aurie	
<b>Knopka Knopka Gomb fogantyú Buton</b>	UZ-FIORD-32-03	UZ-FIORD-32-05	UZ-FIORD-32-06	UZ-FIORD-32-16	ZnAl



	kartáčované zlato, kartáčované zlato, szálcsiszolt arany, aur periat	kartáčovaná ocel, kartáčovaná oceľ, szálcsiszolt acél, oțel periat	bílám biela, fehér, alb	černá matná, čierna matná, fekete matt, negru mat	
<b>Knopka Knopka Gomb fogantyú Buton</b>	UZ-FIORD-32-18	UZ-FIORD-32-06	UZ-FIORD-32-10	UZ-FIORD-32-20M	ZnAl

Úchytka TREX  
 Úchytka TREX  
 Fogantyú TREX  
 Mâner TREX

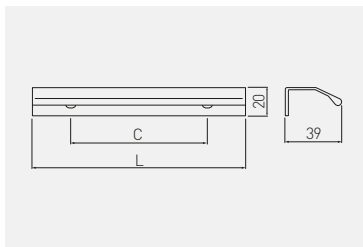

C  
mm

L  
mm





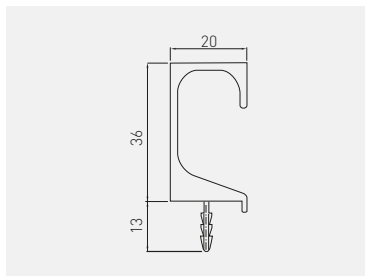

		hliník, hliník, aluminium, aluminu	černá matná, čierna matná, fekete matt, negru mat	hliník, hliník, aluminium, aluminu
<b>32</b>	<b>50</b>	UA-TREX-32-50-05	UA-TREX-32-50-20M	
<b>96</b>	<b>150</b>	UA-TREX-96-150-05	UA-TREX-96-150-20M	
<b>224</b>	<b>250</b>	UA-TREX-224-250-05	UA-TREX-224-250-20M	
<b>320</b>	<b>350</b>	UA-TREX-320-350-05	UA-TREX-320-350-20M	
<b>pro řezání na rezanie vágáshoz pentru tăiere</b>	<b>3500</b>	UA-TREX-3500-05	UA-TREX-3500-20M	

Úchytka PROFIL C  
 Úchytka PROFIL C  
 Fogantyú PROFIL C  
 Mâner PROFIL C



EDGE MOUNTED

 C mm	 L mm		
pro řezání na rezanie vágáshoz pentru tăiere	3500	hliník, hliník, aluminium, aluminium	kartáčovaná ocel, kartáčovaná ocel, szálcsiszolt acél, oțel periat
			černá matná, čierna matná, fekete matt, negru mat
			
			hliník, hliník, aluminium, aluminium
			PA-0242-35-50
			PA-0242-35-50-06
			PA-0242-35-50-20M



Úchytka PROFIL L  
 Úchytka PROFIL L  
 Fogantyú PROFIL L  
 Mâner PROFIL L

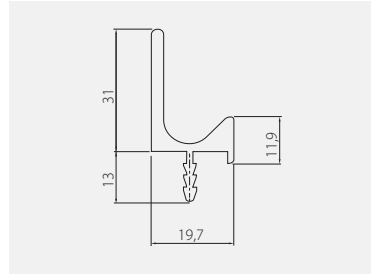

C mm	L mm				
pro řezání na rezanie vágáshoz pentru tăiere	3500	hliník, hliník, aluminium, aluminium	kartáčovaná ocel, kartáčovaná ocel, szálciszott acél, oțel periat	černá matná, čierna matná, fekete matt, negru mat	hliník, hliník, aluminium, aluminium



Bezúchytkový systém VELLO  
 Bezúchytkový systém VELLO  
 VELLO rejtett fogantyú profil  
 Sistem fără mâner VELLO

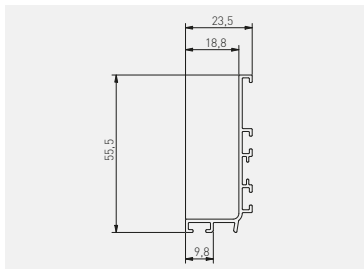

	C mm	L mm			
			hliník, hliník, aluminium, aluminium	kartáčovaná oceľ, kartáčovaná oceľ, szálcsiszolt acél, oţel periat	bílám biela, fehér, alb
pro řezání na rezanie vágáshoz pentru tăiere	3000		PA-VELLO-L3M-05	PA-VELLO-L3M-06	PA-VELLO-L3M-10
	4100		PA-VELLO-L4M-05	PA-VELLO-L4M-06	PA-VELLO-L4M-10

	C mm	L mm			
			černá matná, čierna matná, fekete matt, negru mat	zlato, zlato, arany, aur	hliník, hliník, aluminium, aluminium
pro řezání na rezanie vágáshoz pentru tăiere	3000		PA-VELLO-L3M-20M	-	
	4100		PA-VELLO-L4M-20M	PA-VELLO-L4M-21	

Přístušenství / Doplnky / Kiegészítők / Accesorii



Kryty / Kryty / Borítók / Huse



PA-ZASVELLO-LNL-20M

PA-ZASVELLO-LNP-20M

PA-ZASVELLO-LPL-20M

PA-ZASVELLO-LPP-20M

PA-OSMLGLAXMIC3M-00N

hliník, hliník, aluminium, aluminium	kartáčovaná oceľ, kartáčovaná oceľ, szálcsiszolt acél, oţel periat	bílám biela, fehér, alb	
PA-ZASVELLO-LNL-05	PA-ZASVELLO-LNL-06	PA-ZASVELLO-LNL-10	plast, plast, műanyag, plastic
PA-ZASVELLO-LNP-05	PA-ZASVELLO-LNP-06	PA-ZASVELLO-LNP-10	
PA-ZASVELLO-LPL-05	PA-ZASVELLO-LPL-06	PA-ZASVELLO-LPL-10	
PA-ZASVELLO-LPP-05	PA-ZASVELLO-LPP-06	PA-ZASVELLO-LPP-10	

černá matná, čierna matná, fekete matt, negru mat	zlato, zlato, arany, aur	
PA-ZASVELLO-LNL-20M	PA-ZASVELLO-LNL-21	plast, plast, műanyag, plastic
PA-ZASVELLO-LNP-20M	PA-ZASVELLO-LNP-21	
PA-ZASVELLO-LPL-20M	PA-ZASVELLO-LPL-21	
PA-ZASVELLO-LPP-20M	PA-ZASVELLO-LPP-21	



PA-MOUNT-GL-00

Možnost použítí LED osvětlení. Doporučený kryt PA-OSMLGLAXMIC3M-00N

Možnost použitia LED osvetlenia. Odporúčaný kryt PA-OSMLGLAXMIC3M-00N

LED világítás használatának lehetősége. Ajánlott PA-OSMLGLAXMIC3M-00N borítók

Posibilitatea utilizării iluminatului cu LED-uri. Capac recomandată PA-OSMLGLAXMIC3M-00N





Bezúchytkový systém VELLO  
 Bezúchytkový systém VELLO  
 VELLO rejtett fogantyú profil  
 Sistem fără mâner VELLO

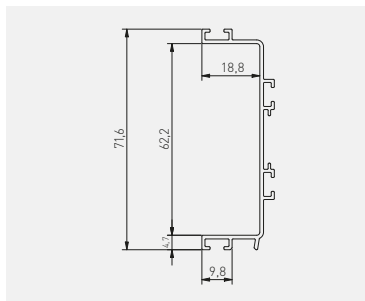

	C mm	L mm			
			hliník, hliník, aluminium, aluminium	kartáčovaná oceľ, kartáčovaná oceľ, szálcsiszolt acél, oţel periat	bílám biela, fehér, alb
pro řezání na rezanie vágáshoz pentru tăiere	3000		PA-VELLO-C3M-05	PA-VELLO-C3M-06	PA-VELLO-C3M-10
	4100		PA-VELLO-C4M-05	PA-VELLO-C4M-06	PA-VELLO-C4M-10

	C mm	L mm			
			černá matná, čierna matná, fekete matt, negru mat	zlato, zlato, arany, aur	hliník, hliník, aluminium, aluminium
pro řezání na rezanie vágáshoz pentru tăiere	3000		PA-VELLO-C3M-20M	-	
	4100		PA-VELLO-C4M-20M	PA-VELLO-C4M-21	

Příslušenství / Doplnky / Kiegészítők / Accesorii

Kryty / Kryty / Borítók / Huse



PA-ZASVELLO-CN-20M



PA-ZASVELO-CP-20M



PA-MOUNT-GL-00



PA-OSMLGLAXMIC3M-00N

	hliník, hliník, aluminium, aluminium	kartáčovaná oceľ, kartáčovaná oceľ, szálcsiszolt acél, oţel periat	bílám biela, fehér, alb	plast, plast, műanyag, plastic
	PA-ZASVELLO-CN-05	PA-ZASVELLO-CN-06	PA-ZASVELLO-CN-10	
	PA-ZASVELLO-CP-05	PA-ZASVELLO-CP-06	PA-ZASVELO-CP-10	

	černá matná, čierna matná, fekete matt, negru mat	zlato, zlato, arany, aur	plast, plast, műanyag, plastic
	PA-ZASVELLO-CN-20M	PA-ZASVELLO-CN-21	
	PA-ZASVELO-CP-20M	PA-ZASVELLO-CP-21	





Možnost použítí LED osvětlení. Doporučený kryt PA-OSMLGLAXMIC3M-00N  
 Možnosť použitia LED osvetlenia. Odporúčaný kryt PA-OSMLGLAXMIC3M-00N  
 LED világítás használatának lehetőségére. Ajánlott PA-OSMLGLAXMIC3M-00N borítók  
 Posibilitatea utilizării iluminatului cu LED-uri. Capac recomandat PA-OSMLGLAXMIC3M-00N



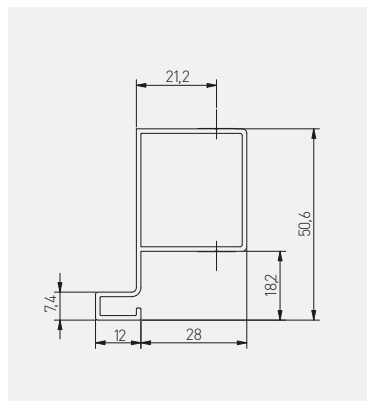



Bezúchytkový systém VELLO  
 Bezúchytkový systém VELLO  
 VELLO rejtett fogantyú profil  
 Sistem fără mâner VELLO

NEW



	 C mm	 L mm			
<b>pro řezání na rezanie vágáshoz pentru tăiere</b>	3000	PA-VELLO-TJ3M-05	kartáčovaná ocel, kartáčovaná ocel, szálciszott acél, oțel periat	bílám biela, fehér, alb	hliník, hliník, aluminium, aluminium, aluminium

	 C mm	 L mm			
<b>pro řezání na rezanie vágáshoz pentru tăiere</b>	3000	PA-VELLO-TJ3M-20M	zlato, zlato, arany, aur	černá matná, čierna matná, fekete matt, negru mat	hliník, hliník, aluminium, aluminium

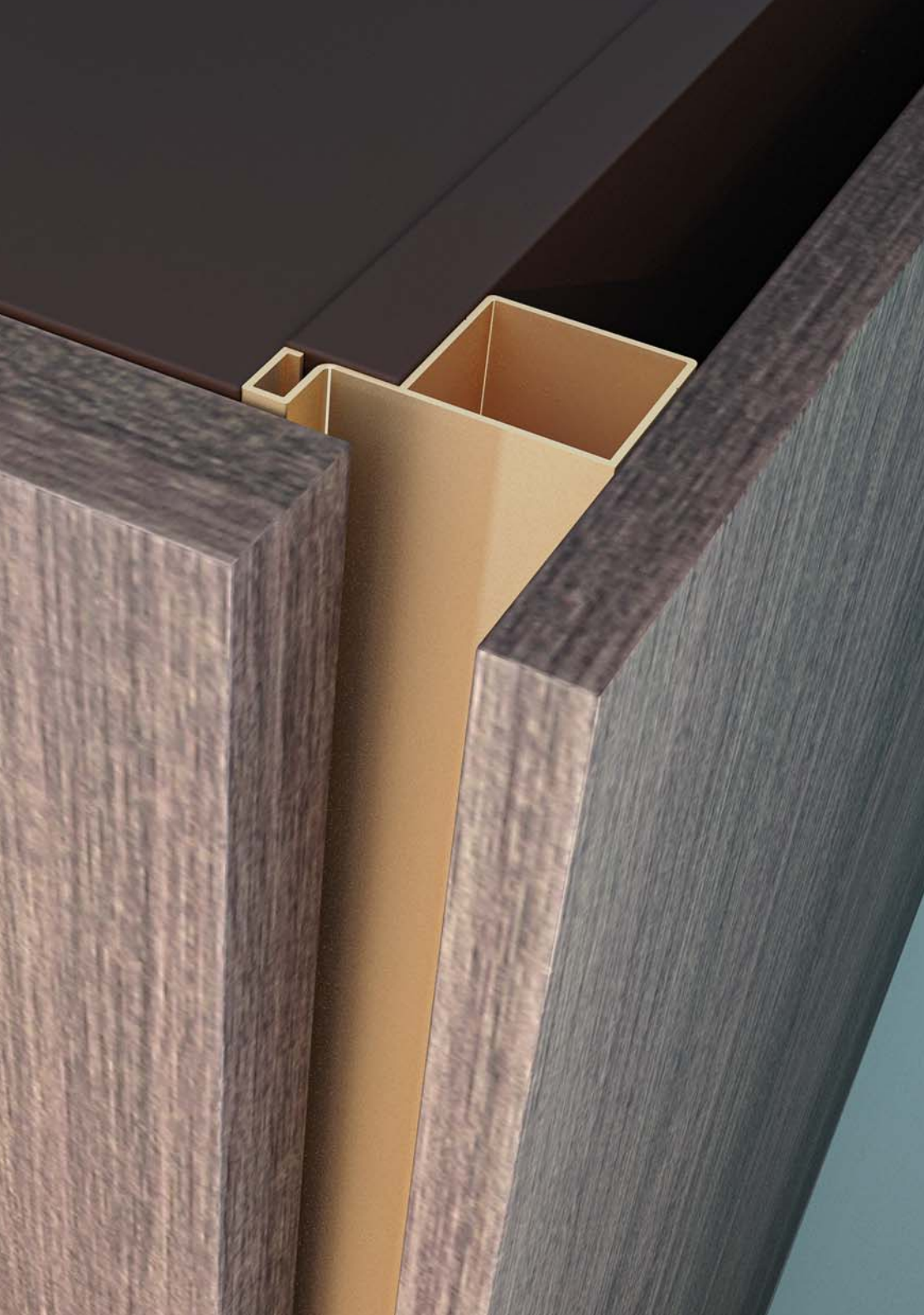



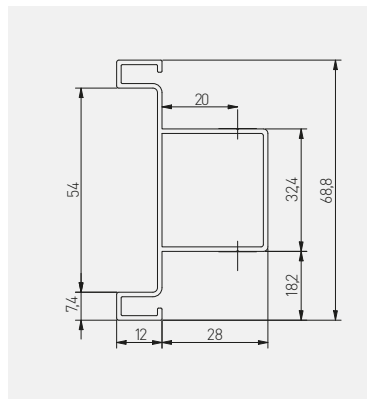

Bezúchytkový systém VELLO  
 Bezúchytkový systém VELLO  
 VELLO rejtett fogantyú profil  
 Sistem fără mâner VELLO

NEW





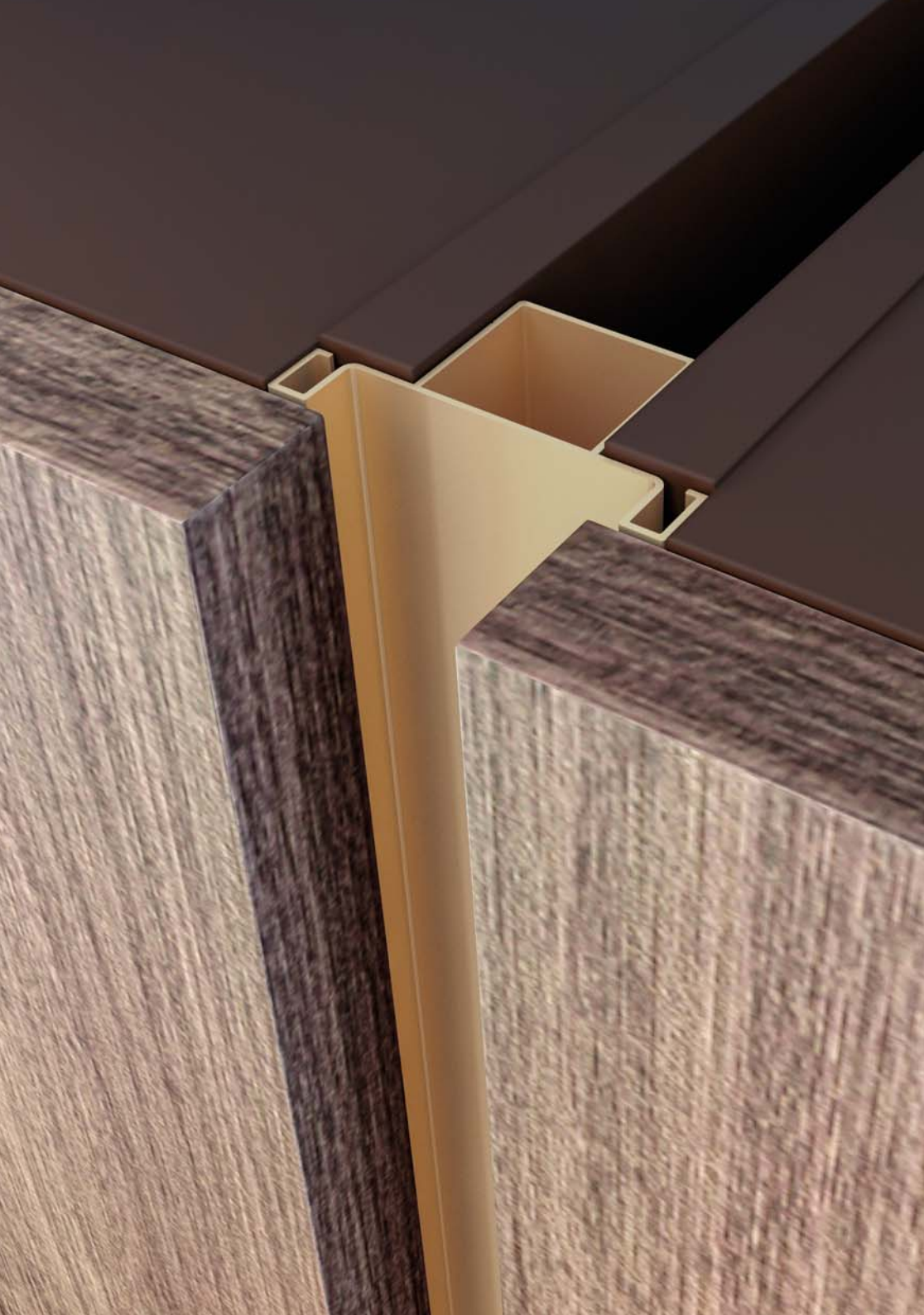

 C mm	 L mm				
		hliník, hliník, aluminíum, aluminíu	kartáčovaná oceľ, kartáčovaná oceľ, szálcsiszolt acél, oţel periat	bílám biela, fehér, alb	
pro řezání na rezanie vágáshoz pentru tăiere	3000	PA-VELLO-TD3M-05	PA-VELLO-TD3M-06	PA-VELLO-TD3M-10	hliník, hliník, aluminíum, aluminíu

 C mm	 L mm			
		černá matná, čierna matná, fekete matt, negru mat	zlato, zlato, arany, aur	
pro řezání na rezanie vágáshoz pentru tăiere	3000	PA-VELLO-TD3M-20M	PA-VELLO-TD3M-21	hliník, hliník, aluminíum, aluminíu

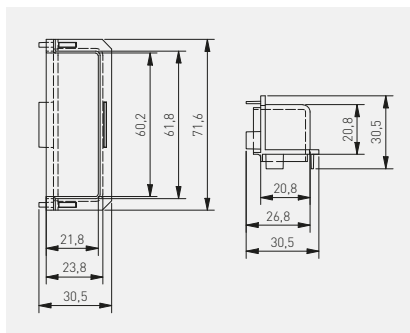





Bezúchytkový systém VELLO  
 Bezúchytkový systém VELLO  
 VELLO rejttett fogantyú profil  
 Sistem fără mâner VELLO

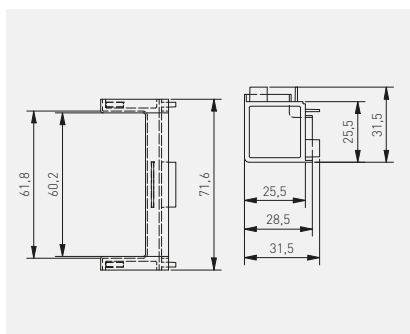

			
hlínik, hlínik, aluminíum, aluminíu	inox inox inox inox	bílám biela, fehér, alb	plast, plast, műanyag, plastic
PA-LACZVELLO-CIN-05	PA-LACZVELLO-CIN-06	PA-LACZVELLO-CIN-10M	
			
černá matná, čierná matná, fekete matt, negru mat	zlato, zlato, arany, aur	plast, plast, műanyag, plastic	
PA-LACZVELLO-CIN-20M	PA-LACZVELLO-CIN-21		

Bezúchytkový systém VELLO  
 Bezúchytkový systém VELLO  
 VELLO rejttett fogantyú profil  
 Sistem fără mâner VELLO





			
hlínik, hlínik, aluminíum, aluminíu	inox inox inox inox	bílám biela, fehér, alb	plast, plast, műanyag, plastic
PA-LACZVELLO-COUT-05	PA-LACZVELLO-COUT-06	PA-LACZVELLO-COUT-10M	
			
černá matná, čierná matná, fekete matt, negru mat	zlato, zlato, arany, aur	plast, plast, műanyag, plastic	
PA-LACZVELLO-COUT-20M	PA-LACZVELLO-COUT-21		



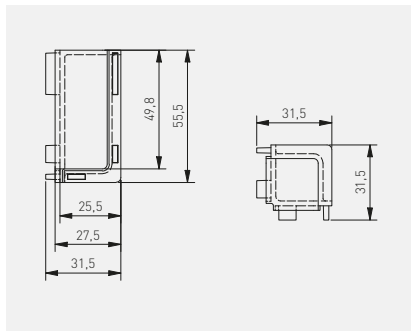



Bezúchytkový systém VELLO  
 Bezúchytkový systém VELLO  
 VELLO rejtekt fogantyú profil  
 Sistem fără mâner VELLO

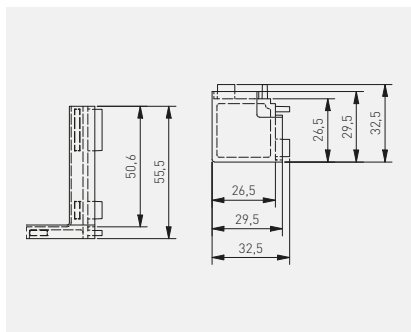

			
hliník, hliník, aluminíum, aluminíu	inox inox inox inox	bílám biela, fehér, alb	plast, plast, műanyag, plastic
PA-LACZVELLO-LIN-05	PA-LACZVELLO-LIN-06	PA-LACZVELLO-LIN-10M	
			
černá matná, čierna matná, fekete matt, negru mat	zlato, zlato, arany, aur	plast, plast, műanyag, plastic	
PA-LACZVELLO-LIN-20M	PA-LACZVELLO-LIN-21		

Bezúchytkový systém VELLO  
 Bezúchytkový systém VELLO  
 VELLO rejtekt fogantyú profil  
 Sistem fără mâner VELLO



			
hliník, hliník, aluminíum, aluminíu	inox inox inox inox	bílám biela, fehér, alb	plast, plast, műanyag, plastic
PA-LACZVELLO-LOUT-05	PA-LACZVELLO-LOUT-06	PA-LACZVELLO-LOUT-10M	
			
černá matná, čierna matná, fekete matt, negru mat	zlato, zlato, arany, aur	plast, plast, műanyag, plastic	
PA-LACZVELLO-LOUT-20M	PA-LACZVELLO-LOUT-21		

Knopka J4  
Knopka J4  
Gomb fogantyú J4  
Buton J4

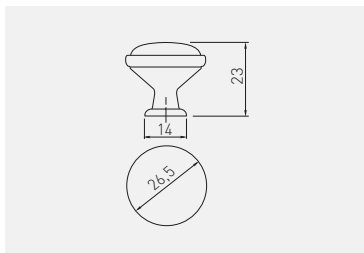

vzorovaný vzorovaný motivum model	starožitná mosaz starožitná mosadz antik bronz alama antică	starožitné striebro starožitné striebro antik ezüst argint antic	ZnAl + porcelán ZnAl + porcelán ZnAl + porcelán ZnAl + porțelan
autumn rose	GP-0728-J4-B	-	
spring flower	GP-0728-J4-R	-	
blue rose	GP-0728-J4-A-04	GP-0728-J4-A-07	
orient gold	GP-0728-J4-C-04	-	



autumn rose



spring flower



blue rose



orient gold

Úchytka 728B  
Úchytka 728B  
Fogantyú 728B  
Mâner 728B

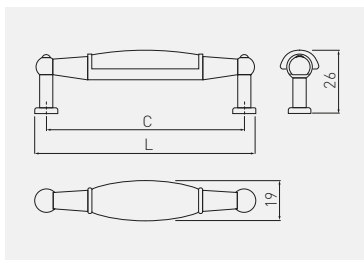

vzorovaný vzorovaný motivum model	C mm	L mm	starožitná mosaz starožitná mosadz antik bronz alama antică	ZnAl + porcelán ZnAl + porcelán ZnAl + porcelán ZnAl + porțelan
spring flower	96	106	UP-WP0728-BR	
country	96	106	UP-WP0728-BK	
ornament	96	106	UP-WP0728-BX	
autumn rose	96	106	UP-WP0728-BB	



spring flower



country



ornament



autumn rose

Úchytka 728P  
 Úchytka 728P  
 Fogantyú 728P  
 Mâner 728P

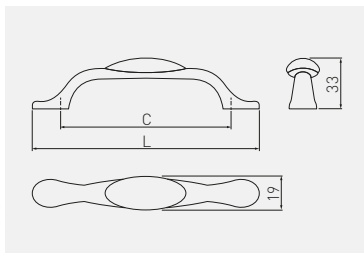

	 C mm	 L mm			
 vzorovaný vzorovaný motivum model			starožitná mosaz starožitná mosadz antik bronz alama antică	starožitné striebro starožitné striebro antik ezüst argint antic	ZnAl + porcelán ZnAl + porcelán ZnAl + porcelán ZnAl + porțelan
blue rose	96	125	UP-WP0728-PA-04	UP-WP0728-PA-07	
orient gold	96	125	UP-WP0728-PC-04	-	
ornament	96	125	UP-WP0728-PX	-	
autumn rose	96	125	UP-WP0728-PB	-	
spring flower	96	125	UP-WP0728-PR	-	
country	96	125	UP-WP0728-PK	-	
milky	96	125	UP-WP0728-P0	-	



blue rose



orient gold



ornament



autumn rose



spring flower



country



milky

Úchytka ALATRI  
 Úchytka ALATRI  
 Fogantyú ALATRI  
 Mâner ALATRI

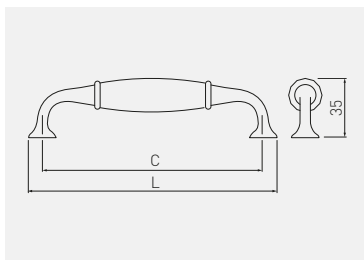

	 C mm	 L mm		
			starožitná mosaz starožitná mosadz antik bronz alama antică	ZnAl + porcelán ZnAl + porcelán ZnAl + porcelán ZnAl + porțelan
128	144		UZ-ALATR-128-04	

Úchytka RETRIS  
 Úchytka RETRIS  
 Fogantyú RETRIS  
 Mâner RETRIS

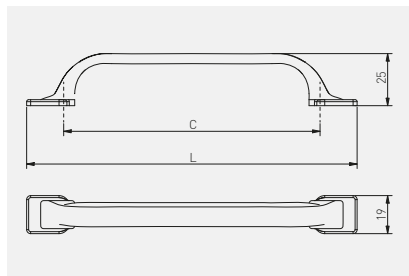

 C mm	 L mm				
		starožitná mosaz starožitná mosadz antik bronz alama antică	starožitné stříbro starožitné striebro antik ezüst argint antic	černá matná, čierna matná, fekete matt, negru mat	ZnAl
128	165	UZ-RETRIS-128-04	UZ-RETRIS-128-07	UZ-RETRIS-128-20M	

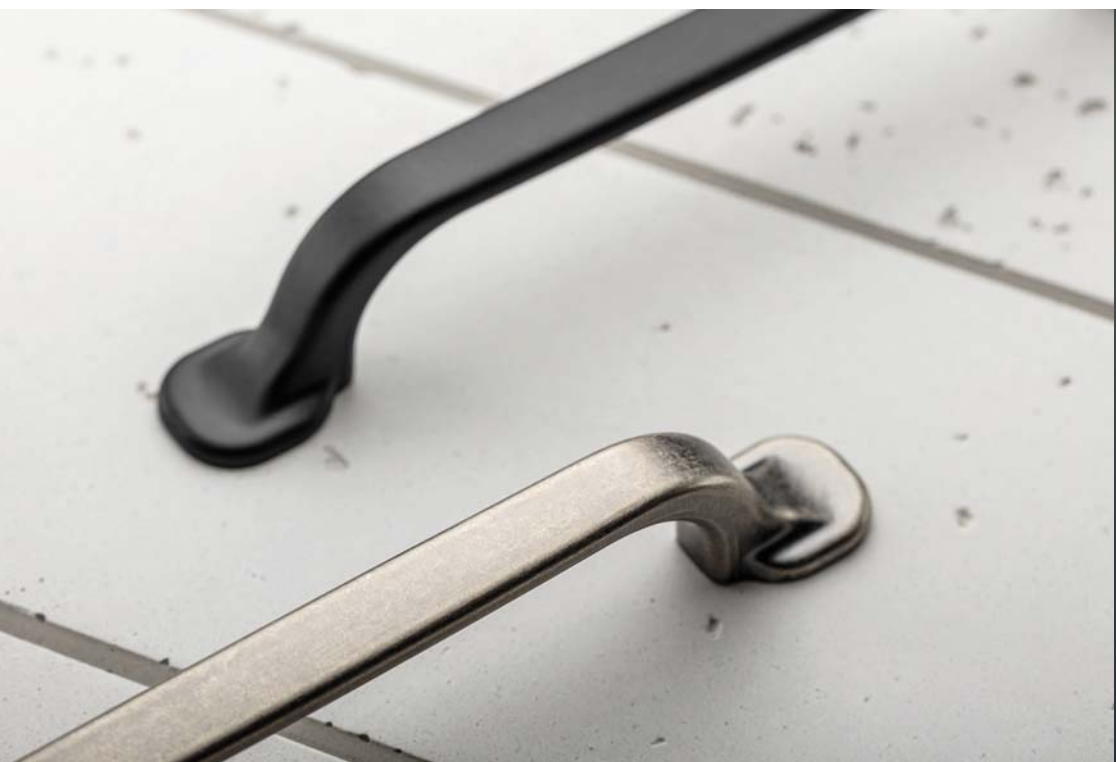

Úchytka MARSALA  
 Úchytka MARSALA  
 Fogantyú MARSALA  
 Mâner MARSALA

NEW

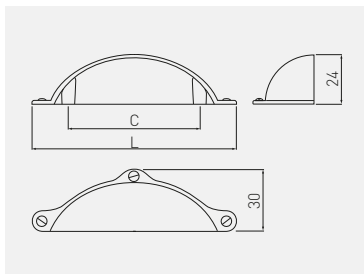

C mm	L mm					
		starožitné striebro starožitné striebro antik ezüst argint antic	starožitná kartáčovaná mosaz, starožitná kartáčovaná mosadz, antik szálciszolt sárgaréz, alamâ periatâ anticâ	bílá matná, biela matná, fehér matt, alb mat		ZnAl
64	99,5	UZ-MARSA-64-07	UZ-MARSA-64-09	UZ-MARSA-64-10M		
C mm	L mm					
		kartáčovaný titan kartáčovaný titán csiszolt titán titan periat	měď méd rész cupru	kartáčované zlato, kartáčované zlato, szálciszolt arany, aur periat	černá matná, čierna matná, fekete matt, negru mat	ZnAl
64	99,5	UZ-MARSA-64-11	UZ-MARSA-64-15	UZ-MARSA-64-18	UZ-MARSA-64-20M	



Úchytka UZ-12  
 Úchytka UZ-12  
 Fogantyú UZ-12  
 Mâner UZ-12

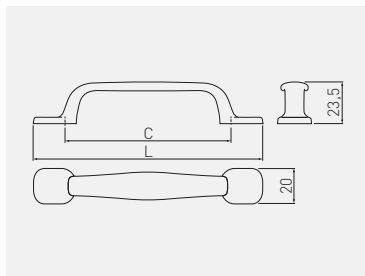

C mm	L mm				
96	131	starožitná mosaz starožitná mosadz antik bronz alama anticã	starožitné striebro starožitné striebro antik ezüst argint antic	ãernã matnã, ãierna matnã, fekete matt, negru mat	ZnAl
		UZ-12-096-04N	UZ-12-096-07	UZ-12-096-20M	



Knopka CENTO  
 Knopka CENTO  
 Gomb fogantyú CENTO  
 Buton CENTO

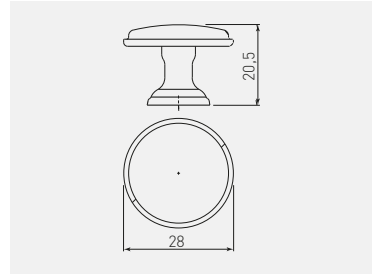

	starožitná mosaz starožitná mosadz antik bronz alama antică	starožitné striebro starožitné striebro antik ezüst argint antic	starožitná meď, starožitná meď, antik réz, cupru antic	černá matná, čierna matná, fekete matt, negru mat	ZnAl
<b>Knopka Knopka Gomb fogantyú Buton</b>	GZ-CENTO-1-04	GZ-CENTO-1-07	GZ-CENTO-1-14	GZ-CENTO-1-20M	



Knopka IMPERIA  
Knopka IMPERIA  
Gomb fogantyú IMPERIA  
Buton IMPERIA

RETRO

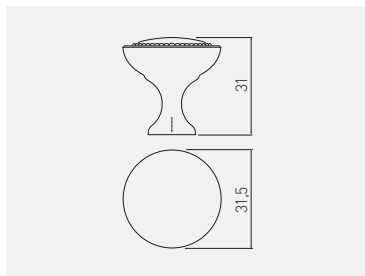

	satén satén satén	kartáčovány títan kartáčovány títan csiszolt títan titan periat	černá matná, čierna matná, fekete matt, negru mat	hliník, hliník, aluminium, aluminiumu
<b>Knopka Knopka Gomb fogantyú Buton</b>	GA-IMPER-1-02B	GA-IMPER-1-11	GA-IMPER-1-20M	

Úchytka VASTO  
Úchytka VASTO  
Fogantyú VASTO  
Mâner VASTO

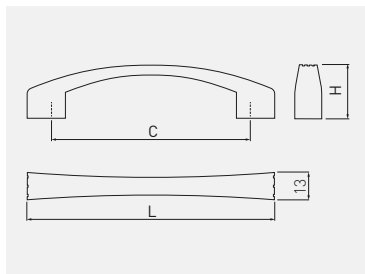

 C mm	 L mm	 H mm		
			starožitná kartáčovaná mosaz, starožitná kartáčovaná mosadz, antik szálcsiszolt sárgaréz, alamâ periatâ anticâ	ZnAl
96	120	26	UZ-VASTO-96-09	
128	151	27	UZ-VASTO-128-09	



Knopka SONET  
 Knopka SONET  
 Gomb fogantyú SONET  
 Buton SONET

NEW

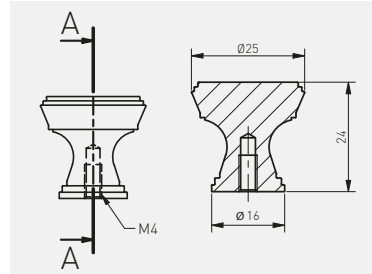

	starožitné striebro starožitné striebro antik ezüst argint antic	kartáčované zlato, kartáčované zlato, szálcsiszolt arany, aur periat	černá matná, čierna matná, fekete matt, negru mat	ZnAl
<b>Knopka Knopka Gomb fogantyú Buton</b>	GZ-SONET-1-07	GZ-SONET-1-18	GZ-SONET-1-20M	

RETRO



Úchytka PALERMO  
 Úchytka PALERMO  
 Fogantyú PALERMO  
 Mâner PALERMO

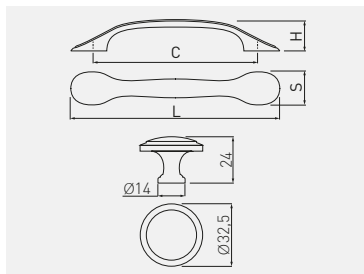

C mm	L mm	H mm	S mm		
96	127	22,5	23	starožitné striebro starožitné striebro antik ezüst argint antic	ZnAl
128	159	23	25	UZ-PALER-96-07	
Knopka Knopka Gomb fogantyú Buton	-	-	-	UZ-PALER-128-07	
				GZ-PALER-1-07	



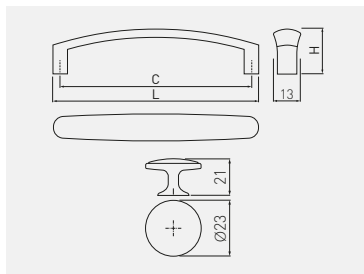

Úchytka OLBIA  
 Úchytka OLBIA  
 Fogantyú OLBIA  
 Mâner OLBIA

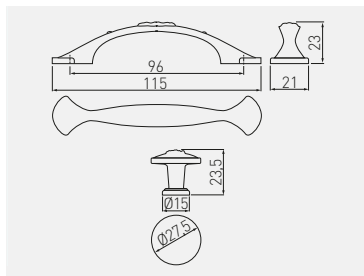

C mm	L mm	H mm		
96	103	22	starožitná mosaz starožitná mosadz antik bronz alama antică	ZnAl
128	136	24	UZ-OLBIA-96-04	
Knopka Knopka Gomb fogantyú Buton	-	-	UZ-OLBIA-128-04	
			GZ-OLBIA-1-04	







Knopka ARDEA  
Knopka ARDEA  
Gomb fogantyú ARDEA  
Buton ARDEA

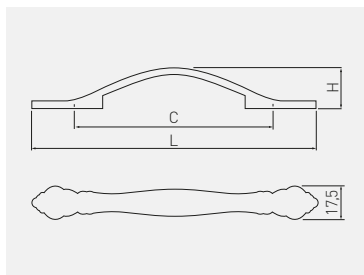

 C mm	 L mm		
		starožitná mosaz starožitná mosadz antik bronz alama antică	
96	115	UZ-ARDEA-96-09	ZnAl
Knopka Knopka Gomb fogantyú Buton	-	GZ-ARDEA-1-09	





Úchytka WERONA  
Úchytka WERONA  
Fogantyú WERONA  
Mâner WERONA

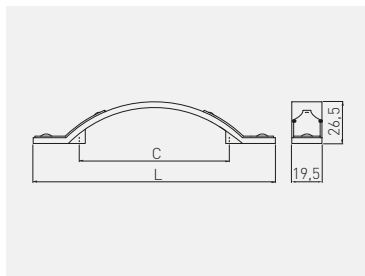

 C mm	 L mm	 H mm			
			starožitná mosaz starožitná mosadz antik bronz alama antică	starožitná kartáčovaná mosaz, starožitná kartáčovaná mosadz, antik szálcsiszolt sárgaréz, alamă periată antică	černá, chrom čierna, chróm fekete, króm negru, crom
96	148	24,5	UZ-WERON-96-04	UZ-WERON-96-09	UZ-WERON-96-12
128	183	26,5	UZ-WERON-128-04	UZ-WERON-128-09	UZ-WERON-128-12

Úchytka ARCHE\*  
 Úchytka ARCHE\*  
 Fogantyú ARCHE\*  
 Mâner ARCHE\*





 C mm	 L mm		
96	155	starožitná kartáčovaná mosaz, starožitná kartáčovaná mosadz, antik szálciszolt sárgaréz, alamă periată antică	ZnAl
UZ-ARCH096-AEB			

\*K dispozici pro speciální objednávky / K dispozicii na speciálne objednávky / Külön megrendelésben kapható / Disponibil pentru comenzi speciale

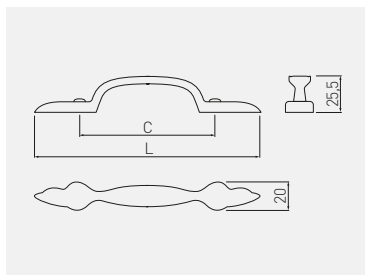
Úchytka AREZO  
 Úchytka AREZO  
 Fogantyú AREZO  
 Mâner AREZO



 C mm	 L mm		
96	160	starožitná mosaz starožitná mosadz antik bronz alamă antică	ZnAl
UZ-AREZO-96-04			

Úchytka ABIATE  
 Úchytka ABIATE  
 Fogantyú ABIATE  
 Mâner ABIATE

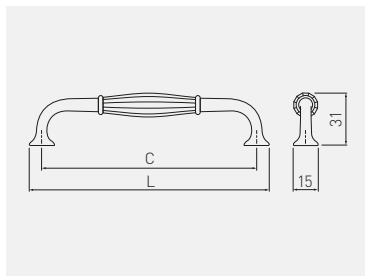

 C mm	 L mm		
128	143	starožitná mosaz starožitná mosadz antik bronz alama antică	ZnAl
UZ-ABIAT-128-04			



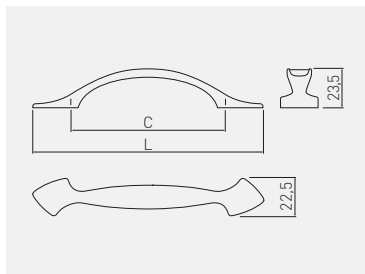

Úchytka ADRIN  
 Úchytka ADRIN  
 Fogantyú ADRIN  
 Mâner ADRIN

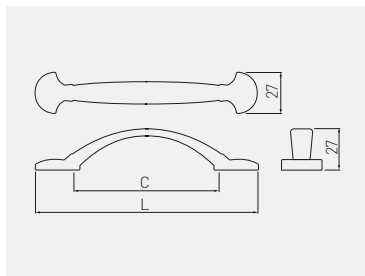

 C mm	 L mm		
96	139	starožitná mosaz starožitná mosadz antik bronz alama antică	ZnAl
UZ-ADRIN-96-04			

Úchytka ACERA  
 Úchytka ACERA  
 Fogantyú ACERA  
 Mâner ACERA



 C mm	 L mm		
		starožitná mosaz starožitná mosadz antik bronz alama antică	ZnAl
96	147	UZ-ACERA-96-04	

Úchytka RENNES  
 Úchytka RENNES  
 Fogantyú RENNES  
 Mâner RENNES

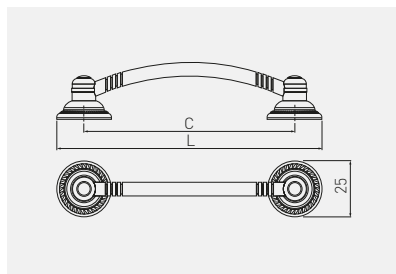

 C mm	 L mm		
		starožitná mosaz starožitná mosadz antik bronz alama antică	ZnAl
96	121	UZ-REN096-04A	

Úchytka ROYAL  
 Úchytka ROYAL  
 Fogantyú ROYAL  
 Mâner ROYAL

GZ-ROYAL3-1-10-03



UZ-ROYAL4-96-03



UZ-ROYAL1-96-10-03



UZ-ROYAL2-96-10-03



UZ-ROYAL3-96-10-03



UZ-ROYAL5-128-10-03

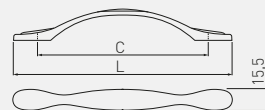
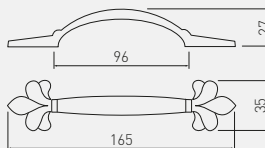
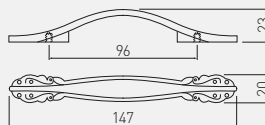
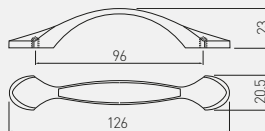
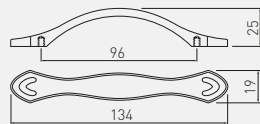
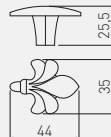

	C mm	L mm		
vzorovaný vzorovaný motivum model			bílá, zlato biela, zlato fehér, arany alb, aur	
latina	96	126	UZ-ROYAL1-96-10-03	ZnAl
werona	96	147	UZ-ROYAL2-96-10-03	
genova	96	165	UZ-ROYAL3-96-10-03	
reggio	96	134	UZ-ROYAL4-96-03	
piano	96	131	UZ-ROYAL5-96-10-03	
	128	164	UZ-ROYAL5-128-10-03	
genova	Knopka Knopka Gomb fogantyú Buton	35	GZ-ROYAL3-1-10-03	

Knopka UZ-WP146  
 Knopka UZ-WP146  
 UZ-WP146 gomb fogantyú  
 Buton UZ-WP146

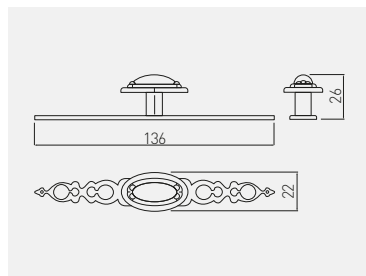

	starožitná mosaz starožitná mosadz antik bronz alama antică	ZnAl
Knopka Knopka Gomb fogantyú Buton	UZ-WP146-04	

Knopka GZ-1136  
 Knopka GZ-1136  
 GZ-1136 gomb fogantyú  
 Buton GZ-1136

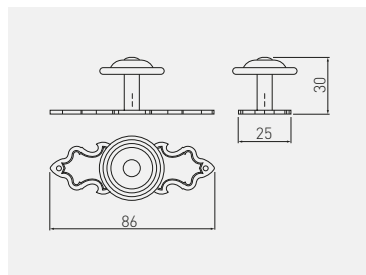

	starožitná mosaz starožitná mosadz antik bronz alama antică	ZnAl
Knopka Knopka Gomb fogantyú Buton	GZ-WP1136-04	



Knopka GZ-1148  
 Knopka GZ-1148  
 GZ-1148 gomb fogantyú  
 Buton GZ-1148

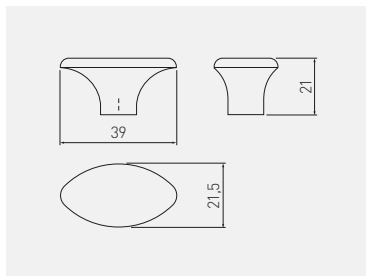

	starožitná mosaz starožitná mosadz antik bronz alama antică	ZnAl
<b>Knopka</b> <b>Knopka</b> <b>Gomb fogantyú</b> <b>Buton</b>	GZ-WP1148-04	

Knopka GZ-1152\*  
 Knopka GZ-1152\*  
 GZ-1152\* gomb fogantyú  
 Buton GZ-1152\*

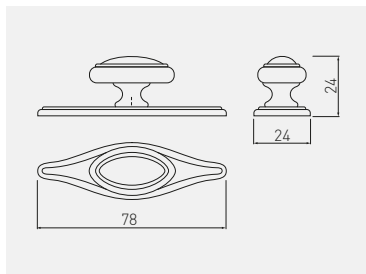

	starožitná mosaz starožitná mosadz antik bronz alama antică	ZnAl
<b>Knopka</b> <b>Knopka</b> <b>Gomb fogantyú</b> <b>Buton</b>	GZ-WP1152-04	

\*K dispozici pro speciální objednávky / K dispozicii na speciálne objednávky / Kűtön megrendelésben kapható / Disponibil pentru comenzi speciale



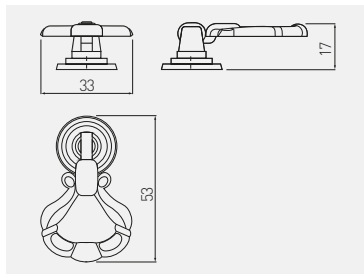

Klepadlo WP-1147  
 Klopadlo WP-1147  
 Kópogtató fogantyú KT-1147  
 Knocker KT-1147

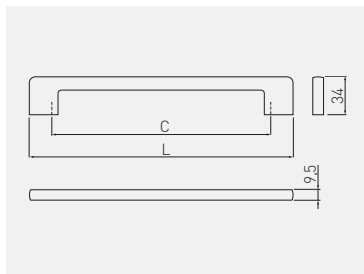

		
	starožitná mosaz starožitná mosadz antik bronz alama antică	ZnAl
<b>Klepadlo Klopadlo Kópogtató Knocker</b>	KT-WP1147-04	

Úchytka UZ-CRA14\*  
 Úchytka UZ-CRA14\*  
 Fogantyú UZ-CRA14\*  
 Mâner UZ-CRA14\*







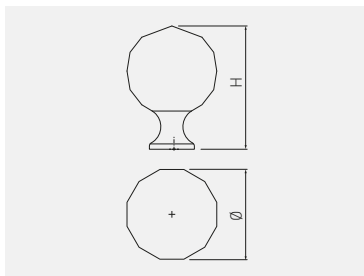

			
mm	mm		
		chrom, chróm, króm, crom	ZnAl
<b>128</b>	<b>166</b>	UZ-CRA14-128	
<b>192</b>	<b>230</b>	UZ-CRA14-192	
<b>320</b>	<b>358</b>	UZ-CRA14-320	

\*K dispozíci pro speciální objednávky / K dispozícii na špeciálne objednávky / Külön megrendelésben kapható / Disponibil pentru comenzi speciale







Knopka GZ-CRPA  
Knopka GZ-CRPA  
Gomb fogantyú GZ-CRPA  
Buton GZ-CRPA

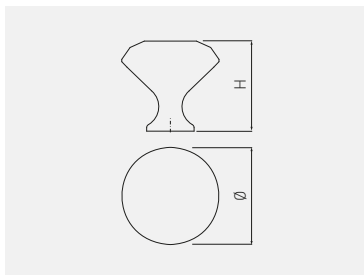

 mm	 mm				
		chrom, bílý krystal chróm, biely krýštál króm, fehér kristály crom, cristal alb	chrom, černá krystal chróm, čierna krýštál króm, fekete kristály crom, cristal negru		mosaz, bílý krystal mosadz, biely krýštál sárgaréz, fehér kristály alamâ cristal alb
20	33	GZ-CRPA20-01	-	-	ZnAl + sklo ZnAl + sklo ZnAl + üveg ZnAl + sticla
25	37	GZ-CRPA25-01	-	-	
30	44	GZ-CRPA30-01	GZ-CRPA30-A1	GZ-CRPA30-03	
40	55	GZ-CRPA40-01	-	-	



Knopka GZ-CRPB  
Knopka GZ-CRPB  
Gomb fogantyú GZ-CRPB  
Buton GZ-CRPB



 mm	 mm				
		chrom, bílý krystal chróm, biely krýštál króm, fehér kristály crom, cristal alb	chrom, černá krystal chróm, čierna krýštál króm, fekete kristály crom, cristal negru		mosaz, bílý krystal mosadz, biely krýštál sárgaréz, fehér kristály alamâ cristal alb
20	26	GZ-CRPB20-01	-	-	ZnAl + sklo ZnAl + sklo ZnAl + üveg ZnAl + sticla
25	28	GZ-CRPB25-01	GZ-CRPB25-A1	-	
30	30	GZ-CRPB30-01	GZ-CRPB30-A1	GZ-CRPB30-03	
40	38	GZ-CRPB40-01	GZ-CRPB40-A1	-	

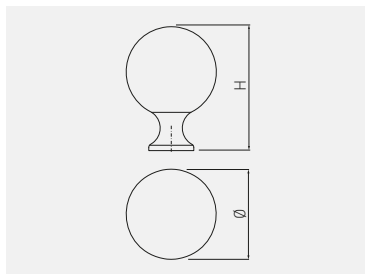

Knopka GZ-CRPC  
 Knopka GZ-CRPC  
 Gomb fogantyú GZ-CRPC  
 Buton GZ-CRPC

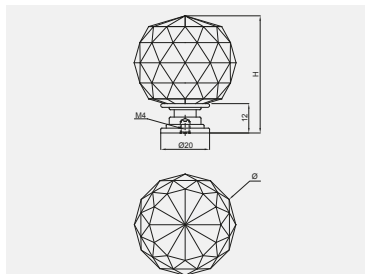

 mm	 mm		
30	43	chrom, biely krystal chróm, biely kryštál króm, fehér kristály crom, cristal alb	ZnAl + sklo ZnAl + sklo ZnAl + üveg ZnAl + sticliä
GZ-CRPC30-01			

Knopka GZ-CRPJ  
 Knopka GZ-CRPJ  
 Gomb fogantyú GZ-CRPJ  
 Buton GZ-CRPJ



 mm	 mm		
30	43	chrom, biely krystal chróm, biely kryštál króm, fehér kristály crom, cristal alb	ZnAl + sklo ZnAl + sklo ZnAl + üveg ZnAl + sticliä
40	49	ID-GZ-CRPJ40-01	



Úchytka KID  
 Úchytka KID  
 Fogantyú KID  
 Mâner KID

BLOCK



CLOUD



STAR



BUTTON



FLAMING



HEART



CROWN



TWITT

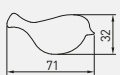
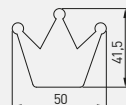
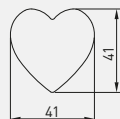
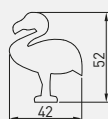
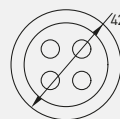
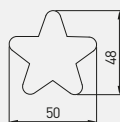
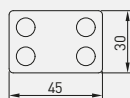

	zelená zelená zöld verde	modrá modrá kék albastru	červená červená piros roşu	šedá, sivá, szürke, gri	žlutá žltá sárga galben	růžová ruřová růzsaszín roz	
<b>block</b>	UM-BLOCK-ZL	UM-BLOCK-NB	UM-BLOCK-CZ	-	-	-	prýř + ZnAl guma + ZnAl radír + ZnAl cauciuc + ZnAl
<b>cloud</b>	-	UM-CLOUD-NB	-	UM-CLOUD-SZ	-	-	
<b>star</b>	-	UM-STAR-NB	-	-	UM-STAR-ZT	UM-STAR-RZ	
<b>button</b>	-	UM-BUTTON-NB	-	UM-BUTTON-SZ	-	-	
<b>flaming</b>	-	-	-	UM-FLAMING-SZ	-	UM-FLAMING-RZ	
<b>heart</b>	-	-	-	-	-	UM-HEART-RZ	
<b>crown</b>	-	-	-	-	-	UM-CROWN-RZ	
<b>twitt</b>	UM-TWITT-ZL	-	-	UM-TWITT-SZ	-	-	



Úchytka KID WILD  
 Úchytka KID WILD  
 Fogantyú KID WILD  
 Mâner KID WILD

CHILDREN



UM-KID-P-001



UM-KID-Q-001



UM-KID-U-001

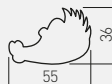

slon / slon / elefánt / elefant	UM-KID-P-001	prýž + ZnAl guma + ZnAl radír + ZnAl cauciuc + ZnAl
krokodýl / krokodil / krokodil / crocodil	UM-KID-Q-001	
panda / panda / panda / urs panda	UM-KID-U-001	

Úchytka KID PLAY  
 Úchytka KID PLAY  
 Fogantyú KID PLAY  
 Mâner KID PLAY



UM-KID-C-001



UM-KID-D-001



UM-KID-E-001



květ / kvet / virág / floare	UM-KID-C-001	prýž + ZnAl guma + ZnAl radír + ZnAl cauciuc + ZnAl
auto / auto / autó / mašinā	UM-KID-D-001	
mič / lopta / labda / minge	UM-KID-E-001	



Úchytka KID FARM  
 Úchytka KID FARM  
 Fogantyú KID FARM  
 Mâner KID FARM



UM-KID-W-001



UM-KID-X-001



UM-KID-Z-001



UM-UNICORN-RZ



kůň / kôň / ló / cal	UM-KID-W-001	pryž + ZnAl guma + ZnAl radír + ZnAl cauciuc + ZnAl
králík / králik / nyúl / iepure	UM-KID-X-001	
pes / pes / kutya / câine	UM-KID-Z-001	
jednorozec / jednorozec / egyszarvú / inorog	UM-UNICORN-RZ	



Věšák TOLEDO A0  
Vešiák TOLEDO A0  
Fogas TOLEDO A0  
Agatator TOLEDO A0

MODERN

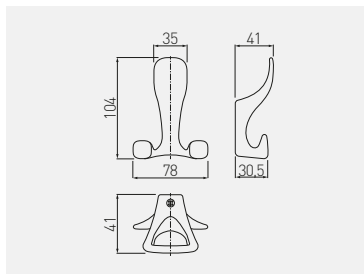

WZ-TOLED-A0-01	chrom / chróm / króm / crom	ZnAl
WZ-TOLED-A0-02	satén / satén / szatén / satin	
WZ-TOLED-A0-05	hliník / hliník / alumínium / aluminiu	
WZ-TOLED-A0-06	kartáčovaná ocel / kartáčovaná ocel / szálcsiszolt acél / oțel periat	
WZ-TOLED-A0-20M	černá matná / čierna matná / fekete matt / negru mat	

Věšák TOLEDO B0  
Vešiák TOLEDO B0  
Fogas TOLEDO B0  
Agatator TOLEDO B0

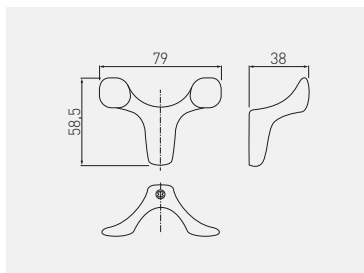

WZ-TOLED-B0-01	chrom / chróm / króm / crom	ZnAl
WZ-TOLED-B0-02	satén / satén / szatén / satin	
WZ-TOLED-B0-05	hliník / hliník / alumínium / aluminiu	
WZ-TOLED-B0-06	kartáčovaná ocel / kartáčovaná ocel / szálcsiszolt acél / oțel periat	
WZ-TOLED-B0-20M	černá matná / čierna matná / fekete matt / negru mat	

Věšák TOLEDO C0  
 Vešiák TOLEDO C0  
 Fogas TOLEDO C0  
 Agatator TOLEDO C0

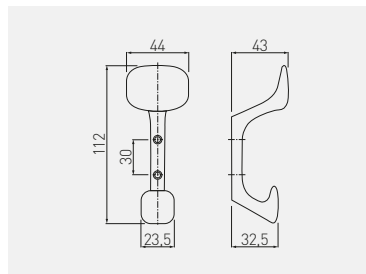

WZ-TOLED-C0-01	chrom / chróm / króm / crom	ZnAl
WZ-TOLED-C0-02	satén / satén / szatén / satin	
WZ-TOLED-C0-05	hliník / hliník / alumínium / aluminiu	
WZ-TOLED-C0-06	kartáčovaná ocel / kartáčovaná ocel / szálcsiszolt acél / oţel periat	
WZ-TOLED-C0-20M	černá matná / čierna matná / fekete matt / negru mat	

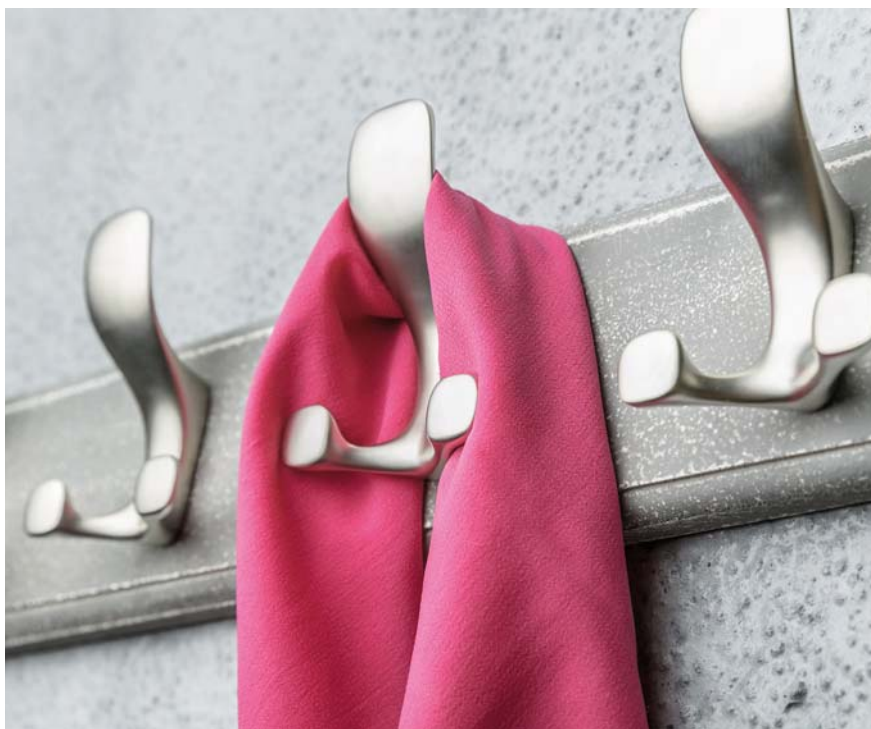

Věšák WALENCIA  
Vešiak WALENCIA  
Fogas WALENCIA  
Agatator WALENCIA

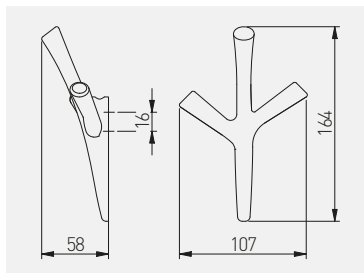

WZ-WALENCIA-01	chrom / chróm / króm / crom	ZnAl
WZ-WALENCIA-06	kartáčovaná ocel / kartáčovaná ocel / szálcsiszolt acél / oțel periat	
WZ-WALENCIA-20M	černá matná / čierna matná / fekete matt / negru mat	

Věšák CORDOBA  
Vešiak CORDOBA  
Fogas CORDOBA  
Agatator CORDOBA

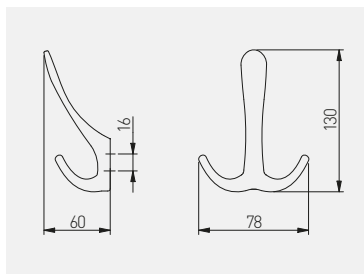

WZ-CORDOBA-01	chrom / chróm / króm / crom	ZnAl
WZ-CORDOBA-06	kartáčovaná ocel / kartáčovaná ocel / szálcsiszolt acél / oțel periat	
WZ-CORDOBA-20M	černá matná / čierna matná / fekete matt / negru mat	

Věšák K2201  
Vešiak K2201  
Fogas K2201  
Agatator K2201

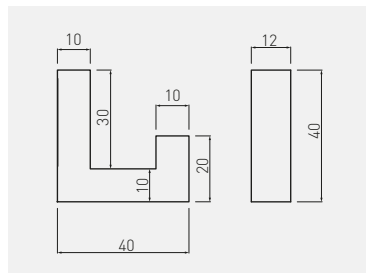

WZ-K2201-01	chrom / chróm / króm / crom	ZnAl
WZ-K2201-06	kartáčovaná ocel / kartáčovaná ocel / szálcsiszolt acél / oțel periat	
WZ-K2201-CZ	černá / čierna / fekete / negru	

Věšák K2202  
Vešiak K2202  
Fogas K2202  
Agatator K2202

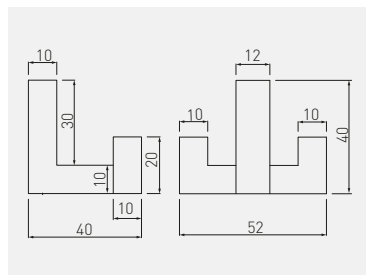

WZ-K2202-01	chrom / chróm / króm / crom	ZnAl
WZ-K2202-06	kartáčovaná ocel / kartáčovaná ocel / szálcsiszolt acél / oțel periat	
WZ-K2202-CZ	černá / čierna / fekete / negru	

Věšák CAPITAL  
Vešiak CAPITAL  
Fogas CAPITAL  
Aगतator CAPITAL

SHAPE ART

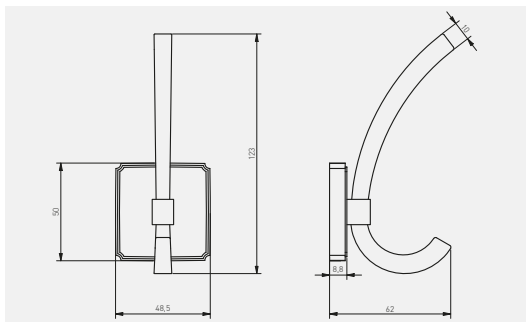

WZ-CAPITAL-18	kartáčované zlato / kartáčované zlato / szálcsiszolt arany / aur periat	ZnAl
WZ-CAPITAL-20M	černá matná / čierna matná / fekete matt / negru mat	

Věšák 804  
Vešiak 804  
Fogas 804  
Aगतator 804

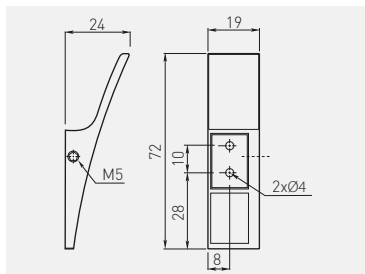

WZ-804-20-01	chrom / chróm / króm / crom	ZnAl
WZ-804-20-05	hliník / hliník / aluminium / aluminiu	
WZ-804-20-06	kartáčovaná ocel / kartáčovaná ocel / szálcsiszolt acél / oţel periat	



Věšák K23-A0  
 Vešiak K23-A0  
 Fogas K23-A0  
 Agatator K23-A0

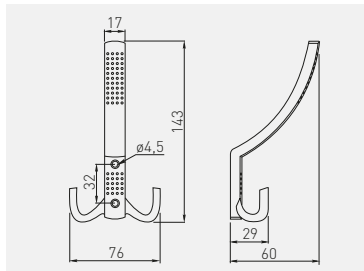

WZ-A0-K23-01	chrom / chróm / króm / crom	ZnAl
WZ-A0-K23-02	satén / satén / szatén / satin	
WZ-A0-K23-03	mosaz / mosadz / sárgaréz / alamă	
WZ-A0-K23-04	starožitná mosaz / starožitná mosadz / antik bronz / alama antică	
WZ-A0-K23-05	hliník / hliník / alumínium / aluminiu	
WZ-A0-K23-06*	kartáčovaná ocel / kartáčovaná ocel / szálcsiszolt acél / oțel periat	
WZ-A0-K23-07	starožitné striebro / starožitné striebro / antik ezüst / argint antic	
WZ-A0-K23-20	černá matná / čierna matná / fekete matt / negru mat	

\*K dispozicii pro speciální objednávky / K dispozicii na speciálne objednávky / Külön megrendelésben kapható / Disponibil pentru comenzi speciale

Věšák K23-B0  
 Vešiak K23-B0  
 Fogas K23-B0  
 Agatator K23-B0

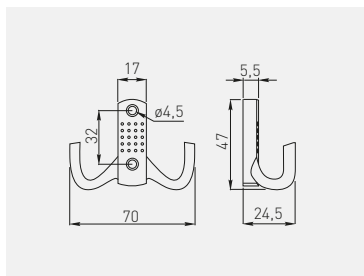

WZ-B0-K23-01	chrom / chróm / króm / crom	ZnAl
WZ-B0-K23-02	satén / satén / szatén / satin	
WZ-B0-K23-03	mosaz / mosadz / sárgaréz / alamă	
WZ-B0-K23-04	starožitná mosaz / starožitná mosadz / antik bronz / alama antică	
WZ-B0-K23-05	hliník / hliník / alumínium / aluminiu	
WZ-B0-K23-06*	kartáčovaná ocel / kartáčovaná ocel / szálcsiszolt acél / oțel periat	
WZ-B0-K23-07	starožitné striebro / starožitné striebro / antik ezüst / argint antic	
WZ-B0-K23-20	černá matná / čierna matná / fekete matt / negru mat	

\*K dispozicii pro speciální objednávky / K dispozicii na speciálne objednávky / Külön megrendelésben kapható / Disponibil pentru comenzi speciale



Věšák K24-A0  
 Vešiak K24-A0  
 Fogas K24-A0  
 Agatator K24-A0

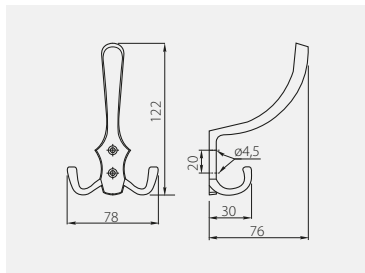

WZ-A0-K24-01	chrom / chróm / króm / crom	ZnAl
WZ-A0-K24-02	satén / satén / szatén / satin	
WZ-A0-K24-03	mosaz / mosadz / sárgaréz / alamá	
WZ-A0-K24-04	starožitná mosaz / starožitná mosadz / antik bronz / alama antică	
WZ-A0-K24-05	hliník / hliník / alumínium / aluminiu	
WZ-A0-K24-07	starožitné stříbro / starožitné striebro / antik ezüst / argint antic	
WZ-A0-K24-20	černá matná / čierna matná / feketete matt / negru mat	

Věšák K24-B0  
 Vešiak K24-B0  
 Fogas K24-B0  
 Agatator K24-B0

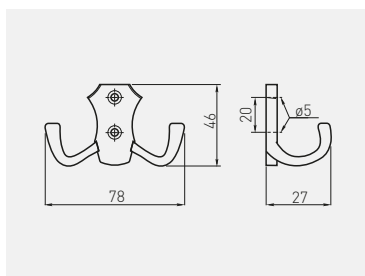

WZ-B0-K24-01	chrom / chróm / króm / crom	ZnAl
WZ-B0-K24-02	satén / satén / szatén / satin	
WZ-B0-K24-03	mosaz / mosadz / sárgaréz / alamá	
WZ-B0-K24-04	starožitná mosaz / starožitná mosadz / antik bronz / alama antică	
WZ-B0-K24-05	hliník / hliník / alumínium / aluminiu	
WZ-B0-K24-07	starožitné stříbro / starožitné striebro / antik ezüst / argint antic	
WZ-B0-K24-20	černá matná / čierna matná / feketete matt / negru mat	

Věšák K24-C0  
Vešiak K24-C0  
Fogas K24-C0  
Agatator K24-C0

CLASSIC

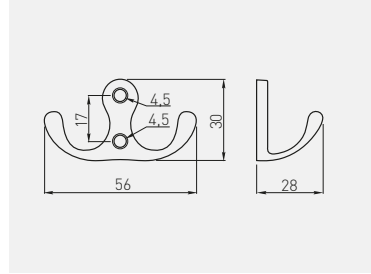

		
WZ-C0-K24-01	chrom / chróm / króm / crom	ZnAl
WZ-C0-K24-02	satén / satén / szatén / satin	
WZ-C0-K24-03	mosaz / mosadz / sárgaréz / alamă	
WZ-C0-K24-04	starožitná mosaz / starožitná mosadz / antik bronz / alama antică	
WZ-C0-K24-05	hliník / hliník / alumínium / aluminiu	
WZ-C0-K24-20	černá matná / čierna matná / fekete matt / negru mat	

Věšák MALAGA A0  
Vešiak MALAGA A0  
Fogas MALAGA A0  
Agatator MALAGA A0

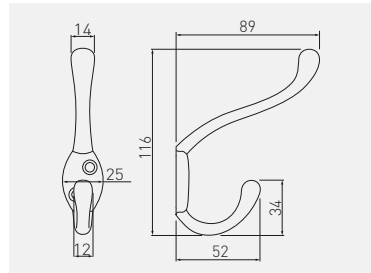

		
WA-MALAG-A0-01	chrom / chróm / króm / crom	hliník / hliník / alumínium / aluminiu
WA-MALAG-A0-02	satén / satén / szatén / satin	
WA-MALAG-A0-05	hliník / hliník / alumínium / aluminiu	
WA-MALAG-A0-20	černá / čierna / fekete / negru	

Věšák MALAGA B0  
 Vešiak MALAGA B0  
 Fogas MALAGA B0  
 Agatator MALAGA B0

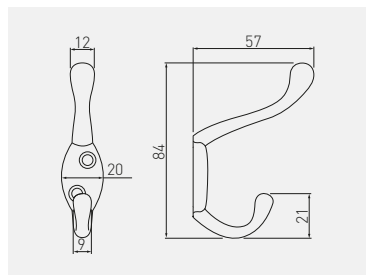

WA-MALAG-B0-01	chrom / chróm / króm / crom	hliník, hliník, aluminíum, aluminíu
WA-MALAG-B0-02	satén / satén / szatén / satin	
WA-MALAG-B0-05	hliník / hliník / alumínium / aluminíu	
WA-MALAG-B0-20	černá / čierna / fekete / negru	

Věšák MALAGA C0  
 Vešiak MALAGA C0  
 Fogas MALAGA C0  
 Agatator MALAGA C0

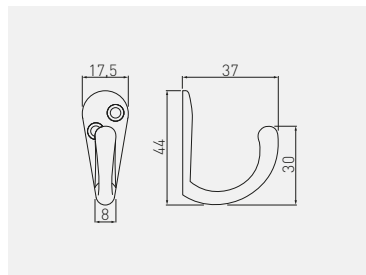

WZ-MALAG-C0-01	chrom / chróm / króm / crom	ZnAl
WZ-MALAG-C0-02	satén / satén / szatén / satin	
WZ-MALAG-C0-05	hliník / hliník / alumínium / aluminíu	
WZ-MALAG-C0-20	černá / čierna / fekete / negru	

Věšák E18  
Vešiak E18  
Fogas E18  
Agatator E18

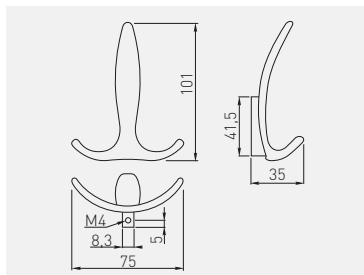

WZ-E-018-01	chrom / chróm / króm / crom	ZnAl
WZ-E-018-02	satén / satén / szatén / satin	
WZ-E-018-05	hliník / hliník / alumínium / aluminiu	
WZ-E-018-06	kartáčovaná ocel / kartáčovaná ocel / szálcsiszolt acél / oțel periat	
WZ-E-018-20M	černá matná / čierna matná / fekete matt / negru mat	

Věšák Coruna-D  
Vešiak Coruna-D  
Fogas Coruna-D  
Agatator Coruna-D

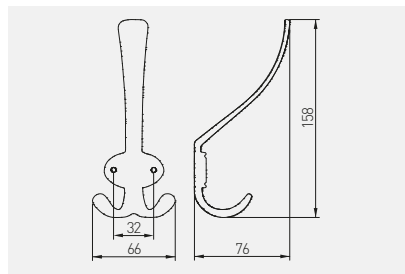

WZ-CORUNA-D-04	starožitná mosaz / starožitná mosadz / antik bronz / alama antică	ZnAl
WZ-CORUNA-D-07	starožitné striebro / starožitné striebro / antik ezüst / argint antic	
WZ-CORUNA-D-17	hnědá / hnedá / barna / maro	
WZ-CORUNA-D-20M	černá matná / čierna matná / fekete matt / negru mat	

Věšák Coruna-M  
 Vešiak Coruna-M  
 Fogas Coruna-M  
 Agatator Coruna-M

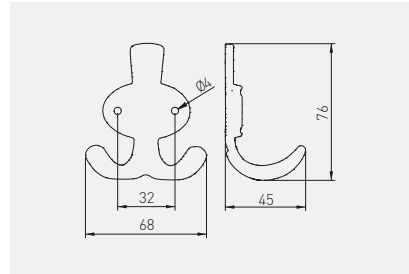

WZ-CORUNA-M-04	starožitná mosaz / starožitná mosadz / antik bronz / alama antică	ZnAl
WZ-CORUNA-M-07	starožitné striebro / starožitné striebro / antik ezüst / argint antic	
WZ-CORUNA-M-17	hnědá / hnedá / barna / maro	
WZ-CORUNA-M-20M	černá matná / čierna matná / feketete matt / negru mat	

Věšák MADRYT  
Vešiak MADRYT  
Fogas MADRYT  
Agatator MADRYT

CLASSIC

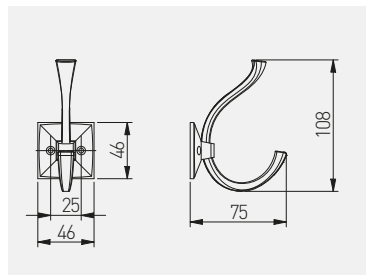

WZ-MADRYT-04	starožitná mosaz / starožitná mosadz / antik bronz / alama antică	ZnAl
WZ-MADRYT-07	starožitné striebro / starožitné striebro / antik ezüst / argint antic	
WZ-MADRYT-15	starožitná meď / starožitná meď / antik réz / cupru antic	
WZ-MADRYT-20M	černá matná / čierna matná / feketete matt / negru mat	

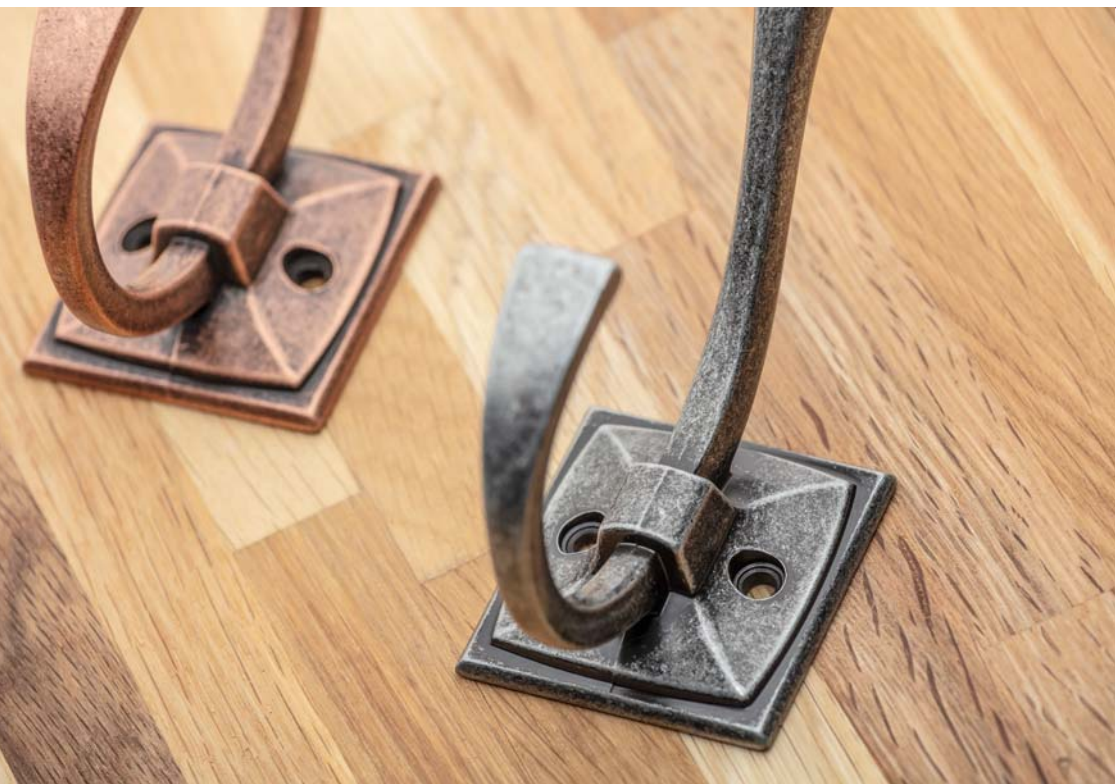

Věšák CRAFT  
Vešiak CRAFT  
Fogas CRAFT  
Agatator CRAFT

NEW

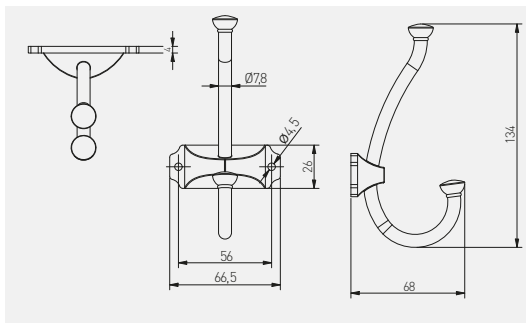

WZ-CRAFT-04	starožitná mosaz / starožitná mosadz / antik bronz / alama antică	ZnAl
WZ-CRAFT-07	starožitné striebro / starožitné striebro / antik ezüst / argint antic	
WZ-CRAFT-15	starožitná meď / starožitná meď / antik réz / cupru antic	
WZ-CRAFT-20M	černá matná / čierna matná / feketete matt / negru mat	

Věšák ORVIETO A0  
Vešiak ORVIETO A0  
Fogas ORVIETO A0  
Agatator ORVIETO A0

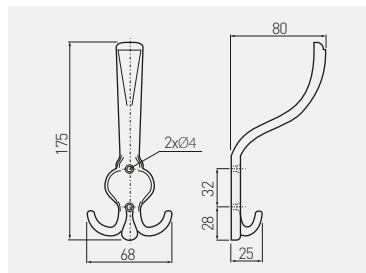

WZ-ORVIE-A0-09	starožitná kartáčovaná mosaz, starožitná kartáčovaná mosadz, antik szálcsiszolt sárgaréz, alamă periată antică	ZnAl
----------------	---	------

RETRO

Věšák K24  
 Vešiak K24  
 Fogas K24  
 Agatator K24

RETRO

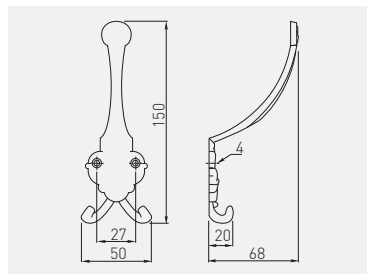

WZ-00-K24-04

starožitná mosaz / starožitná mosadz / antik bronz / alama antică

ZnAl

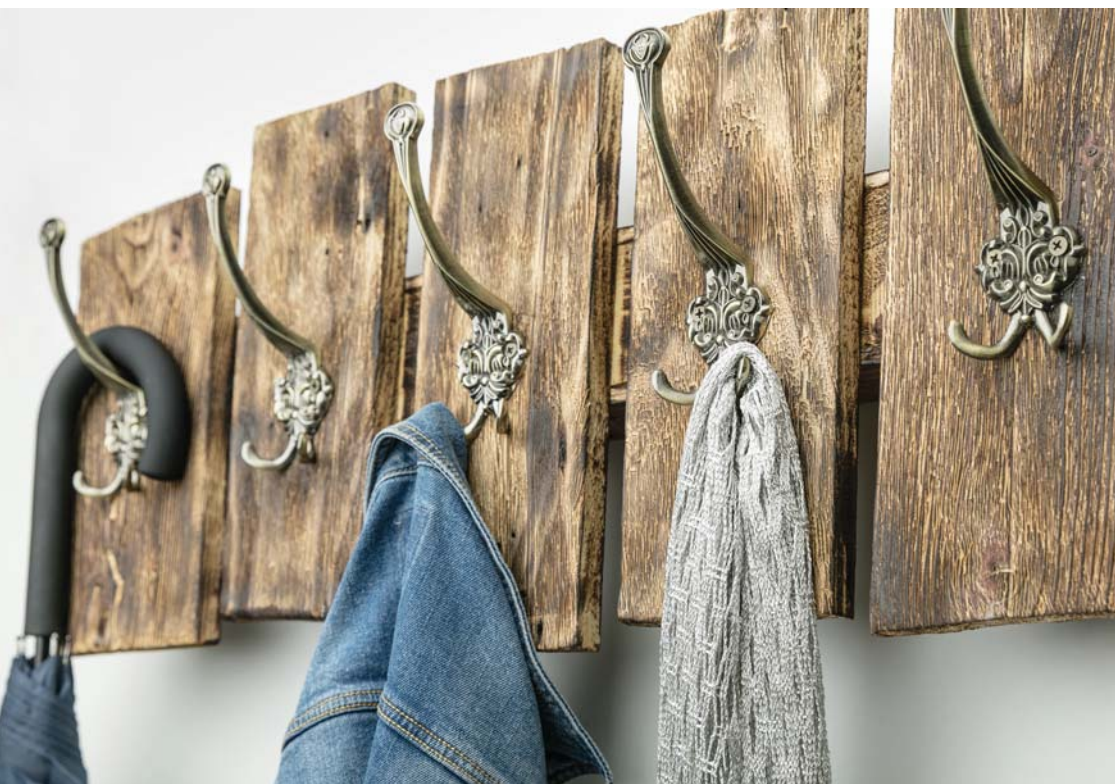



Věšák KID  
Vešiak KID  
Fogas KID  
Agatator KID



BLOCK



CLOUD



BALL



UNICORN

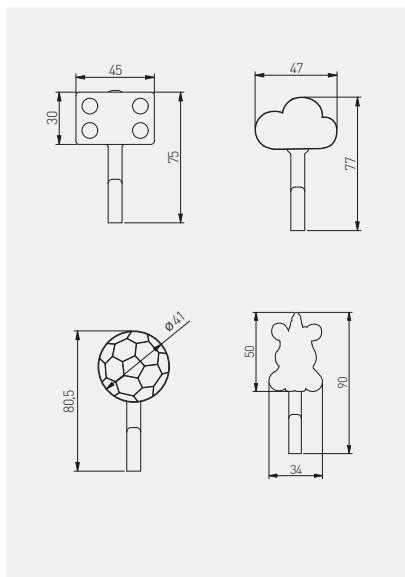

	zelená, zelená, zöld, verde	modrá modrá kék albastru	červená červená piros roșu	šedá, sivá, szürke, gri	žlutá žltá sárga galben	černá, bílá čierna, biela fekete, fehér negru, alb	růžová ružová rózsaszín roz	
block	WM-BLOCK-ZL	WM-BLOCK-NB	WM-BLOCK-CZ	-	-	-	-	pryž + ZnAl guma + ZnAl radiár + ZnAl cauciuc + ZnAl
cloud	-	WM-CLOUD-NB	-	WM-CLOUD-SZ	-	-	-	
unicorn	-	-	-	-	-	-	WM-UNICORN-RZ	
ball	-	-	-	-	-	WM-BALL-CZ-B	-	

Policová podpora BELT  
 Policová konzola BELT  
 Polctartó BELT  
 Suport raft BELT

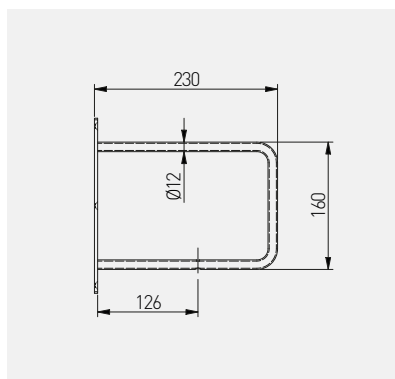

PP-BELT-20M



černá / čierna / fekete / negro



ocel / ocel / acél / oțel



30

Policová podpora FLAT  
 Policová konzola FLAT  
 Polctartó FLAT  
 Suport raft FLAT

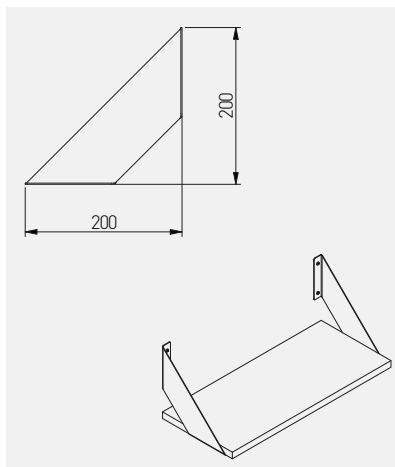

PP-FLAT-20M



černá / čierna / fekete / negro



ocel / ocel / acél / oțel





15

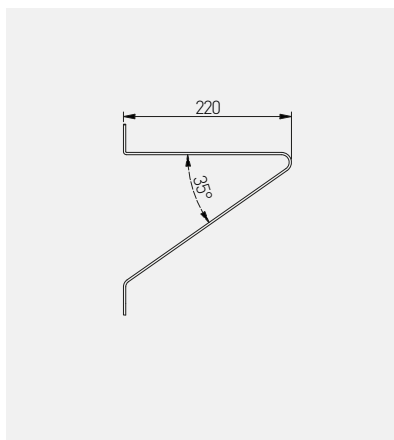

Policová podpěra GALA  
 Policová konzola GALA  
 Polctartó GALA  
 Suport raft GALA



			
PP-GALA-20M	černá / čierna / fekete / negru	ocel / ocel' / acél / oțel	30

Policová podpěra GINO  
 Policová konzola GINO  
 Polctartó GINO  
 Suport raft GINO

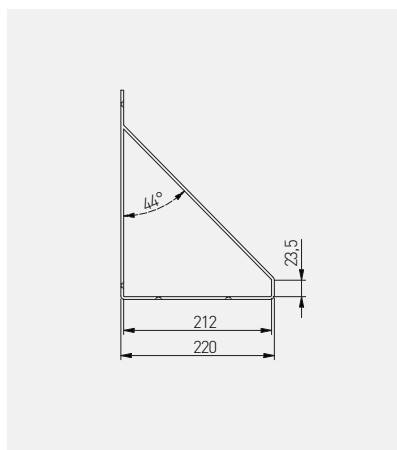

			
PP-GINO-20M	černá / čierna / fekete / negru	ocel / ocel' / acél / oțel	30



Policová podpěra INGRID  
 Policová konzola INGRID  
 Polctartó INGRID  
 Suport raft INGRID

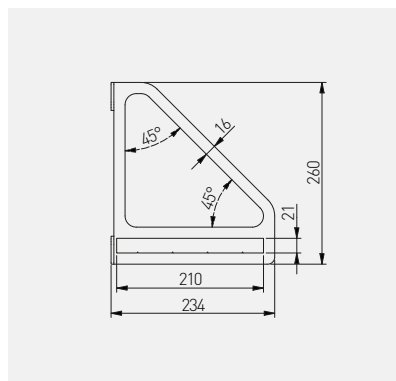

PP-INGRID-20M



černá / čierna / fekete / negru



ocel / ocel / acél / oțel



20

Policová podpěra NEO  
 Policová konzola NEO  
 Polctartó NEO  
 Suport raft NEO

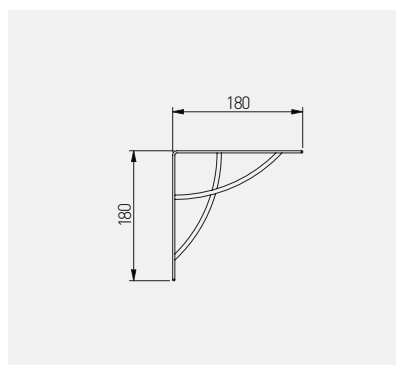

PP-NEO-20M



černá / čierna / fekete / negru



ocel / ocel / acél / oțel



20



Policová podpěra BAR  
 Policová konzola BAR  
 Polctartó BAR  
 Suport raft BAR

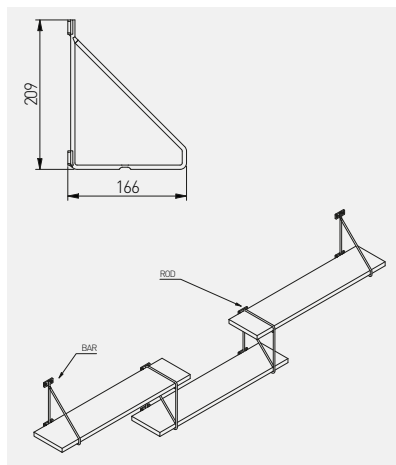

PP-BAR-20M

černá / čierna / fekete / negro

ocel / ocel / acél / oțel

20

Policová podpěra ROD  
 Policová konzola ROD  
 Polctartó ROD  
 Suport raft ROD

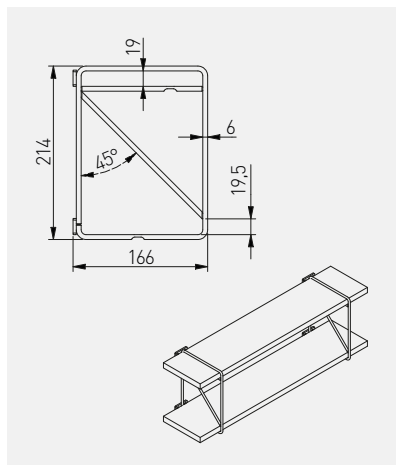

PP-ROD-20M

černá / čierna / fekete / negro

ocel / ocel / acél / oțel

20



Policová podpěra TREE  
 Policová konzola TREE  
 Polctartó TREE  
 Suport raft TREE

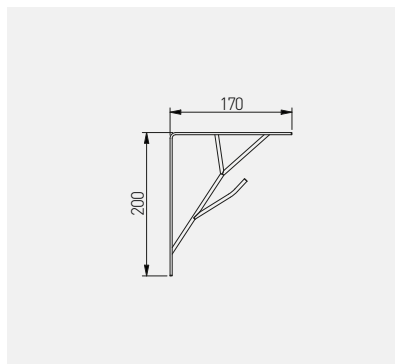

PP-TREE-20M



černá / čierna / fekete / negro



ocel / ocel' / acél / oțel



20

Policová podpěra WIRE  
 Policová konzola WIRE  
 Polctartó WIRE  
 Suport raft WIRE

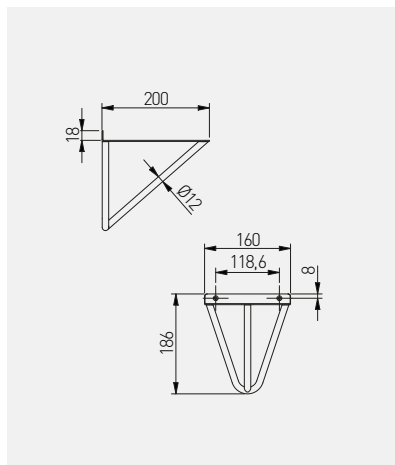

PP-WIRE-20M



černá / čierna / fekete / negro









ocel / ocel' / acél / oțel

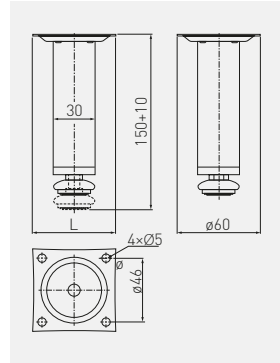

30

Noha BD-150  
 Nôžka BD-150  
 Állítható láb BD-150  
 Picior reglabil BD-150



				
NM-BD-150-01	150 + 10	chrom / chróm / króm / crom	ocel / ocel / acél / oțel	80
NM-BD-150-02		satén / satén / szatén / satin		

Noha BD-03  
 Nôžka BD-03  
 Állítható láb BD-03  
 Picior reglabil BD-03

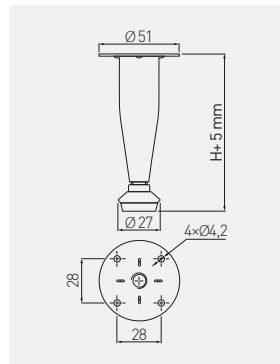

				
NM-BD-003-01	100 + 5	chrom / chróm / króm / crom	ocel / ocel / acél / oțel	100
NM-BD-003-02		satén / satén / szatén / satin		

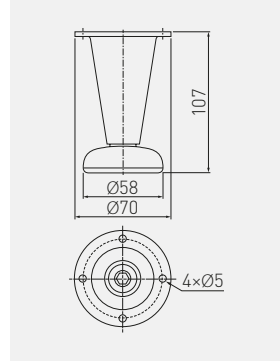

Noha BD-780  
 Nôžka BD-780  
 Bútorláb BD-780  
 Picior BD-780

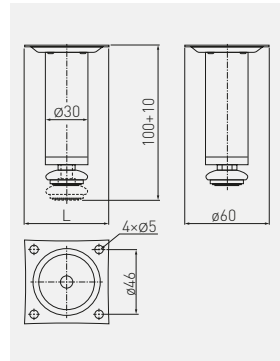

		 mm			
NM-BD-780-M1		107	chrom / chróm / króm / crom	ocel / ocel / acél / oțel	50
NM-BD-780-M2	satén / satén / szatén / satin				
NM-BD-780-M5	hliník / hliník / aluminium / aluminiu				

Noha BD-100  
 Nôžka BD-100  
 Állítható láb BD-100  
 Picior reglabil BD-100



		 mm			
NM-BD-100-01		100 + 10	chrom / chróm / króm / crom	ocel, ocel, acél, oțel	100
NM-BD-100-02	satén / satén / szatén / satin				
NM-BD-100-05	hliník / hliník / aluminium / aluminiu				
NM-BD-100-06	kartácovaná ocel / kartácovaná ocel / szálcsiszolt acél / oțel periat				

Noha BD-762  
 Nôžka BD-762  
 Állítható láb BD-762  
 Picior reglabil BD-762

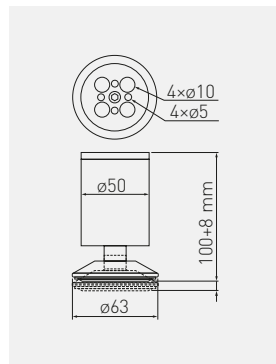

	 mm			
NM-BD-762-01	100 + 8	chrom / chróm / króm / crom	ZnAl + ocel	50
NM-BD-762-05		hliník / hliník / alumínium / aluminu	ZnAl + ocel ZnAl + acél ZnAl + oțel	

Noha BD-867  
 Nôžka BD-867  
 Bútorláb BD-781  
 Picior BD-867

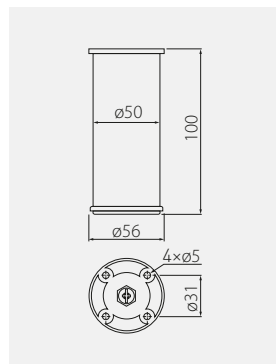

	 mm			
NM-BD867-100	100	hliník / hliník / alumínium / aluminu	hliník / hliník / alumínium / aluminu	50

Noha BD-868  
 Nôžka BD-868  
 Bútorláb BD-868  
 Picior BD-868

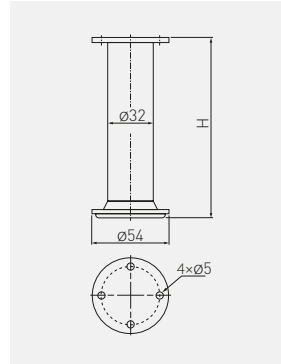

NM-BD868-100	100	hliník / hliník / alumínium / aluminiu	hliník / hliník / alumínium / aluminiu	50
NM-BD868-150	150			



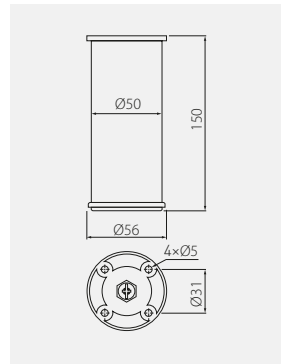

Noha BD-869  
 Nôžka BD-869  
 Bútorláb BD-869  
 Picior BD-869

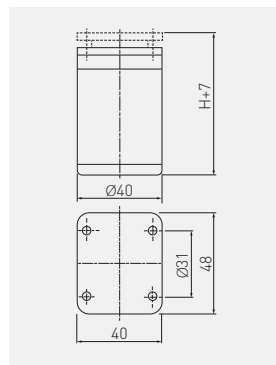

NM-BD869-150	150	hliník / hliník / alumínium / aluminiu	hliník / hliník / alumínium / aluminiu	50
--------------	-----	--	--	----



Noha DAP-77  
 Nôža DAP-77  
 Állítható láb DAP-77  
 Picior reglabil DAP-77

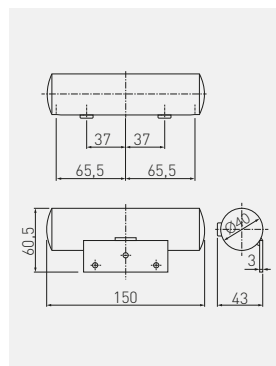

		 H mm			
NM-DAP77-60		60 + 7	hliník / hliník / aluminium / aluminiu	hliník + plast, hliník + plast, aluminium + műanyag, aluminium + plastic	
NM-DAP77-100		100 + 7			100
NM-DAP77-150		150 + 7			

Noha BAHIA  
 Nôžka BAHIA  
 Bútorláb BAHIA  
 Picior BAHIA



		 H mm		
NM-BAHIA40-150-01		43	chrom / chróm / króm / crom	50

Noha SQ-40  
 Nôžka SQ-40  
 Állítható láb SQ-40  
 Picior reglabil SQ-40

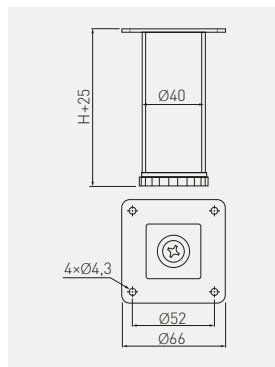

		 H mm			
NM-SQ40ADJ-060		60 + 25	chrom / chróm / króm / crom	ocel / ocel / acél / oțel	100
NM-SQ40ADJ-100		100 + 25	chrom / chróm / króm / crom		50

Noha SQA  
 Nôžka SQA  
 Állítható láb SQA  
 Picior reglabil SQA

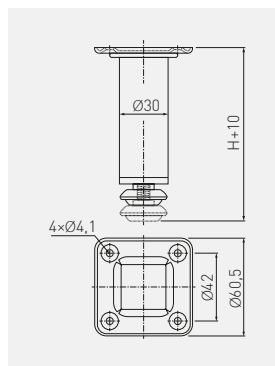

		 H mm			
NM-SQA100-01		100 + 10	chrom / chróm / króm / crom	ocel / ocel / acél / oțel	100
NM-SQA150-01*		150 + 10			

\*K dispozicii pro speciální objednávky / K dispozicii na speciálne objednávky / Külön megrendelésben kapható / Disponibil pentru comenzi speciale

Noha BD-727  
 Nôžka BD-727  
 Bútorláb BD-727  
 Picior BD-727

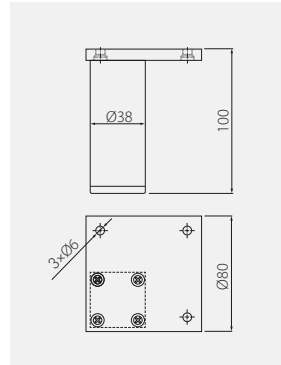

NM-BD727-100	100	hliník / hliník / aluminium / aluminiu	hliník / hliník / aluminium / aluminiu	50
--------------	-----	--	--	----

Noha BD-739  
 Nôžka BD-739  
 Bútorláb BD-739  
 Picior BD-739

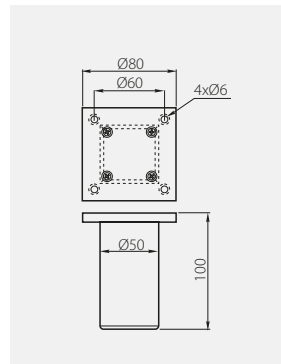





NM-BD-739-05	100	hliník / hliník / aluminium / aluminiu	hliník / hliník / aluminium / aluminiu	50
--------------	-----	--	--	----

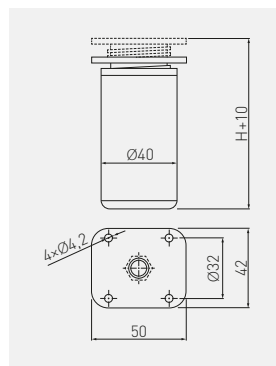

Noha DAK-27  
 Nôžka DAK-27  
 Állítható láb DAK-27  
 Picior reglabil DAK-27



	 H mm			
NM-DAK27-060	60 + 10	hliník, hliník, aluminium, aluminium	hliník + plast, hliník + plast, aluminium + müanyag, aluminium + plastic	100
NM-DAK27-080	80 + 10			
NM-DAK27-100	100 + 10			
NM-DAK27-120	120 + 10			
NM-DAK27-150	150 + 10			

Noha NACK  
 Nôžka NACK  
 Állítható láb NACK  
 Picior reglabil NACK

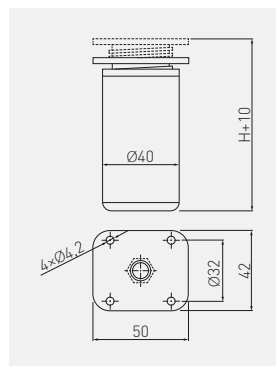

	 H mm			
NM-NACK27651-06	60 + 10	chrom / chróm / króm / crom	hliník + plast, hliník + plast, aluminium + müanyag, aluminium + plastic	100

Noha BD-01  
 Nôžka BD-01  
 Bútorláb BD-01  
 Píciór BD-01

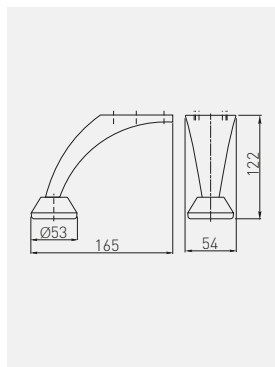

	 mm			
NM-BD-001-M1B	122	chrom / chróm / króm / crom	ocel / ocel / acél / oţel	80

Noha BD-712  
 Nôžka BD-712  
 Bútorláb BD-712  
 Píciór BD-712

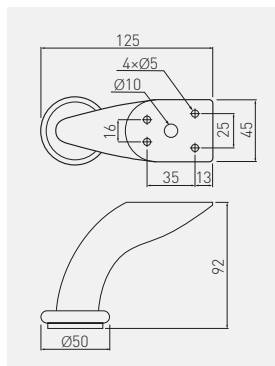

	 mm			
NM-BD-712-M1	92	chrom / chróm / króm / crom	ocel / ocel / acél / oţel	50

\*K dispozici pro speciální objednávky / K dispozici na speciálne objednávky / Külön megrendelésben kapható /  
 Disponibil pentru comenzi speciale

Noha STGY 135  
Nôžka STGY 135  
Bútorláb STGY 135  
Picior STGY 135

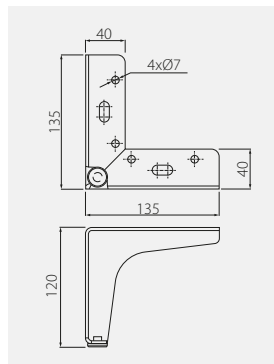

	H mm			
NM-STGY135-100-01	100	chrom / chróm / króm / crom	ocel + plast. ocel + plast. acél + műanyag, oţel + plastic	50
NM-STGY135-130-01*	130			
NM-STGY135-150-01*	150			40

\*K dispozicii pro speciální objednávky / K dispozícii na špeciálne objednávky / Külön megrendelésben kapható / Disponibil pentru comenzi speciale

Noha STOMP  
Nôžka STOMP  
Bútorláb STOMP  
Picior STOMP

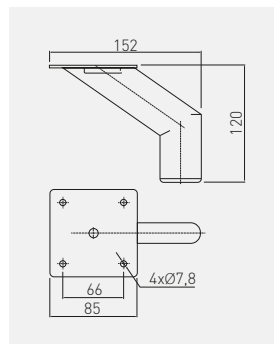

	H mm			
NM-STOMP-100-01*	100	chrom / chróm / króm / crom	ocel, ocel, acél, oţel	100
NM-STOMP-120-10*	120	bílá / biela / fehér / alb		
NM-STOMP-120-20		černá / čierna / fekete / negru		
NM-STOMP-130-01*	130	chrom / chróm / króm / crom		
NM-STOMP-130-06*		kartáčovaná ocel / kartáçovaná ocel / szálcsiszolt acél / oţel periat		
NM-STOMP-130-20*		černá / čierna / fekete / negru		
NM-STOMP-150-01*	150	chrom / chróm / króm / crom		60
NM-STOMP-160-01*	160	chrom / chróm / króm / crom		
NM-STOMP-160-06*		kartáčovaná ocel / kartáçovaná ocel / szálcsiszolt acél / oţel periat		
NM-STOMP-160-20*		černá / čierna / fekete / negru		

\*K dispozicii pro speciální objednávky / K dispozícii na špeciálne objednávky / Külön megrendelésben kapható / Disponibil pentru comenzi speciale

Noha NM-RONDA  
 Nôžka NM-RONDA  
 Bútorláb NM-RONDA  
 Picioar NM-RONDA

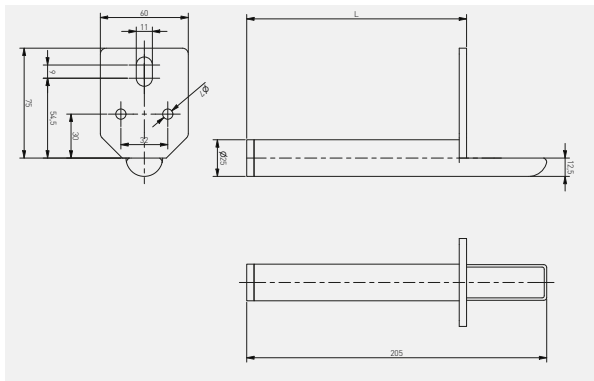

NM-RONDA-150-18	150	zlató / zlató / arany / aur	ocel + plast, ocel + plast, acél + műanyag, oțel + plastic
NM-RONDA-150-20M		černá matná / čierna matná / fekete matt / negru mat	
NM-RONDA-180-18	180	zlató / zlató / arany / aur	
NM-RONDA-180-20M		černá matná / čierna matná / fekete matt / negru mat	



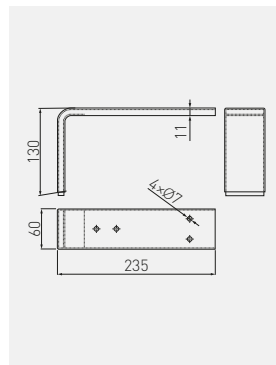

Noha MDN-D4  
 Nôžka MDN-D4  
 Bútorláb MDN-D4  
 Picioar MDN-D4

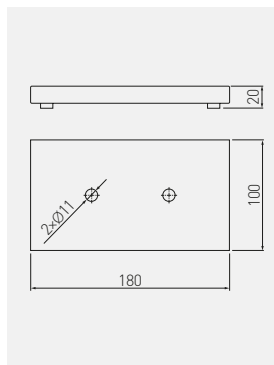

NM-MDN-D4-01	130	chrom / chróm / króm / crom	ocel / ocel / acél / oțel	25
--------------	-----	-----------------------------	---------------------------	----

Noha MDN-926  
 Nôžka MDN-926  
 Bútorláb MDN-926  
 Picior MDN-926



	 mm			
NM-MDN926-01	20	chrom / chróm / króm / crom	ocel / ocel' / acél / oțel	50

Noha MDN-927  
 Nôžka MDN-927  
 Bútorláb MDN-927  
 Picior MDN-927

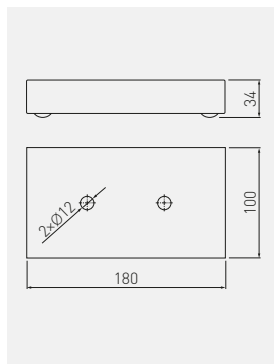

	 mm			
NM-MDN927-01	34	chrom / chróm / króm / crom	ocel / ocel' / acél / oțel	50

Noha MDN-941  
 Nôžka MDN-941  
 Bútorláb MDN-941  
 Picior MDN-941

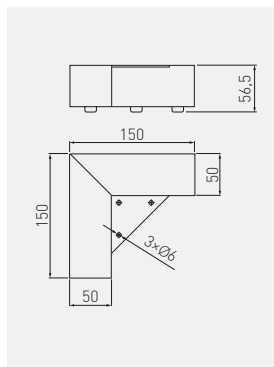

NM-MDN941-01	56 mm	chrom / chróm / króm / crom	ocel / ocel / acél / oțel	25

Kluzák WPJ výškove staviteľný  
 Kľzák WPJ s rektifikáciou  
 Állítható bútor csúszka WPJ  
 Picior reglabil WPJ

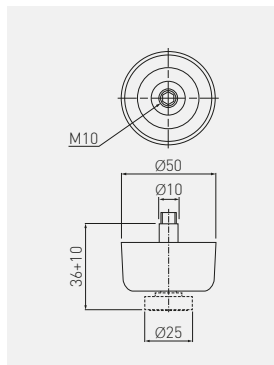

NM-WPJ22-D20	36 + 10 mm	černá / čierna / fekete / negru	plast / plast / műanyag / plastic	5

Hřebíkový kluzák SLZ  
 Klzák nábytku SLZ s jediným uchytením  
 Bútor felszögelhető csúszka SLZ  
 Picioar tip talpa simpla SLZ

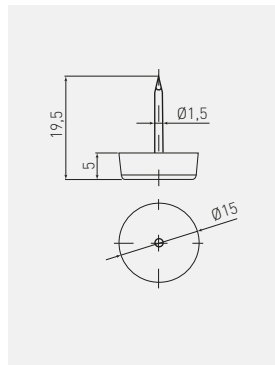

BP-SLZIGW-10



černá / čierna / fekete / negru



plast / plast / műanyag / plastic

Hřebíkový kluzák SLZ dvojitý  
 Klzák nábytku SLZ s dvojitým uchytením  
 Bútor felszögelhető duplacsúszka SLZ  
 Picioar tip talpa dubla SLZ

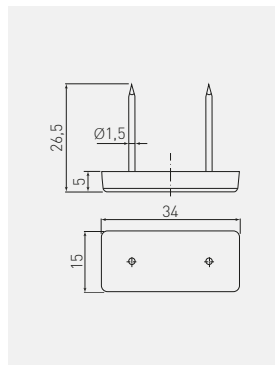

BP-SLZIGW-21



černá / čierna / fekete / negru



plast / plast / műanyag / plastic



250

Regulační nožka M6  
 Pätka M6, nastavitelná  
 Állítható láb M6  
 Picior M6 reglabil

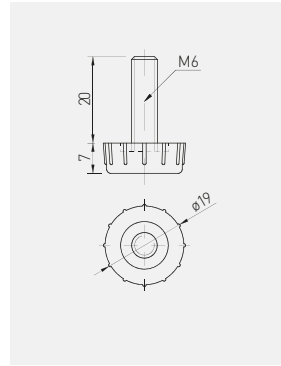

NM-STOPKA-M6



pozinkovaný  
 pozinkovaný  
 galvanizált  
 galvanizat



ocel + plast,  
 ocel + plast,  
 acél + műanyag,  
 oțel + plastic

Regulační nožka M6  
 Pätka M6, nastavitelná šestřhan  
 Állítható láb M6 hatszögletű  
 Picior M6 reglabil hexagonal

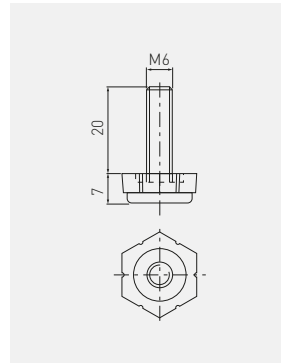

NM-STOPKSZESTK-M6



pozinkovaný  
 pozinkovaný  
 galvanizált  
 galvanizat



ocel + plast,  
 ocel + plast,  
 acél + műanyag,  
 oțel + plastic



250



Matice M6 natloukací+šroubovací  
 Natlkacia matica M6  
 Csatlakozó aljzat M6  
 Mufa pt picior reglabil M6



NM-MUFAWB-00



NM-MUFAWK-00

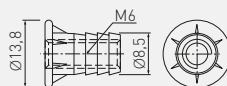

NM-MUFAWB-00

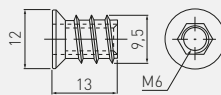

NM-MUFAWK-00

NM-MUFAWB-00	zatlókací zatlókacia becsavarható hüvely manşon înşurubabil	stříbrný, strieborná, ezüst, argint	ZnAl	2500
NM-MUFAWK-00	šroubovací skrútkovacia csavart înşurubat			4000

Rektifikační nožka DPD  
 Rektifikačná nôžka DPD  
 Állítható bútortaláb DPD  
 Picior reglabil DPD

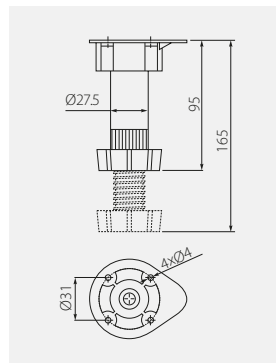

NM-DPD20-100	95 - 165 mm	60 kg	černá / čierna / fekete / negro	plast / plast / műanyag / plastic	200

Klip k noze DPD  
 Klip k nôžke DPD  
 Bútorláb clip DPD  
 Clemă pentru picior DPD

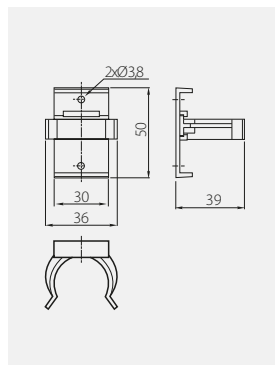

NM-KL-DPL-20



černá / čierna / fekete / negru



plast / plast / műanyag / plastic



1500

Rektifikační nožka DPA  
 Rektifikačná nôžka DPA  
 Bútorláb DPA  
 Picior DPA

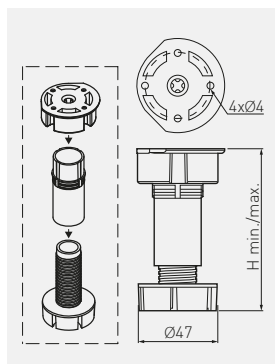

NM-DPA20-100



balení v krabici  
 balenie v krabici  
 dobozba csomagolva  
 ambalare în cutie



mm

87 – 120



kg

100



černá,  
 čierna,  
 fekete,  
 negru



plast,  
 plast,  
 műanyag,  
 plastic



250

NM-DPA20-150

137 – 170

200

NM-DPA20-100W

balení v plastovém sáčku  
 balenie v plastovom vrecku  
 csomagolás műanyag zacskóban  
 ambalare în pungă de plastic

87 – 120

100

NM-DPA20-150W

137 – 170

400

Klip k noze DPA  
 Klip k nôžke DPA  
 Bútorláb clip DPA  
 Clemă pentru picior DPA

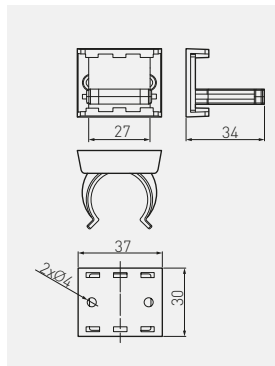

NM-KL-DPA-20



černá / čierna / fekete / negru



plast / plast / műanyag / plastic

Rektifikační nožka MLA-50  
 Rektifikačná nôžka MLA-50  
 Állítható bútorláb MLA-50  
 Picior reglabil MLA-50

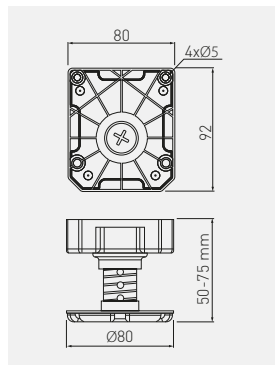

NM-MLA-50-75



50-75



450



černá / čierna / fekete / negru



plast / plast / műanyag / plastic



50

Rektifikační nožka MLA-65  
 Rektifikačná nôžka MLA-65  
 Állítható bútortláb MLA-65  
 Picior reglabil MLA-65

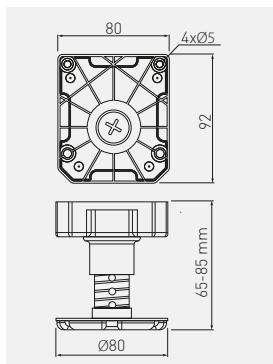

NM-MLA-65-85



65 - 85



450



černá / čierna / fekete / negro



plast / plast / műanyag / plastic



50

Rektifikační nožka MLA-85  
 Rektifikačná nôžka MLA-85  
 Állítható bútortláb MLA-85  
 Picior reglabil MLA-85

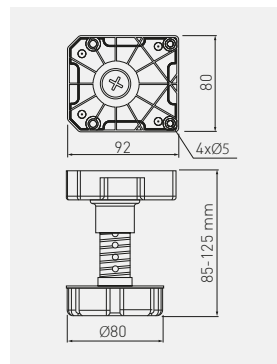

NM-MLA-85-125



85 - 125



450



černá / čierna / fekete / negro





plast / plast / műanyag / plastic

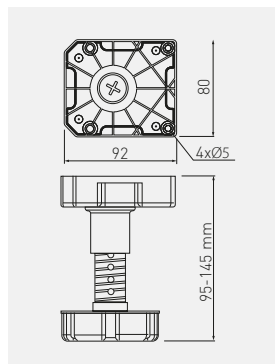

50

Rektifikační nožka MLA-95  
 Rektifikačná nôžka MLA-95  
 Állítható bútortláb MLA-95  
 Picior reglabil MLA-95



	 H mm	 kg			
NM-MLA-95-145	95 - 145	450	černá / čierna / fekete / negro	plast / plast / műanyag / plastic	100

Rektifikační nožka MLA-125  
 Rektifikačná nôžka MLA-125  
 Állítható bútortláb MLA-125  
 Picior reglabil MLA-125

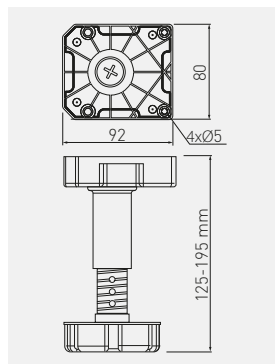

	 H mm	 kg			
NM-MLA-125-195	125 - 195	450	černá / čierna / fekete / negro	plast / plast / műanyag / plastic	50

Přichytka soklu pro nožky MLA  
 Klip pre nôžky MLA  
 Bútorláb clip MLA lábakhöz  
 Clema pentru picioare MLA

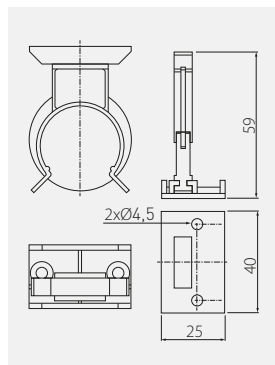

NM-MLA-KL



černá / čierna / fekete / negru



plast / plast / műanyag / plastic



100



Nastavitelná noha A6  
 Stolová noha A6  
 Állítható asztalláb A6  
 Picior reglabil A6

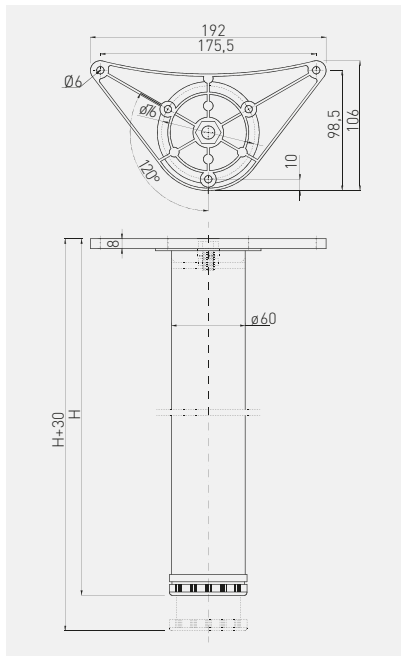

NM-A60710-01	710 + 30	chrom / chróm / króm / crom	ZnAl + ocel ZnAl + ocel ZnAl + acél ZnAl + oțel	4
NM-A60710-02		satén / satén / szatén / satin		
NM-A60710-05		hliník / hliník / alumínium / aluminiu		
NM-A60710-06*		kartáčovaná ocel / kartáčovaná ocel / szálcsiszolt acél / oțel periat		
NM-A60710-10N*		bílá / biela / fehéř / alb		
NM-A60710-20		černá / čierna / fekete / negru		
NM-A60710-80N		stříbrný / strieborná / ezüst / argint		
NM-A60820-01		820 + 30		
NM-A60820-02	satén / satén / szatén / satin			
NM-A60820-05	hliník / hliník / alumínium / aluminiu			
NM-A60820-06*	kartáčovaná ocel / kartáčovaná ocel / szálcsiszolt acél / oțel periat			
NM-A60820-10N*	bílá / biela / fehéř / alb			
NM-A60820-20*	černá / čierna / fekete / negru			
NM-A60820-80N*	stříbrný / strieborná / ezüst / argint			
NM-A60870-01*	1100 + 30			
NM-A60870-02*		satén / satén / szatén / satin		
NM-A60870-05*		hliník / hliník / alumínium / aluminiu		
NM-A60870-06*		kartáčovaná ocel / kartáčovaná ocel / szálcsiszolt acél / oțel periat		
NM-A60870-10N*		bílá / biela / fehéř / alb		
NM-A60870-20*		černá / čierna / fekete / negru		
NM-A60870-80N*		stříbrný / strieborná / ezüst / argint		
NM-A61100-01		1100 + 30		
NM-A61100-02	satén / satén / szatén / satin			
NM-A61100-05	hliník / hliník / alumínium / aluminiu			
NM-A61100-06	kartáčovaná ocel / kartáčovaná ocel / szálcsiszolt acél / oțel periat			
NM-A61100-10N*	bílá / biela / fehéř / alb			
NM-A61100-20*	černá / čierna / fekete / negru			

Nastavitelná noha NM-A80  
 Stolová noha NM-A80  
 Állítható asztalláb NM-A80  
 Picior reglabil NM-A80

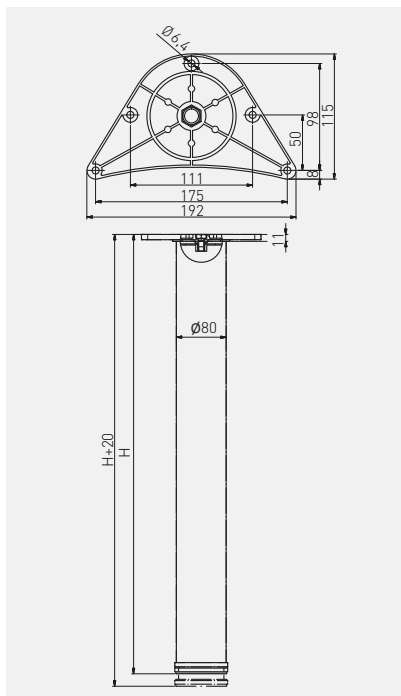









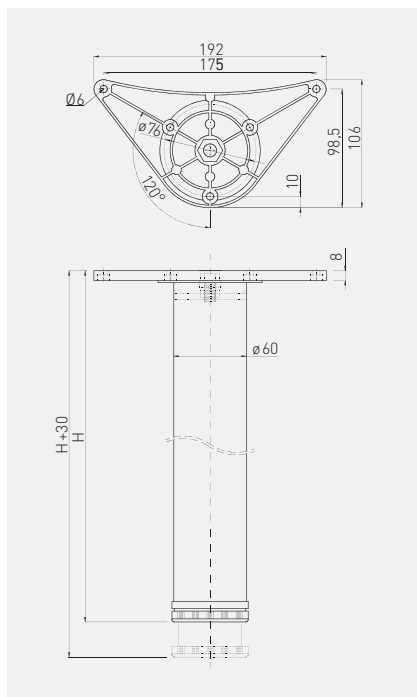



NM-A80710-01*	710 + 20	chrom / chróm / króm / crom	ZnAl + ocel ZnAl + ocel ZnAl + acél ZnAl + oțel	2
NM-A80710-02*		satén / satén / szatén / satin		
NM-A80710-03*		zlató / zlató / arany / aur		
NM-A80710-05*		hliník / hliník / aluminium / aluminiu		
NM-A80710-06*		kartáčovaná oceľ / kartáčovaná oceľ / szálcsiszolt acél / oțel periat		
NM-A80710-10*		bílá / biela / fehér / alb		
NM-A80710-20*		černá / čierna / fekete / negru		
NM-A80710-80*		stříbrný / strieborná / ezüst / argint		
NM-A80870-01*	870 + 20	chrom / chróm / króm / crom		
NM-A80870-02*		satén / satén / szatén / satin		
NM-A80870-03*		zlató / zlató / arany / aur		
NM-A80870-05*		hliník / hliník / aluminium / aluminiu		
NM-A80870-06*		kartáčovaná oceľ / kartáčovaná oceľ / szálcsiszolt acél / oțel periat		
NM-A80870-10*		bílá / biela / fehér / alb		
NM-A80870-20*		černá / čierna / fekete / negru		
NM-A80870-80*		stříbrný / strieborná / ezüst / argint		

\*K dispozici pro speciální objednávky / K dispozícii na špeciálne objednávky / Külön megrendelésben kapható / Disponibil pentru comenzi speciale



Stolová noha G6  
 Stolová noha G6  
 Állítható asztalláb G6  
 Picior reglabil G6





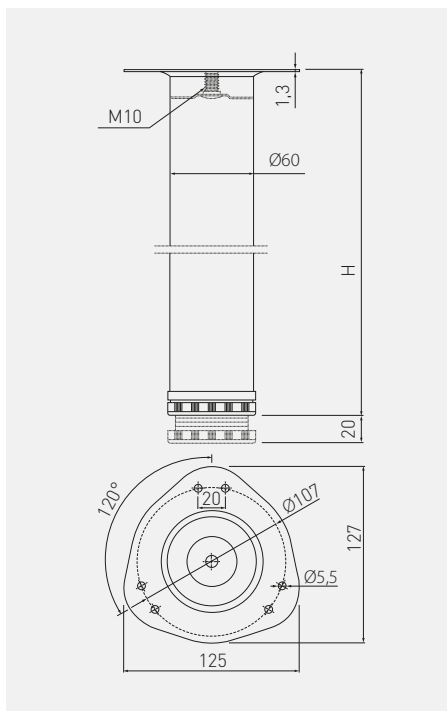

		 H mm					
NM-G60710-01N	710 + 30		chrom / chróm / króm / crom				
NM-G60710-02N			satén / satén / szatén / satin				
NM-G60710-05N			hliník / hliník / alumínium / aluminiu				
NM-G60710-06N			kartáčovaná ocel / kartáčovaná ocel / szálcsiszolt acél / oțel periat				
NM-G60710-10N*			bílá / biela / fehér / alb				
NM-G60710-20N			černá / čierna / fekete / negru				
NM-G60710-80N	820 + 30		stříbrný / strieborná / ezüst / argint				
NM-G60820-01N			chrom / chróm / króm / crom				
NM-G60820-05N			hliník / hliník / alumínium / aluminiu				
NM-G60820-06N			kartáčovaná ocel / kartáčovaná ocel / szálcsiszolt acél / oțel periat				
NM-G60820-10N*			bílá / biela / fehér / alb				
NM-G60820-20N			černá / čierna / fekete / negru				
NM-G61100-01N	1100 + 30		chrom / chróm / króm / crom				
NM-G61100-20N			černá / čierna / fekete / negru				

\*K dispozícii v bielej farbe na vyžádání / Na požiadanie k dispozícii v bielej farbe / Kérésre fehér színben is kapható / Disponibil în alb la cerere

Stolová noha S6  
 Stolová noha S6  
 Állítható asztalláb S6  
 Picior reglabil S6



		 H mm			
NM-S60710-01A	710 + 20		chrom / chróm / króm / crom	ocel, ocel, acél, oțel	4
NM-S60710-02A			satén / satén / szatén / satin		
NM-S60710-05A			hliník / hliník / aluminium / aluminiu		
NM-S60710-06A			kartáčovaná ocel / kartáčovaná ocel / szálcsiszolt acél / oțel periat		
NM-S60710-10A*			bílá / biela / fehér / alb		
NM-S60710-20A			černá / čierna / fekete / negru		
NM-S60820-01A	820 + 20		chrom / chróm / króm / crom		
NM-S60820-02A*			satén / satén / szatén / satin		
NM-S60820-05A			hliník / hliník / aluminium / aluminiu		
NM-S60820-06A*			kartáčovaná ocel / kartáčovaná ocel / szálcsiszolt acél / oțel periat		
NM-S60820-10A*			bílá / biela / fehér / alb		
NM-S60820-20A*			černá / čierna / fekete / negru		

\*K dispozicii pro speciální objednávky / K dispozicii na speciálne objednávky / Külön megrendelésben kapható / Disponibil pentru comenzi speciale

Noha F-50 skládací  
 Stolová noha F-50, skladacia  
 Összecsukható asztalláb F-50  
 Piciorul pliabil F-50

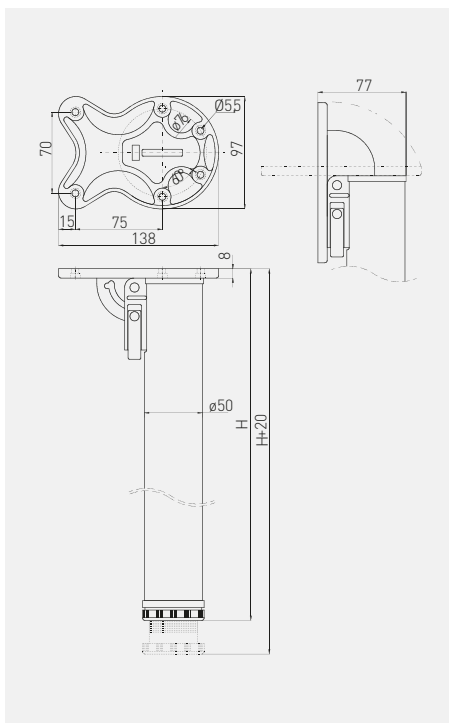

	  H mm		
NM-F50710-01	710 + 20	chrom / chróm / króm / crom	ZnAl + ocel + ABS ZnAl + ocel + ABS ZnAl + acél + ABS ZnAl + oțel + ABS
NM-F50710-06		kartáčovaná ocel / kartáčovaná ocel / szálcsiszolt acél / oțel periat	
NM-F50710-10		bílá / biela / fehér / alb	
NM-F50710-20		černá / čierna / feketete / negru	
NM-F50870-01	870 + 20	chrom / chróm / króm / crom	
NM-F50870-06		kartáčovaná ocel / kartáčovaná ocel / szálcsiszolt acél / oțel periat	
NM-F50870-10*		bílá / biela / fehér / alb	
NM-F50870-20		černá / čierna / feketete / negru	

\*K dispozici pro speciální objednávky / K dispozícii na špeciálne objednávky / Külön megrendelésben kapható / Disponibil pentru comenzi speciale

Šikmá noha X-LINE  
 Stolová noha X-LINE, šikmá  
 X-LINE ferde asztalláb  
 Picior pliabil X-LINE

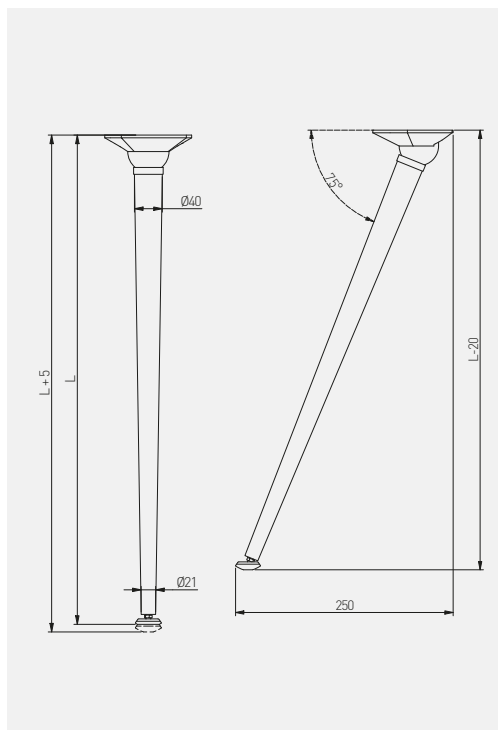







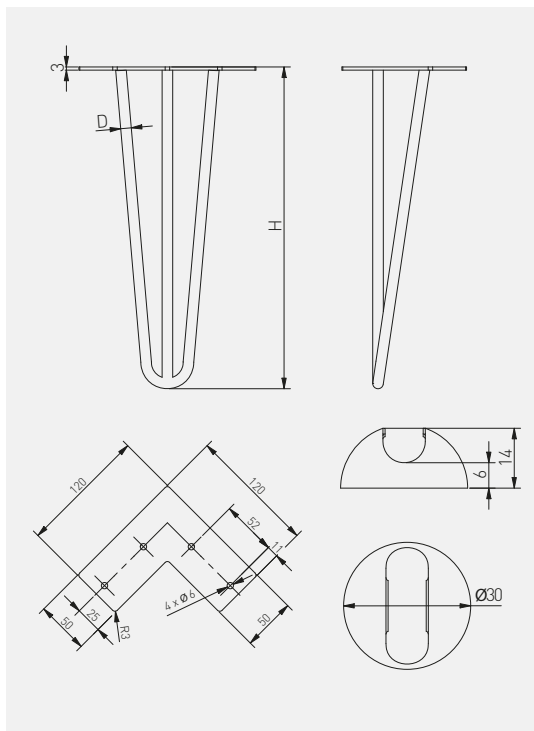

NM-X-LINE40710-01	710	chrom / chróm / króm / crom	ocel + plast, ocel + plast, acél + műanyag, oțel + plastic	4
NM-X-LINE40710-20		černá / čierna / fekete / negro		
NM-X-LINE40710-10		bílá / biela / fehér / alb		









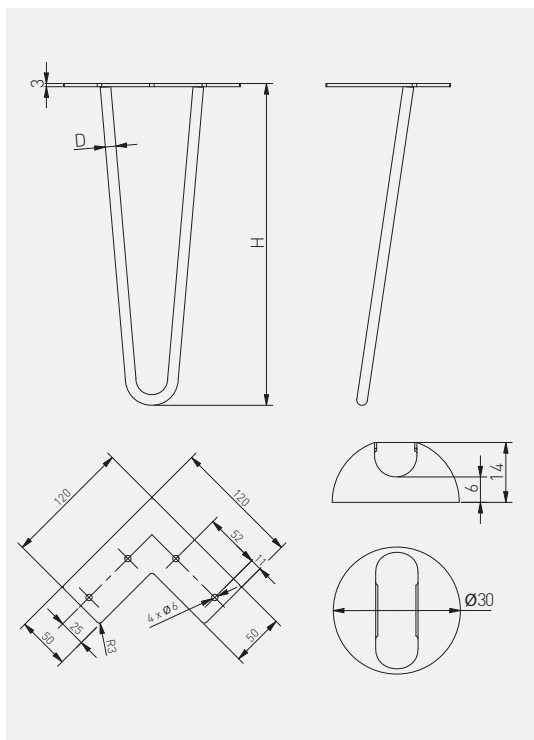

ARTO noha – hairpin  
 ARTO stolová noha - 3 ramena  
 ARTO asztalláb  
 Picior ARTO - ac de păr



	 H mm	$\varnothing D$ (mm)						
NM-ARTO-10-3R304-20M	304	$\varnothing 10$						
NM-ARTO-10-3R406-20M	406							
NM-ARTO-10-3R711-20M	711							
NM-ARTO-12-3R304-20M	304	$\varnothing 12$				černá matná, čierna matná, fekete matt, negru mat	ocel + plast, ocel + plast, acél + műanyag, oțel + plastic	4
NM-ARTO-12-3R406-20M	406							
NM-ARTO-12-3R711-20M	711							

ARTO noha – hairpin  
 ARTO Stolová noha - 2 ramena  
 ARTO asztalláb  
 Picior ARTO - ac de păr







	 H mm	 ØD (mm)				
NM-ARTO-10-2R304-20M	304	ø10	černá matná, čierna matná, fekete matt, negru mat			
NM-ARTO-10-2R406-20M	406					
NM-ARTO-10-2R711-20M	711					
NM-ARTO-12-2R304-20M	304	ø12				ocel + plast, ocel + plast, acél + műanyag, oțel + plastic
NM-ARTO-12-2R406-20M	406					
NM-ARTO-12-2R711-20M	711					

Podnož INDUSTRIA  
Podnož INDUSTRIA - H  
Industria keret  
Picioar cadru INDUSTRIA

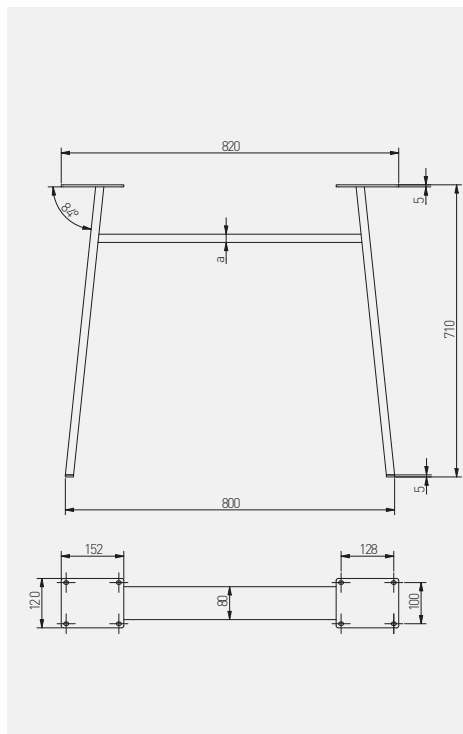

NEW



			<b>a</b> (mm)		
NM-INDUSTRIA-H20-710X820-20M*		černá matná, čierna matná, fekete matt, negru mat	20	ocel, ocel, acél, oțel	1
NM-INDUSTRIA-H40-710X820-20M*			40		

\*K dispozici pro speciální objednávky / K dispozicii na špeciálne objednávky / Külön megrendelésben kapható / Disponibil pentru comenzi speciale



Podnož INDUSTRIA  
Podnož INDUSTRIA - H  
Industria keret  
Picio cadru INDUSTRIA



NEW

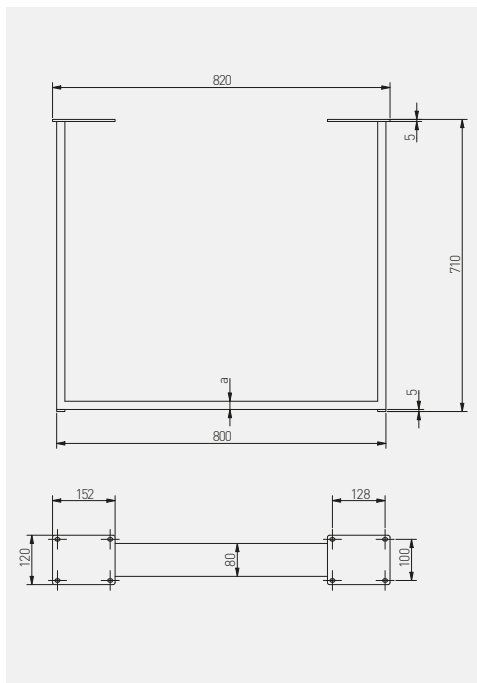

		a (mm)		
NM-INDUSTRIA-P20-710X820-20M*	černá matná / čierna matná / fekete matt / negru mat	20	ocel, ocel, acél, oțel	1
NM-INDUSTRIA-P40-710X820-20M*		40		
NM-INDUSTRIA-P80-710X820-20M*		80		

\*K dispozici pro speciální objednávky / K dispozici na špeciálne objednávky / Külön megrendelésben kapható / Disponibil pentru comenzi speciale

Podnož INDUSTRIA  
Podnož INDUSTRIA - H  
Industria keret  
Picio cadru INDUSTRIA



NEW

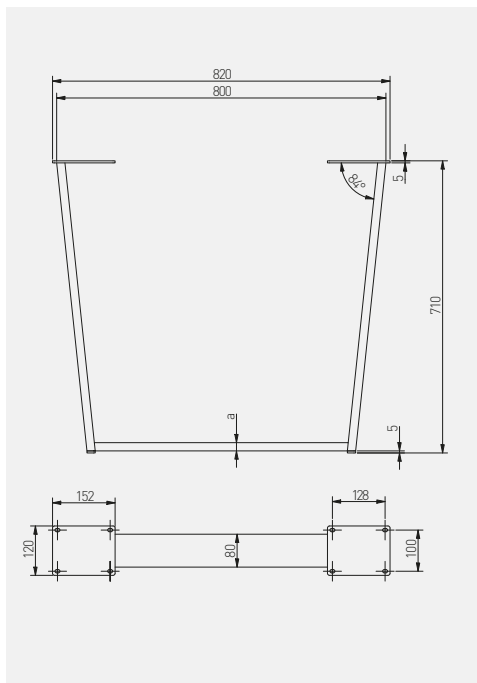

		<b>a</b> (mm)		
NM-INDUSTRIA-T20-710X820-20M*	černá matná / čierna matná / fekete matt / negru mat	20	ocel, ocel, acél, oțel	1
NM-INDUSTRIA-T40-710X820-20M*		40		

\*K dispozici pro speciální objednávky / K dispozicii na speciálne objednávky / Külön megrendelésben kapható / Disponibil pentru comenzi speciale

Podnož INDUSTRIA  
Podnož INDUSTRIA - H  
Industria keret  
Picio cadru INDUSTRIA



NEW

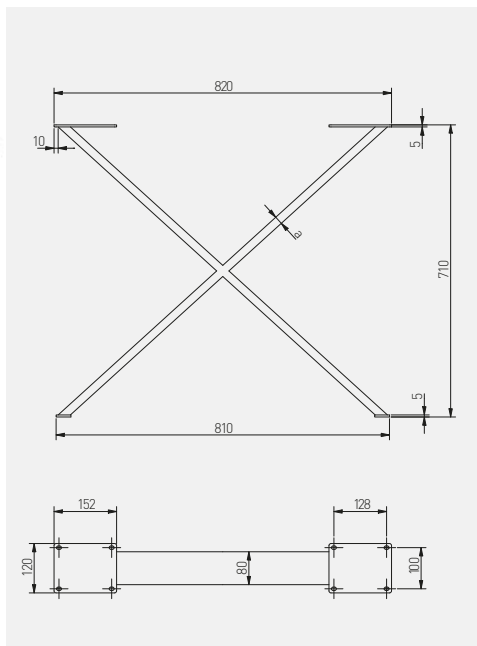

		a (mm)		
NM-INDUSTRIA-X20-710X820-20M*	černá matná / čierna matná / fekete matt / negro mat	20	ocel, ocel, acél, oțel	1
NM-INDUSTRIA-X40-710X820-20M*		40		
NM-INDUSTRIA-X80-710X820-20M*		80		

\*K dispozici pro speciální objednávky / K dispozici na špeciálne objednávky / Külön megrendelésben kapható / Disponibil pentru comenzi speciale

Noha NM-R46  
Hranatá stolová noha NM-R46  
Szögletes bútort láb  
Picio de mobilier pătrat

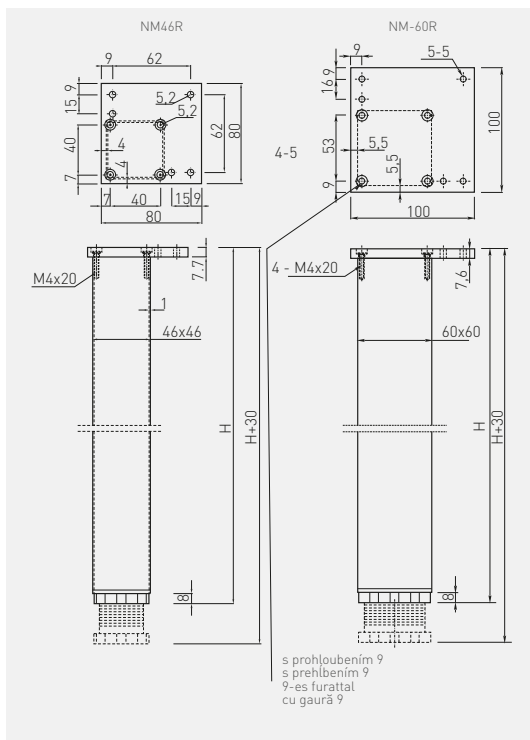
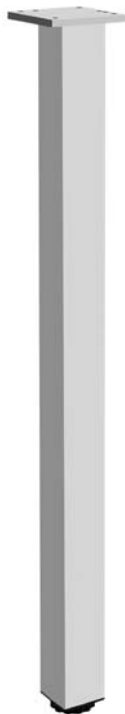

	 H mm		 
NM-46R710-05	710 + 30	hliník / hliník / alumínium / aluminiu	hliník, hliník, alumínium, aluminiu
NM-46R820-05	820 + 30		
NM-60R710-05	710 + 30		
NM-60R820-05	820 + 30		
NM-60R710-06	710 + 30	kartáčovaná ocel / kartáčovaná ocel / szálcsiszolt acél / oțel periat	4
NM-60R710-20		černá / čierna / fekete / negru	

Kancelářská podnož  
Kancelárska podnož  
Irodai asztalláb  
Picior birou

NEW

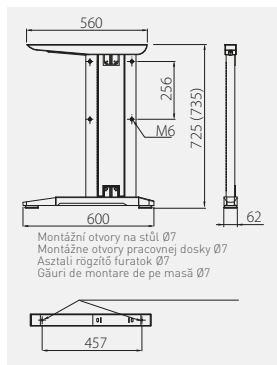





SB-A60X72-80	725 (735)	stříbrný / stříborná / ezüst / argint	ocel, ocel, acél, oțel	1
SB-A60x72-20M		černá matná / čierna matná / fekete matt / negru mat		1

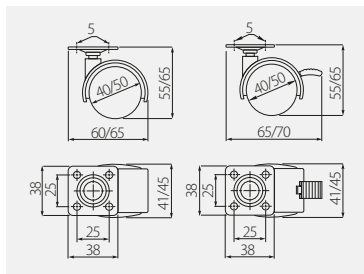





Nábytkové kolečko D20  
 Koliesko na nábytok KM-D20  
 KM-D20 bútorgörgő  
 Rotila mobilă KM-D20

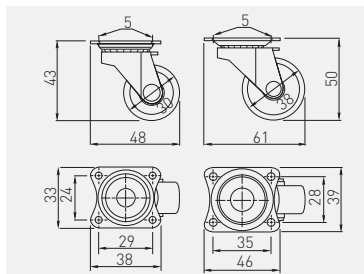

		 mm	 kg		
KM-00-40-D20	bez brzdy bez brzdy fék nélkül fără frână	40	18	černá, čierna, fekete, negru	ocel + plast, ocel + plast, acél + műanyag, oțel + plastic
KM-00-50-D20		50	22		
KM-0H-40-D20	s brzdou s brzdou fékkel cu frână	40	18		
KM-0H-50-D20		50	22		

Otočné kolečko KM 15  
 Koliesko otočné KM 15, plast  
 Bútorgörgő KM 15 műanyag  
 Rotila mobilă KM 15 din plastic



	 mm	 kg		
KM-015030-10	30	13,5	bílá / biela / fehér / alb	ocel + plast, ocel + plast, acél + műanyag, oțel + plastic
KM-015030-20	30		černá / čierna / fekete / negru	
KM-015038-10	38	16	bílá / biela / fehér / alb	

Gumový váleček KM 15  
 Koliesko otočné KM 15, guma  
 Gumi bútorgörgő KM 15  
 Rotila mobilier din cauciuc KM 15

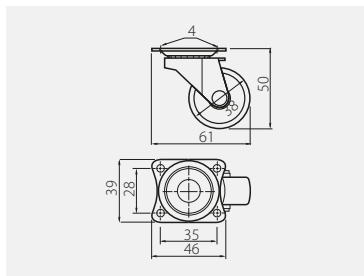

KM-015038-GM	38	16	černá / čierna / fekete / negru	pryž + ocel guma + ocel radír + acél cauciuc + oțel



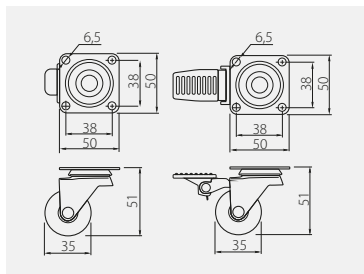

Kolečko na nábytek KMA 35  
 Koliesko na nábytok KMA 35  
 Bútorgörgő KMA 35  
 Rotila mobilă KMA 35

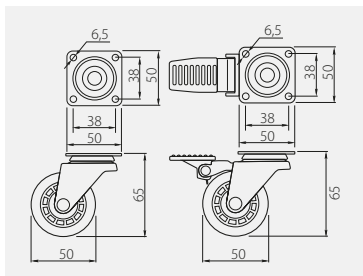

KM-A035MM-00	bez brzdy bez brzdy fék nélkül fără frână	35	25	průhledný / priehľadná / átlátszó / transparent	PC / PU
KM-A035MM-30				hnědá / hnedá / barna / maro	
KM-AH35MM-00	s brzdou s brzdou fékkel cu frână			průhledný / priehľadná / átlátszó / transparent	
KM-AH35MM-30	hnědá / hnedá / barna / maro				





Kolečko na nábytek KMA 50  
 Koliesko na nábytok KMA 50  
 Bútorgörgő KMA 50  
 Rotila mobilă KMA 50

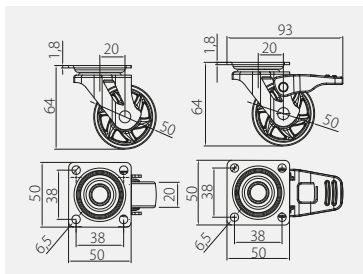

					
		mm	kg		
KM-A050MM-00	bez brzdy bez brzdy fék nélkül fără frână	50	35	průhledný / priehľadná / átlátszó / transparent	PC / PU
KM-A050MM-30				hnědá / hnedá / barna / maro	
KM-AH50MM-00	s brzdou s brzdou fékkel cu frână			průhledný / priehľadná / átlátszó / transparent	
KM-AH50MM-30				hnědá / hnedá / barna / maro	

Kolečko na nábytek SHIFT 50  
 Koliesko na nábytok SHIFT 50  
 Bútorgörgő SHIFT 50  
 Rotila mobilă SHIFT 50



					
		mm	kg		
KM-B050MM-00	bez brzdy bez brzdy fék nélkül fără frână	50	30	průhledný / priehľadná / átlátszó / transparent	PC / PU
KM-B050MM-30				hnědá / hnedá / barna / maro	
KM-BH50MM-00	s brzdou s brzdou fékkel cu frână			průhledný / priehľadná / átlátszó / transparent	
KM-BH50MM-30				hnědá / hnedá / barna / maro	



Kolečko na nábytek SHIFT 75  
 Koliesko na nábytok SHIFT 75  
 Bútorgörgő SHIFT 75  
 Rotila mobilă SHIFT 75

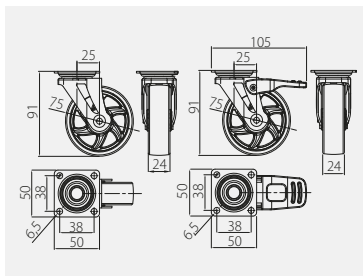

KM-B075MM-00	bez brzdy bez brzdy fék nélkül fără frână	75	40	průhledný / priehľadná / átlátszó / transparent	PC / PU
KM-B075MM-30				hnědá / hnedá / barna / maro	
KM-BH75MM-00	s brzdou s brzdou fékkel cu frână			průhledný / priehľadná / átlátszó / transparent	
KM-BH75MM-30	hnědá / hnedá / barna / maro				



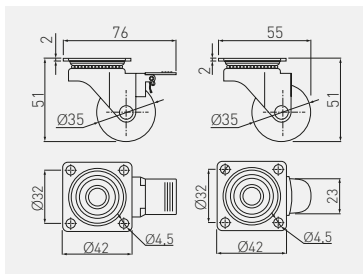

Kolečko na nábytek BRAZYLIA 35  
 Koliesko na nábytok BRAZYLIA 35  
 Bútorgörgő BRAZYLIA 35  
 Rotila mobilă BRAZYLIA 35

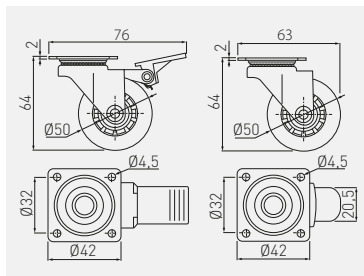

KM-RD-35-SF	bez brzdy bez brzdy fék nélkül fără frână	35	30	průhledný / priehľadná / átlátszó / transparent	PC, PU
KM-RD-35-SF-20				černá / čierna / fekete / negru	
KM-RD-35-CF	s brzdou s brzdou fékkel cu frână			průhledný / priehľadná / átlátszó / transparent	
KM-RD-35-CF-20	černá / čierna / fekete / negru				





Kolečko na nábytek BRAZYLIA 50  
 Koliesko na nábytok BRAZYLIA 50  
 Bútorgörgő BRAZYLIA 50  
 Rotila mobilă BRAZYLIA 50

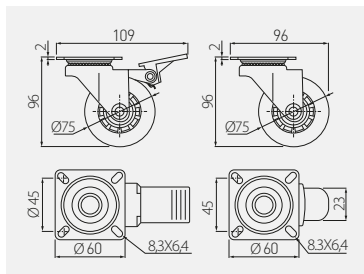

					
KM-RD-50-SF	bez brzdý bez brzdý fék nélkül fără frână	50	40	průhledný / priehľadná / átlátszó / transparent	PC, PU
KM-RD-50-SF-20				černá / čierna / fekete / negru	
KM-RD-50-CF	s brzdou s brzdou fékkel cu frână			průhledný / priehľadná / átlátszó / transparent	
KM-RD-50-CF-20	černá / čierna / fekete / negru				







Kolečko na nábytek BRAZYLIA 75  
 Koliesko na nábytok BRAZYLIA 75  
 Bútorgörgő BRAZYLIA 75  
 Rotila mobilă BRAZYLIA 75

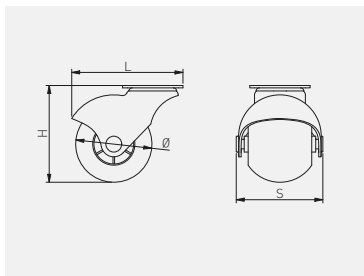

					
KM-RD-75-SF	bez brzdý bez brzdý fék nélkül fără frână	75	64	průhledný / priehľadná / átlátszó / transparent	PC, PU
KM-RD-75-SF-20				černá / čierna / fekete / negru	
KM-RD-75-CF	s brzdou s brzdou fékkel cu frână			průhledný / priehľadná / átlátszó / transparent	
KM-RD-75-CF-20	černá / čierna / fekete / negru				







Kolečko na nábytek SPAIN  
 Koliesko na nábytok SPAIN  
 Bútorgörgő SPAIN  
 Rotila mobilă SPAIN

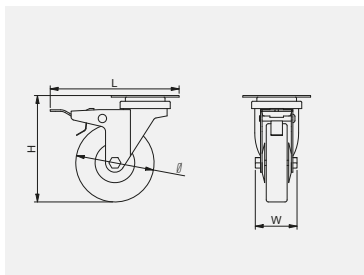

	 mm	 HxLxS mm	 kg ↓		
KM-SPAIN-40MM-18	40	53 x 62 x 47	15	šedá, sivá, szürke, gri	prýž + ocel guma + ocel radír + acél cauciuc + oțel
KM-SPAIN-50MM-18	50	61 x 70 x 54	20		

Kolečko GREYROLL  
 Koliesko GREYROLL  
 Bútorgörgő GREYROLL  
 Rotila GREYROLL



		 mm	 LxHxW mm	 kg ↓		
KM-GREYROLL-50mm-BH	bez brzdou bez brzdou fék nélkül fără frână	50	72 x 72 x 39	40	šedá, sivá, szürke, gri	prýž + ocel guma + ocel radír + acél cauciuc + oțel
KM-GREYROLL-75mm-BH		75	98 x 104 x 42	55		
KM-GREYROLL-50mm-ZH	s brzdou s brzdou fékkel cu frână	50	94 x 72 x 39	40		
KM-GREYROLL-75mm-ZH		75	117 x 104 x 42	55		

**SYSTEMY POSUVNÝCH DVEŘÍ**  
**SYSTEMY POSUVNÝCH DVEŘÍ**  
**TOLÓAJTÓ RENDSZEREK**  
**SISTEME DE UȘI CULISANTE**

Spodní pojezdové systémy  
Spodné pojezdové systémy  
Alul futó rendszerek  
Sisteme de rulare de jos

511 – 540

Horní pojezdové systémy  
Horné pojezdové systémy  
Felső rendszerek  
Sisteme de rulare superioare

541 – 545





# SEZNAMTE SE S KONFIGURÁTOREM POSUVNÝCH DVEŘÍ GTV ZOZNÁMTE SA S KONFIGURÁTOROM SKRÍŇ A POSUVNÝCH DVERÍ GTV FEDEZD FEL A GTV SZEKRÉNY ÉS TOLÓAJTÓ KONFIGURÁTORT DESCOPERIȚI CONFIGURATORUL DE DULAPURI ȘI UȘI GLISANTE GTV

Pokud si chcete svou každodenní práci spojenou s projektováním dveří usnadnit, máme pro Vás výhodné řešení - konfigurátor skříní a posuvných dveří GTV. Konfigurátor rovněž ocení truhlářské velkoobchody, výrobci vestavných skříní. Výstupem konfigurátoru je PDF dokument obsahující veškeré technické informace požadované skříně.

Ak chcete, aby bola vaša každodenná práca s navrhovaním skríň jednoduchšia, máme skvelé riešenie – konfigurátor skríň a posuvných dverí GTV. Ide o ľahký a intuitívny nástroj, ktorý zlepší a urýchli prácu každého stolára. Konfigurátor môžu využívať aj veľkoobchody s nábytkom, firmy a továrne vyrábajúce skrine. Konfigurátor skríň GTV umožňuje získať podrobné zhrnutie v PDF súbore, ktorý obsahuje technické informácie o skrini. Záverečná správa uľahčuje nákup potrebných materiálov.

Ha meg szeretné könnyíteni a szekrények tervezésével kapcsolatos mindennapi munkádat, van egy nagyszerű megoldásunk - a GTV szekrény- és tolóajtó konfigurátor. Egy egyszerű és intuitív eszköz, amely segíti és felgyorsítja bármely asztalos munkáját. A konfigurátort bútornagykereskedők, szekrényeket gyártó vállalatok és gyárak is használhatják. A GTV szekrénykonfigurátor a szekrény műszaki adatait tartalmazó pontos összefoglalót generál PDF-fájl formátumban. A végső összefoglaló megkönnyíti a szükséges anyagok beszerzését.

Dacă doriți să vă ușurați munca zilnică de proiectare a dulapurilor, avem o soluție excelentă - configuratorul de dulapuri și uși glisante GTV. Acesta este un instrument ușor și intuitiv care va simplifica și accelera munca oricărui tâmplar. Configuratorul poate fi utilizat și de către angroșiștii care comercializează mobilier, companiile și fabricile care produc dulapuri. Configuratorul de dulapuri GTV vă permite să primiți un rezumat detaliat într-un fișier PDF cu informații tehnice despre dulap. Raportul final facilitează achiziționarea materialelor de care aveți nevoie.



Madlo ERGO  
 Madlo ERGO  
 Fogantyú profil ERGO  
 Maner ERGO

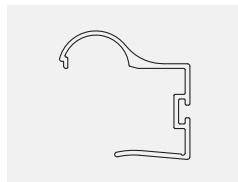

A-R18ERG-270-05	2700	hliník / hliník / alumíniu / aluminiu	hliník, hliník, alumíniu, aluminiu
A-R18ERG-270-90		šampaňské / šampaňské / pezsgő / șampanie	
A-R18ERG-270-20M		černá matná / čierna matná / matt fekete / negru mat	



Madlo ERGO 16  
 Madlo ERGO 16  
 Fogantyú profil ERGO 16  
 Maner ERGO 16

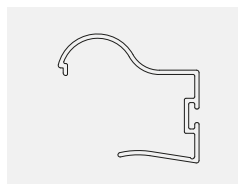

A-R16ERG-220-05	2200	hliník / hliník / alumíniu / aluminiu	hliník, hliník, alumíniu, aluminiu
A-R16ERG-230-50	2300	hliník / hliník / alumíniu / aluminiu	
A-R16ERG-270-50	2700	hliník / hliník / alumíniu / aluminiu	
A-R16ERG-270-90*	2700	šampaňské / šampaňské / pezsgő / șampanie	



\*Do vyprodání zásob / Do vyprodania zásob / Arnic a készletek el nem fogynak / Până la epuizarea stocurilor

Madlo GEO 18  
 Madlo GEO 18  
 Fogantyú profil GEO 18  
 Maner GEO 18

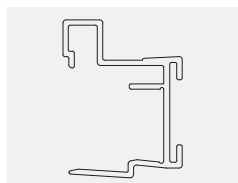

A-R18GEO2-270-05*	2700	hliník / hliník / alumíniu / aluminiu	hliník / hliník / alumíniu / aluminiu







\*K dispozici pro speciální objednávky / K dispozícii na špeciálne objednávky / Külön megrendelésben kapható / Disponibil pentru comenzi speciale



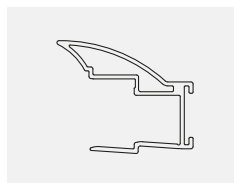

Madlo NOVO 2  
 Madlo NOVO 2  
 Fogantyú profil NOVO 2  
 Maner NOVO 2



	 L mm		
A-RNOV2-270-05	2700	hliník / hliník / alumínium / aluminiu	hliník, hliník, alumínium, aluminiu
A-RNOV2-270-10		bílá / biela / fehér / alb	
A-RNOV2-270-20M		černá matná / čierna matná / matt fekete / negru mat	
A-RNOV2-270-90		šampaňské / șampanské / pezsgő / șampanie	



Madlo NOVO S  
 Madlo NOVO S  
 Fogantyú profil NOVO S  
 Maner NOVO S

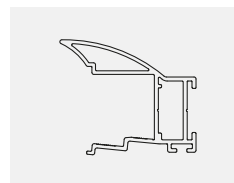

	 L mm		
A-R18NOVS-270-05	2700	hliník / hliník / alumínium / aluminiu	hliník, hliník, alumínium, aluminiu
A-R18NOVS-270-10		bílá / biela / fehér / alb	
A-R18NOVS-270-20M		černá / čierna / fekete / negru	
A-R18NOVS-270-90		šampaňské / șampanské / pezsgő / șampanie	



Madlo NOVO S 19  
 Madlo NOVO S 19  
 Fogantyú profil NOVO S 19  
 Maner NOVO S 19

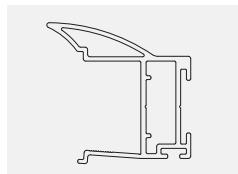

	 L mm		
A-R19NOVS-300-05*	3000	hliník / hliník / alumínium / aluminiu	hliník / hliník / alumínium / aluminiu



\*Do vyprodání zásob / Do vyprodania zásob / Amíg a készletek el nem fogynak / Până la epuizarea stocurilor

Madlo CARO  
 Madlo CARO  
 Fogantyú profil CARO  
 Maner CARO

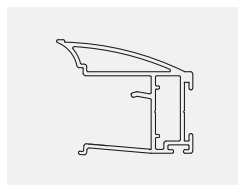



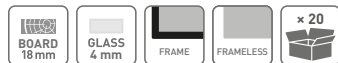

	 L mm		
A-R18CARO-270-05	2700	hliník / hliník / alumínium / aluminiu	hliník, hliník, alumínium, aluminiu
A-R18CARO-270-90		šampaňské / šampaňské / pezsgő / şampanie	

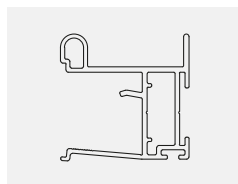

Madlo VISTA  
 Madlo VISTA  
 Fogantyú profil VISTA  
 Maner VISTA



	 L mm		
A-R18VIS-270-05	2700	hliník / hliník / alumínium / aluminiu	hliník, hliník, alumínium, aluminiu
A-R18VIS-270-20M		černá matná / čierna matná / matt fekete / negru mat	
A-R18VIS-270-90		šampaňské / šampaňské / pezsgő / şampanie	

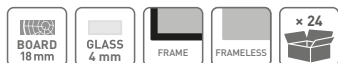

Madlo NERO  
 Madlo NERO  
 Fogantyú profil NERO  
 Maner NERO

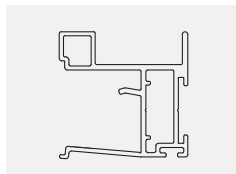

	 mm		
A-R18NERO-270-05	2700	hliník / hliník / alumínium / aluminiu	hliník, hliník, alumínium, aluminiu
A-R18NERO-270-10		bílá / biela / fehér / alb	
A-R18NERO-270-20M		černá / čierna / feketé / negru	
A-R18NERO-270-90		šampaňské / šampanské / pezsgő / šampanie	

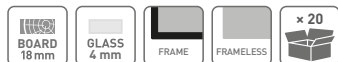

Madlo NERO 19  
 Madlo NERO 19  
 Fogantyú profil NERO 19  
 Maner NERO 19

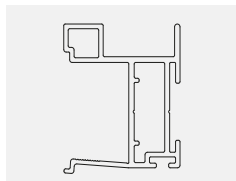

	 mm		
A-R19NERO-300-05	3000	hliník / hliník / alumínium / aluminiu	hliník / hliník / alumínium / aluminiu



Madlo COTE  
 Madlo COTE  
 Fogantyú profil COTE  
 Maner COTE

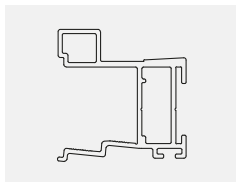

	 mm		
A-R18COTE-270-05	2700	hliník / hliník / alumínium / aluminiu	hliník, hliník, alumínium, aluminiu
A-R18COTE-270-90		šampaňské / šampanské / pezsgő / šampanie	



Madlo LOCA  
 Madlo LOCA  
 Fogantyú profil LOCA  
 Maner LOCA

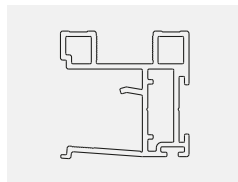

A-R18LOCA-305-05	3050	hliník / hliník / alumínium / aluminiu	hliník, hliník, alumínium, aluminiu
A-R18LOCA-305-90		šampaňské / šampaňské / pezsgő / şampanye	

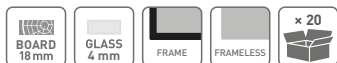

Madlo FLAT LINE  
 Madlo FLAT LINE  
 Fogantyú profil FLAT LINE  
 Maner FLAT LINE

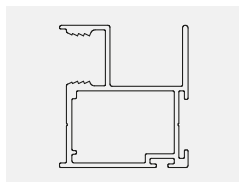

A-R10FL-270-05	2700	hliník / hliník / alumínium / aluminiu	hliník, hliník, alumínium, aluminiu
A-R10FL-270-10		bílá / biela / fehér / alb	
A-R10FL-270-20M		černá matná / čierna matná / matt fekete / negru mat	
A-R10FL-270-90		šampaňské / šampaňské / pezsgő / şampanye	



Madlo MOVENA  
 Madlo MOVENA  
 Fogantyú profil MOVENA  
 Maner MOVENA

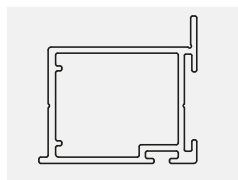

A-R4MQV-270-05	2700	hliník / hliník / alumínium / aluminiu	hliník, hliník, alumínium, aluminiu

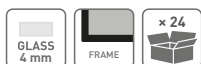

Madlo NOVO 10  
 Madlo NOVO 10  
 Fogantyú profil NOVO 10  
 Maner NOVO 10

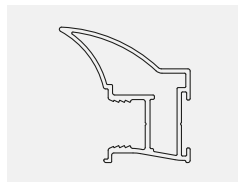

A-R10NOV-270-05	2700 mm	hliník / hliník / alumínium / aluminiu	hliník, hliník, alumínium, aluminiu
A-R10NOV-270-10		bílá / biela / fehé / alb	
A-R10NOV-270-20M		černá matná / čierna matná / matt fekete / negru mat	
A-R10NOV-270-90		šampaňské / šampanské / pezsgő / șampanie	



Madlo FORM  
 Madlo FORM  
 Fogantyú profil FORM  
 Maner FORM

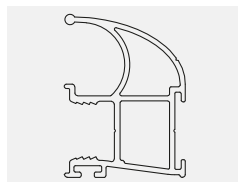

A-R10FORM-270-05	2700 mm	hliník / hliník / alumínium / aluminiu	hliník, hliník, alumínium, aluminiu
A-R10FORM-270-90		bílá / biela / fehé / alb	



Madlo TRAF0  
 Madlo TRAF0  
 Fogantyú profil TRAF0  
 Maner TRAF0



A-R10TRAF0-270-05	2700 mm	hliník / hliník / alumínium / aluminiu	hliník, hliník, alumínium, aluminiu
A-R10TRAF0-270-90		šampaňské / šampanské / pezsgő / șampanie	



Madlo TORO  
 Madlo TORO  
 Fogantyú profil TORO  
 Maner TORO

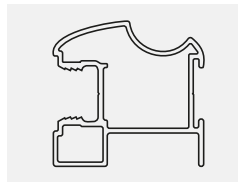







		 L mm		
A-R10TORO-270-05	2700	hliník / hliník / alumínium / aluminiu		hliník, hliník, alumínium, aluminiu
A-R10TORO-270-90*		šampaňské / šampanské / pezsgő / šampanie		

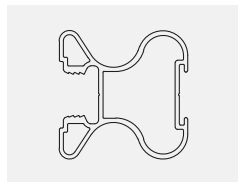

\*Do vyprodání zásob / Do vyprodania zásob / Amíg a készletek el nem fogynak / Până la epuizarea stocurilor

Madlo FALDA  
 Madlo FALDA  
 Fogantyú profil FALDA  
 Maner FALDA



		 L mm		
A-R10FALDA-270-05	2700	hliník / hliník / alumínium / aluminiu		hliník, hliník, alumínium, aluminiu
A-R10FALDA-270-90		šampaňské / šampanské / pezsgő / šampanie		
A-R10FALDA-270-20M		černá / čierna / fekete / negru		



Madlo ARCO\*  
 Madlo ARCO\*  
 Fogantyú profil ARCO\*  
 Maner ARCO\*

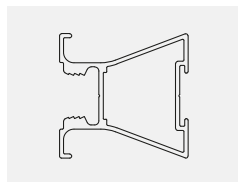







		 L mm		
A-R10ARCO-270-05	2700	hliník / hliník / alumínium / aluminiu		hliník, hliník, alumínium, aluminiu
A-R10ARCO-270-90		šampaňské / šampanské / pezsgő / šampanie		

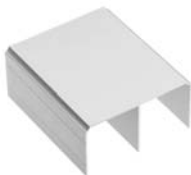

\*Do vyprodání zásob / Do vyprodania zásob / Amíg a készletek el nem fogynak / Până la epuizarea stocurilor

Horní kolejnice  
Horná koľajnica  
Felső vezető  
Sina superioara



	 L mm		
A-TG-170-05	1700	hliník / hliník / alumínium / aluminiu	
A-TG-170-10		bílá / biela / fehér / alb	
A-TG-170-20M		černá / čierna / fekete / negru	
A-TG-170-90		šampaňské / šampanské / pezsgő / șampanie	
A-TG-235-05	2350	hliník / hliník / alumínium / aluminiu	
A-TG-235-10		bílá / biela / fehér / alb	
A-TG-235-20M		černá / čierna / fekete / negru	
A-TG-235-90		šampaňské / šampanské / pezsgő / șampanie	
A-TG-300-05	3000	hliník / hliník / alumínium / aluminiu	
A-TG-300-10		bílá / biela / fehér / alb	
A-TG-300-20M		černá / čierna / fekete / negru	
A-TG-300-90		šampaňské / šampanské / pezsgő / șampanie	
A-TG-405-05	4050	hliník / hliník / alumínium / aluminiu	
A-TG-405-10		bílá / biela / fehér / alb	
A-TG-405-20M		černá / čierna / fekete / negru	
A-TG-405-90		šampaňské / šampanské / pezsgő / șampanie	
A-TG-600-05	6000	hliník / hliník / alumínium / aluminiu	
A-TG-600-10		bílá / biela / fehér / alb	
A-TG-600-20M		černá / čierna / fekete / negru	
A-TG-600-90		šampaňské / šampanské / pezsgő / șampanie	



Spodní kolejnice EVO  
 Spodná koľajnica EVO  
 Alsó vezetés EVO  
 Sina inferioara EVO



	 L mm		
A-TDEVO-170-05	1700	hliník / hliník / alumínium / aluminiu	hliník, hliník, alumínium, aluminiu
A-TDEVO-170-10		bílá / biela / fehér / alb	
A-TDEVO-170-20M		černá / čierna / fekete / negru	
A-TDEVO-170-90	šampaňské / šampanské / pezső / șampanie		
A-TDEVO-235-05	2350	hliník / hliník / alumínium / aluminiu	
A-TDEVO-235-10		bílá / biela / fehér / alb	
A-TDEVO-235-20M		černá / čierna / fekete / negru	
A-TDEVO-235-90	šampaňské / šampanské / pezső / șampanie		
A-TDEVO-300-05	3000	hliník / hliník / alumínium / aluminiu	
A-TDEVO-300-10		bílá / biela / fehér / alb	
A-TDEVO-300-20M		černá / čierna / fekete / negru	
A-TDEVO-300-90	šampaňské / šampanské / pezső / șampanie		
A-TDEVO-405-05	4050	hliník / hliník / alumínium / aluminiu	
A-TDEVO-405-10		bílá / biela / fehér / alb	
A-TDEVO-405-20M		černá / čierna / fekete / negru	
A-TDEVO-405-90	šampaňské / šampanské / pezső / șampanie		
A-TDEVO-600-05	6000	hliník / hliník / alumínium / aluminiu	
A-TDEVO-600-10		bílá / biela / fehér / alb	
A-TDEVO-600-20M		černá / čierna / fekete / negru	
A-TDEVO-600-90	šampaňské / šampanské / pezső / șampanie		



Maskovací kryt EVO  
 Maskovacia krytka EVO  
 Takaró profil EVO  
 Profil de mascare EVO







	 L mm		
A-MEVO-170-05	1700	hliník / hliník / alumínium / aluminiu	hliník, hliník, alumínium, aluminiu
A-MEVO-170-10A		bílá / biela / fehér / alb	
A-MEVO-170-20M		černá / čierna / fekete / negru	
A-MEVO-170-90	šampaňské / šampanské / pezső / șampanie		
A-MEVO-235-05	2350	hliník / hliník / alumínium / aluminiu	
A-MEVO-235-10A		bílá / biela / fehér / alb	
A-MEVO-235-20M		černá / čierna / fekete / negru	
A-MEVO-235-90	šampaňské / šampanské / pezső / șampanie		
A-MEVO-300-05	3000	hliník / hliník / alumínium / aluminiu	
A-MEVO-300-10A		bílá / biela / fehér / alb	
A-MEVO-300-20M		černá / čierna / fekete / negru	
A-MEVO-300-90	šampaňské / šampanské / pezső / șampanie		
A-MEVO-405-05	4050	hliník / hliník / alumínium / aluminiu	
A-MEVO-405-10		bílá / biela / fehér / alb	
A-MEVO-405-20M		černá / čierna / fekete / negru	
A-MEVO-405-90	šampaňské / šampanské / pezső / șampanie		





Spodní kolejnice EVO 2  
 Spodná koľajnica EVO2  
 Alsó vezető EVO 2  
 Sina inferioara EVO 2







			
A-TDEVO2-170-05	1700	hliník / hliník / alumínium / aluminiu	hliník, hliník, alumínium, aluminiu
A-TDEVO2-170-90*		šampaňské / šampanské / pezsgő / șampanie	
A-TDEVO2-235-05	2350	hliník / hliník / alumínium / aluminiu	
A-TDEVO2-235-90*		šampaňské / šampanské / pezsgő / șampanie	
A-TDEVO2-300-05	3000	hliník / hliník / alumínium / aluminiu	
A-TDEVO2-300-90*		šampaňské / šampanské / pezsgő / șampanie	
A-TDEVO2-405-05	4050	hliník / hliník / alumínium / aluminiu	
A-TDEVO2-405-90*		šampaňské / šampanské / pezsgő / șampanie	
A-TDEVO2-600-05	6000	hliník / hliník / alumínium / aluminiu	
A-TDEVO2-600-90*		šampaňské / šampanské / pezsgő / șampanie	



\*Do vyprodání zásob / Do vyprodania zásob / Amíg a készletek el nem fogytak / Până la epuizarea stocurilor

Spodní kolejnice PRO  
 Spodná koľajnica PRO  
 Alsó vezető PRO  
 Sina inferioara PRO



			
A-TDPRO-170-05	1700	hliník / hliník / alumínium / aluminiu	hliník, hliník, alumínium, aluminiu
A-TDPRO-170-10		bílá / biela / fehé / alb	
A-TDPRO-170-20M		černá / čierna / feket / negru	
A-TDPRO-170-90	2350	šampaňské / šampanské / pezsgő / șampanie	
A-TDPRO-235-05		hliník / hliník / alumínium / aluminiu	
A-TDPRO-235-10		bílá / biela / fehé / alb	
A-TDPRO-235-20M	3000	černá / čierna / feket / negru	
A-TDPRO-235-90		šampaňské / šampanské / pezsgő / șampanie	
A-TDPRO-300-05		hliník / hliník / alumínium / aluminiu	
A-TDPRO-300-10	4050	bílá / biela / fehé / alb	
A-TDPRO-300-20M		černá / čierna / feket / negru	
A-TDPRO-300-90		šampaňské / šampanské / pezsgő / șampanie	
A-TDPRO-405-05	6000	hliník / hliník / alumínium / aluminiu	
A-TDPRO-405-10		bílá / biela / fehé / alb	
A-TDPRO-405-20M		černá / čierna / feket / negru	
A-TDPRO-405-90	6000	šampaňské / šampanské / pezsgő / șampanie	
A-TDPRO-600-05		hliník / hliník / alumínium / aluminiu	
A-TDPRO-600-10		bílá / biela / fehé / alb	
A-TDPRO-600-20M	6000	černá / čierna / feket / negru	
A-TDPRO-600-90		šampaňské / šampanské / pezsgő / șampanie	



Maskovací kryt PRO  
 Maskovacia krytka PRO  
 Takaró profil PRO  
 Profil de mascare PRO



	 L mm		
A-MPRO-170-05	1700	hliník / hliník / alumínium / aluminiu	hliník, hliník, aluminium, aluminium
A-MPRO-170-10		bílá / biela / fehér / alb	
A-MPRO-170-20M		černá / čierna / fekete / negru	
A-MPRO-170-90		šampaňské / šampanské / pezsgő / šampanie	
A-MPRO-235-05	2350	hliník / hliník / alumínium / aluminiu	
A-MPRO-235-10		bílá / biela / fehér / alb	
A-MPRO-235-20M		černá / čierna / fekete / negru	
A-MPRO-235-90		šampaňské / šampanské / pezsgő / šampanie	
A-MPRO-300-05	3000	hliník / hliník / alumínium / aluminiu	
A-MPRO-300-10		bílá / biela / fehér / alb	
A-MPRO-300-20M		černá / čierna / fekete / negru	
A-MPRO-300-90		šampaňské / šampanské / pezsgő / šampanie	
A-MPRO-405-05	4050	hliník / hliník / alumínium / aluminiu	
A-MPRO-405-10		bílá / biela / fehér / alb	
A-MPRO-405-20M		černá / čierna / fekete / negru	
A-MPRO-405-90		šampaňské / šampanské / pezsgő / šampanie	



Horní lišta 18/4 mm  
 Horná lišta 18/4 mm  
 Felső sín 18/4 mm  
 Sina superioara 18/4 mm



	 L mm		
A-LG18-170-05*	1700	hliník / hliník / alumínium / aluminiu	hliník, hliník, aluminium, aluminium
A-LG18-170-90*		šampaňské / šampanské / pezsgő / šampanie	
A-LG18-235-05*	2350	hliník / hliník / alumínium / aluminiu	
A-LG18-235-90*		šampaňské / šampanské / pezsgő / šampanie	
A-LG18-300-05	3000	hliník / hliník / alumínium / aluminiu	
A-LG18-300-10		bílá / biela / fehér / alb	
A-LG18-300-20M		černá / čierna / fekete / negru	
A-LG18-300-90		šampaňské / šampanské / pezsgő / šampanie	
A-LG18-405-05*	4050	hliník / hliník / alumínium / aluminiu	
A-LG18-405-10*		bílá / biela / fehér / alb	
A-LG18-405-90*		šampaňské / šampanské / pezsgő / šampanie	
A-LG18-600-05*	6000	hliník / hliník / alumínium / aluminiu	
A-LG18-600-90*		šampaňské / šampanské / pezsgő / šampanie	



Spodní lišta 18/4 mm  
 Spodná lišta 18/4 mm  
 Alsó sín 18/4 mm  
 Sina inferioară 18/4 mm



			
A-LD18-170-05*	1700	hliník / hliník / alumínium / aluminiu	hliník, hliník, alumínium, aluminu
A-LD18-170-90*		šampaňské / šampanské / pezsgő / șampanie	
A-LD18-235-05*	2350	hliník / hliník / alumínium / aluminiu	
A-LD18-235-90*		šampaňské / šampanské / pezsgő / șampanie	
A-LD18-300-05	3000	hliník / hliník / alumínium / aluminiu	
A-LD18-300-10		bílá / biela / fehér / alb	
A-LD18-300-20M		černá / čierna / fekete / negru	
A-LD18-300-90		šampaňské / šampanské / pezsgő / șampanie	
A-LD18-405-05*	4050	hliník / hliník / alumínium / aluminiu	
A-LD18-405-10*		bílá / biela / fehér / alb	
A-LD18-405-90*		šampaňské / šampanské / pezsgő / șampanie	
A-LD18-600-05*	6000	hliník / hliník / alumínium / aluminiu	
A-LD18-600-90*		šampaňské / šampanské / pezsgő / șampanie	



\*Do vyprodání zásob / Do vyprodania zásob / Amíg a készletek el nem fogytak / Până la epuizarea stocurilor

Horní lišta 19 mm  
 Horná lišta 19 mm  
 Felső sín 19 mm  
 Sina superioara 19 mm

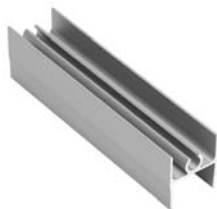

			
A-LG19-300-05	3000	hliník, hliník, alumínium, aluminu	hliník, hliník, alumínium, aluminu



Spodní lišta 19 mm  
 Spodná lišta 19 mm  
 Alsó sín 19 mm  
 Sina inferioară 19 mm





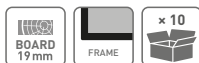

	 L mm		
A-LD19-300-05	3000	hliník, hliník, aluminium, aluminiiu	hliník, hliník, aluminium, aluminiiu



Horní lišta 10/4 mm  
 Horná lišta 10/4 mm  
 Felső sín 10/4 mm  
 Sina superioara 10/4 mm



	 L mm		
A-LG10-170-05*	1700	hliník / hliník / aluminium / aluminiiu	hliník, hliník, aluminium, aluminiiu
A-LG10-235-05*	2350	hliník / hliník / aluminium / aluminiiu	
A-LG10-235-90*		šampaňské / šampanské / pezsgó / şampanie	
A-LG10-300-05	3000	hliník / hliník / aluminium / aluminiiu	
A-LG10-300-10		bílá / biela / fehér / alb	
A-LG10-300-20M		černá matná / čierna matná / matt fekete / negru mat	
A-LG10-300-90		šampaňské / šampanské / pezsgó / şampanie	
A-LG10-405-05*	4050	hliník / hliník / aluminium / aluminiiu	
A-LG10-405-90*		šampaňské / šampanské / pezsgó / şampanie	
A-LG10-600-05*	6000	hliník / hliník / aluminium / aluminiiu	
A-LG10-600-90*		šampaňské / šampanské / pezsgó / şampanie	



\*Do vyprodání zásob / Do vyprodania zásob / Amíg a készletek el nem fogynak / Până la epuizarea stocurilor

Spodní lišta 10/4 mm  
 Spodná lišta 10/4 mm  
 Alsó sín 10/4 mm  
 Sina inferioară 10/4 mm



	 L mm		
A-LD10-170-05*	1700	hliník / hliník / alumínium / aluminiu	hliník, hliník, alumínium, aluminu
A-LD10-235-05*	2350	hliník / hliník / alumínium / aluminiu	
A-LD10-235-90*		šampaňské / šampanské / pezsgő / șampanie	
A-LD10-300-05	3000	hliník / hliník / alumínium / aluminiu	
A-LD10-300-10		bílá / biela / fehér / alb	
A-LD10-300-20M		černá matná / čierna matná / matt fekete / negru mat	
A-LD10-300-90		šampaňské / šampanské / pezsgő / șampanie	
A-LD10-405-05*	4050	hliník / hliník / alumínium / aluminiu	
A-LD10-405-90*		šampaňské / šampanské / pezsgő / șampanie	
A-LD10-600-05*	6000	hliník / hliník / alumínium / aluminiu	
A-LD10-600-90*		šampaňské / šampanské / pezsgő / șampanie	



\*Do vyprodání zásob / Do vypredania zásob / Amíg a készletek el nem fogynak / Până la epuizarea stocurilor

Horní lišta 4 mm  
 Horná lišta 4 mm  
 Felső sín 4 mm  
 Sina superioara 4 mm



	 L mm		
A-LG4MOV-300-05	3000	hliník / hliník / alumínium / aluminiu	hliník, hliník, alumínium, aluminu

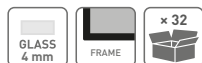

Spodní lišta 4 mm  
 Spodná lišta 4 mm  
 Alsó sín 4 mm  
 Sina inferioară 4 mm





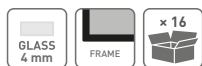

	 L mm		
A-LD4MOV-300-05	3000	hliník / hliník / aluminium / aluminiu	hliník, hliník, aluminium, aluminiu



Horní lišta FL 10/4 mm  
 Horná lišta FL 10/4 mm  
 Felső sín FL 10/4 mm  
 Sina superioara FL 10/4 mm



	 L mm		
A-LG10FL-300-05	3000	hliník / hliník / aluminium / aluminiu	hliník, hliník, aluminium, aluminiu
A-LG10FL-300-10		bílá / biela / fehér / atb	
A-LG10FL-300-20M		černá matná / čierna matná / matt fekete / negru mat	
A-LG10FL-300-90		šampaňské / šampanské / pezsgő / şampanie	



Spodní lišta FL 10/4 mm  
 Spodná lišta FL 10/4 mm  
 Alsó sín FL 10/4 mm  
 Sina inferioară FL 10/4 mm



	 L mm		
A-LD10FL-300-05	3000	hliník / hliník / alumínium / aluminiu	hliník, hliník, alumínium, aluminii
A-LD10FL-300-10		bílá / biela / fehé / alb	
A-LD10FL-300-20M		černá matná / čierna matná / matt fekete / negru mat	
A-LD10FL-300-90		šampaňské / šampanské / pezsgő / șampanie	



Úhelníkový profil  
 Uhlavá lišta  
 Szögletes takaró profil  
 Profil de colt





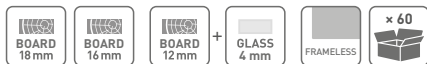

	 L mm		
A-K18-300-05	3000	hliník / hliník / alumínium / aluminiu	hliník, hliník, alumínium, aluminii
A-K18-300-10		bílá / biela / fehé / alb	
A-K18-300-20M		černá / čierna / fekete / negru	
A-K18-300-90		šampaňské / šampanské / pezsgő / șampanie	



Profil C18  
 Profil C18  
 C18 profil  
 Profil C18





	 L mm		
A-C18-300-S-05	3000	hliník / hliník / alumínium / aluminiu	hliník, hliník, alumínium, aluminiu
A-C18-300-S-10		bílá / biela / fehér / alb	
A-C18-300-S-20M		černá matná / čierna matná / matt fekete / negru mat	
A-C18-300-S-90		šampaňské / šampanské / pezsgő / șampanie	



Profil T18  
 Profil T18  
 T18 profil  
 Profil T18



	 L mm		
A-T18-300-05	3000	hliník / hliník / alumínium / aluminiu	hliník, hliník, alumínium, aluminiu
A-T18-300-10		bílá / biela / fehér / alb	
A-T18-300-90		šampaňské / šampanské / pezsgő / șampanie	
A-T18-300-20M		černá / čierna / fekete / negru	



Profil H16  
 Profil H16  
 H16 profil  
 Profil H16



	 L mm		
A-H16-300-05	3000	hliník / hliník / alumínium / aluminiu	hliník, hliník, alumínium, aluminiu
A-H16-300-90*		šampaňské / šampanské / pezsgő / șampanie	







\*Do vyprodání zásob / Do vyprodania zásob / Amíg a készletek el nem fogytak / Până la epuizarea stocurilor





Profil H18  
 Profil H18  
 H18 profil  
 Profil H18



	 L mm		
A-H18-300-05	3000	hliník / hliník / aluminium / aluminiu	hliník, hliník, aluminium, aluminiiu
A-H18-300-10*		bílá / biela / fehér / alb	
A-H18-300-20M		černá / čierna / fekete / negru	
A-H18-300-90		šampaňské / šampanské / pezsgő / şampanie	



Profil H18 RA  
 Profil H18 RA  
 H18 RA profil  
 Profil H18 RA



	 L mm		
A-HR18-300-05RA	3000	hliník / hliník / aluminium / aluminiu	hliník, hliník, aluminium, aluminiiu
A-HR18-300-90RA		šampaňské / šampanské / pezsgő / şampanie	



Profil HR18  
 Profil HR18  
 HR18 profil  
 Profil HR18



	 L mm		
A-HR18-300-05	3000	hliník / hliník / alumínium / aluminiu	hliník, hliník, alumínium, aluminiu
A-HR18-300-10		bílá / biela / fehér / alb	
A-HR18-300-20M		černá / čierna / fekete / negru	
A-HR18-300-90		šampaňské / šampanské / pezsgő / șampanie	



Profil HRS18  
 Profil HRS18  
 HRS18 profil  
 Profil HRS18



	 L mm		
A-HRS18-170-05*	1700	hliník / hliník / alumínium / aluminiu	hliník, hliník, alumínium, aluminiu
A-HRS18-170-90*		šampaňské / šampanské / pezsgő / șampanie	
A-HRS18-235-05*	2350	hliník / hliník / alumínium / aluminiu	
A-HRS18-235-90*		šampaňské / šampanské / pezsgő / șampanie	
A-HRS18-300-05	3000	hliník / hliník / alumínium / aluminiu	
A-HRS18-300-90		šampaňské / šampanské / pezsgő / șampanie	
A-HRS18-405-05*	4050	hliník / hliník / alumínium / aluminiu	
A-HRS18-405-90*		šampaňské / šampanské / pezsgő / șampanie	
A-HRS18-600-05*	6000	hliník / hliník / alumínium / aluminiu	
A-HRS18-600-90*		šampaňské / šampanské / pezsgő / șampanie	



\*Do vyprodání zásob / Do vypredania zásob / Amíg a készletek el nem fogynak / Până la epuizarea stocurilor





Profil HR19  
 Profil HR19  
 HR19 profil  
 Profil HR19

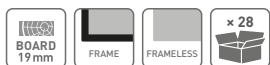

	 L mm		
A-HR19-300-05	3000	hliník / hliník / alumínium / aluminiu	hliník / hliník / alumínium / aluminiu

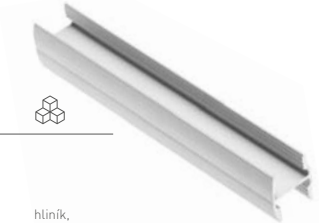

Profil HR10  
 Profil HR10  
 HR10 profil  
 Profil HR10

			
A-HR10-235-05*	2350	hliník / hliník / alumínium / aluminiu	
A-HR10-235-90*		šampaňské / šampanské / pezsgő / șampanie	
A-HR10-300-05	3000	hliník / hliník / alumínium / aluminiu	
A-HR10-300-10		bílá / biela / fehéř / alb	
A-HR10-300-90		šampaňské / šampanské / pezsgő / șampanie	
A-HR10-405-05*	4500	hliník / hliník / alumínium / aluminiu	
A-HR10-405-90*		šampaňské / šampanské / pezsgő / șampanie	
A-HR10-600-05*	6000	hliník / hliník / alumínium / aluminiu	
A-HR10-600-90*		šampaňské / šampanské / pezsgő / șampanie	



\*Do vyprodání zásob / Do vyprodania zásob / Amíg a készletek el nem fogynak / Până la epuizarea stocurilor



 Profil HRS10  
 Profil HRS10  
 HRS10 profil  
 Profil HRS10

			
A-HRS10-170-05*	1700	hliník / hliník / alumínium / aluminiu	
A-HRS10-300-05	3000	šampaňské / šampanské / pezsgő / șampanie	
A-HRS10-300-90		hliník / hliník / alumínium / aluminiu	
A-HRS10-405-05*	4050		
A-HRS10-600-05*	6000		



\*Do vyprodání zásob / Do vyprodania zásob / Amíg a készletek el nem fogynak / Până la epuizarea stocurilor



 Profil HR10 FL  
 Profil HR10 FL  
 HR10 FL profil  
 Profil HR10 FL

			
A-HR10FL-300-05	3000	hliník / hliník / alumínium / aluminiu	
A-HR10FL-300-10		bílá / biela / fehéř / alb	
A-HR10FL-300-20M		černá matná / čierna matná / matt fekete / negru mat	
A-HR10FL-300-90		šampaňské / šampanské / pezsgő / șampanie	



Horní kolečka PG-18  
 Horné kolieska PG-18  
 Felső görgő PG-18  
 Rola culisare superioară PG-18





		
A-PG-18	50	ocel, plast, ocel, plast, acél, műanyag, oțel, plastic



Horní kolečka PGR-18  
 Horné kolieska PGR-18, rám  
 Felső görgő PGR-18  
 Rola culisare superioară PGR-18





		
A-PGR-18	50	ocel, plast, ocel, plast, acél, műanyag, oțel, plastic



Horní kolečka PGR-10  
 Horné kolieska PGR-10  
 Felső görgő PGR-10  
 Rola culisare superioară PGR-10





		
A-PGR-10	50	ocel, plast, ocel, plast, acél, műanyag, oțel, plastic



Horní kolečka PGR-10, symetrická  
 Horné kolieska PGR-10, symetrické  
 Szimmetrikus felső görgő PGR-10  
 Rola culisare superioară PGR-10





		
A-PGR-10S	50	ocel, plast, ocel, plast, acél, műanyag, oțel, plastic



Distanční destička  
 Dištančná doštička  
 Távolság tartó lemez  
 Placă distanțieră





		
A-DPG-16	50	ocel, ocel, acél, oțel



Spodní jezdec EVO2  
 Spodné kolieska EVO 2  
 Alsó görgő EVO 2  
 Rola culisare inferioară EVO 2





		
A-WD-EVO2	50	ocel, plast, ocel, plast, acél, műanyag, oțel, plastic



Vedení k EVO 2  
 Vedenie k EVO 2  
 Vezetőtartó EVO 2  
 Ghid EVO 2





		
A-ZAC-WDEVO2	50	ocel, plast, ocel, plast, acél, műanyag, oțel, plastic



Spodní jezdec PRO  
 Spodné kolieska PRO  
 Alsó görgő PRO  
 Rola culisare inferioară PRO





		
A-WD-PRO	50	ocel, plast, ocel, plast, acél, műanyag, oțel, plastic



Spodní jezdec EVO  
 Spodné kolieska EVO, rám  
 Alsó keretes görgő EVO  
 Rolă inferioară EVO





		
A-WDR-EVO	50	ocel, plast, ocel, plast, acél, műanyag, oțel, plastic



Spodní jezdec PRO  
 Spodné kolieska PRO, rám  
 Alsó keretes görgő PRO  
 Rolă inferioară PRO





		
A-WDR-PRO	50	ocel, plast, ocel, plast, acél, műanyag, otel, plastic



Horní pozicionér  
 Horný pozicionér  
 Felső pozicionáló  
 Oprior culisare superioara





		
A-PTG	50	plast, plast, műanyag, plastic



Spodní pozicionér PRO  
 Spodný pozicionér PRO  
 Alsó pozicionáló PRO  
 Oprior culisare inferioara PRO





		
A-PTD	50	ocel, ocel, acél, otel



Dorazový kartáček 4,8 x 4 mm  
 Štetina dorazová. 4,8 x 4  
 Tolóajtó porkefe 4,8 x 4  
 Perie 4,8 x 4





		
A-SO-R-48X4	šedá / sivá / szürke / gri	plast, plast, műanyag, plastic
A-SO-R-48X4-20	černá / čierna / fekete / negru	



Dorazový kartáček široký, 14,5 x 4 mm  
 Štetina dorazová, široká, 14,5 x 4  
 Tolóajtó porkefe széles, 14,5 x 4  
 Perie largă 14,5 x 4



		
A-SO-R-145X4	šedá / sivá / szürke / gri	plast, plast, műanyag, plastic
A-SO-R-145X4-10	bílá / biela / fehér / alb	
A-SO-R-145X4-20	černá / čierna / fekete / negru	



Protiprachový kartáček 4,8 x 7 mm - bez lepidla  
 Štetina protiprachová, nasúvacía 4,8 x 7  
 Tolóajtó porkefe ragasztó nélkül 4,8 x 7  
 Perie antipraf fără lipici 4,8 x 7



		
A-SP-R-48X7	šedá, sivá, szürke, gri	plast, plast, műanyag, plastic





Protiprachový kartáček 7 x 12 mm s lepidlem  
 Štetina protiprachová, nalepovacia 7 x 12  
 Tolóajtó porkefe ragasztóval 7 x 12  
 Perie antipraf cu lipici 7 x 12



		
A-SP-R-7X12	šedá, sivá, szürke, gri	plast, plast, műanyag, plastic



Protiprachový kartáček 4,8 x 12 mm - bez lepidla  
 Štetina protiprachová, nasúvacia 4,8 x 12  
 Tolóajtó porkefe ragasztó nélkül 4,8 x 12  
 Perie antipraf fără lipici 4,8 x 12



		
A-SP-R-48X12	šedá, sivá, szürke, gri	plast, plast, műanyag, plastic



Klín do madla  
 Klín do bočného profilu  
 Ék fogantyúhoz  
 Pană pentru profil mâner



		
A-KR-4	bílá / biela / fehér / alb	plast, plast, műanyag, plastic
A-KR-4-20	černá / čierna / fekete / negru	



Klín do vodících profilů  
 Klín do spojovacieho profilu  
 Ék vízszintes csíkokhoz  
 Pană pentru profil orizontal



		
A-KLP-4	bílá / biela / fehér / alb	plast, plast, műanyag, plastic
A-KLP-4-20	černá / čierna / fekete / negru	



Epeňovací element spodního vedení EVO 2  
 Upevňovacia spona pre spodnú koľaj EVO 2  
 Szerelőkapocs az EVO 2 alsó vezetőkhöz  
 Clemă de montare pentru sina inferioară EVO 2



		
A-ZAT-TDEV02	smetanová smotanová tej lapte	plast, plast, műanyag, plastic



Těsnění U, středně tvrdé  
 Tesnenie U, stredne tvrdé  
 U ajtóközti tömítés, közepesen kemény  
 Garnitura U, dură medie







			
A-USZCZ-U4	100	průhledný priehľadná átlátszó transparent	plast, plast, műanyag, plastic



Těsnění typu CH, měkké  
 Tesnenie typu CH, mäkké  
 CH típusú tömítés, puha  
 Garnitura tip CH, moale







	 L m		
A-USZCZ-CHM4	120	průhledný / priehľadná / átlátszó / transparent	plast, plast, műanyag, plastic
A-USZCZ-CHM4-20	150	černá / čierna / fekete / negro	



Těsnění pro kolejnici EVO 2  
 Tesnenie pre koľajnicu EVO 2  
 Ajtóközti tömítés az EVO 2 vezetékhez  
 Garnitură pentru sina EVO 2



	 L m		
A-USZCZ-TDEV02	200	smetanová smotanová tej lapte	PVC



Ocelový šroub 6,3 x 40  
 Oceľová skrutka 6,3 x 40  
 Acél fémcsavar 6,3 x 40  
 Şurub fixare 6,3 x 40



	
A-B63-40	ocel, oceľ, acél, oțel



Ocelový šroub 6,3 x 32  
 Ocelová skrutka 6,3 x 32  
 Acél fémcsvavar 6,3 x 32  
 Şurub fixare 6,3 x 32





	
A-B63-32*	ocel, oceř, acél, oțel



\*Do vyprodání zásob / Do vyprodania zásob / Amíg a készletek el nem fogynak / Până la epuizarea stocurilor

Tlumič dorazu SIMON  
 Tlmenie SIMON  
 Tolóajtóhoz csillapító SIMON  
 Amortizor SIMON



		
A-SOFT-30*	30	ocel, plast, ocel, plast, acél, műanyag, oțel, plastic
A-SOFT-50*	50	



\*Do vyprodání zásob / Do vyprodania zásob / Amíg a készletek el nem fogynak / Până la epuizarea stocurilor



Tlumič dorazu SIMON  
 Tlmenie SIMON, obojstranné  
 Tolóajtóhoz csillapító SIMON  
 Amortizor SIMON



		
A-MSOFT-RAMA*	50	ocel, plast, ocel, plast, acél, műanyag, oțel, plastic



\*Do vyprodání zásob / Do vyprodania zásob / Amíg a készletek el nem fogynak / Până la epuizarea stocurilor





Tlumič dorazu ZIMMER  
 Tlmenie ZIMMER  
 Tolóajtóhoz csillapító ZIMMER  
 Amortizor ZIMMER

		
A-SOFT-30Z	30	ocel, plast, ocel, plast, acél, műanyag, oțel, plastic
A-SOFT-50Z	50	



Adaptér k tlumiči SIMON  
 Adaptér pre obojstranné tlenie  
 Tolóajtó csillapítóhoz adapter  
 Adaptor pentru amortizor



		
A-MSOFT-ADAPT	50	ocel, oceř, acél, oțel



Zámek pro systémy posuvných dveří  
 Zámok pre posuvné dvere  
 Zár a tolóajtó rendszerekhez  
 Încuietoare pentru sisteme de uși culisante



	
ZZ-SP-105-05	ocel, plast, ocel, plast, acél, műanyag, oțel, plastic







Zámek pro systémy posuvných dveří  
 Šablóna na predvrtávanie s dořahom  
 Előfűró sablon meghúzással  
 Sablon pentru ore-gaurire



	
A-PW-RC-DOC	ocel, oceř, acél, oțel



MITO  
MITO  
MITO  
MITO

 <p>Kolejnice MITO Lišta MITO Sín MITO Sina MITO</p>	A-TMITO-200-00	200	50	surový hliník surový hliník nyers aluminium aluminium brut	hliník, hliník, aluminium, aluminium	56
	A-TMITO-250-00	250				
	A-TMITO-300-00	300				
	A-TMITO-200-05	200				
	A-TMITO-250-05	250				
	A-TMITO-300-05	300				
 <p>Pozicionér Polohovadlo Pozicionáló Poziționer</p>	A-POZ-MITO	-	šedá, sivá, szürke, gri	plast, plast, műanyag, plastic	2000	
 <p>Horní vedení Horné vedenie Felső vezetőtartó Sina ghidare superioara</p>	A-SG-MITO	-	pozinkovaný pozinkovaný galvanizált galvanizat	ocel, plast, ocel, plast, acél, műanyag, oțel, plastic	400	
 <p>Spodní váleček s kuličkovým ložiskem Spodný valček s guľočkovým ložiskom Alsó görgő golyóscsapágy Rola inferioara cu bile</p>	A-RD-MITO	-				

 Sada MITO PLUS  
Sada MITO PLUS  
MITO PLUS szett  
Set MITO PLUS

2 horní válečky s pružinou, 2 spodní válečky s kuličkovými ložisky, 1 polohovadlo, sada šroubů  
2 horné valčeky s pružinou, 2 spodné valčeky s guľočkovými ložiskami, 1 polohovadlo, súprava skrutiek  
2 felső görgő rugóval, 2 alsó golyóscsapágy görgő, 1 pozicionáló, csavar készlet  
2 role superioare cu arc, 2 role inferioare cu bile, 1 poziționator, set de șuruburi



A-MITO-PLUS	50	pozinkovaný / pozinkovaný / galvanizált / galvanizat	ocel / ocel / acél / oțel
-------------	----	---	---------------------------



Sada OVERLINE  
 Sada OVERLINE  
 OVERLINE szett  
 Set OVERLINE

2 vnější válečky, 2 vnitřní válečky, 2 polohovadla, 2 spodní vedení pro vnější dvířka, 2 spodní vedení vnitřních dvířek  
 2 vonkajšie valčeky, 2 vnútorné valčeky, 2 polohovadlá, 2 spodné vedenia pre vonkajšie dvierka, 2 spodné vedenia vnútorných dvierok  
 2 külső görgő, 2 belső görgő, 2 pozícionáló, 2 alsó vezeték a külső ajtóhoz, 2 alsó vezeték a belső ajtóhoz  
 2 role exterioare, 2 role interne, 2 poziționatoare, 2 sine inferioare pentru ușa exterioară, 2 sine inferioare ale ușii interne

A-SN-FSET	50	pozinkovaný / pozinkovaný / galvanizált / galvanizat	ocel, plast ocel, plast / acél, műanyag / oțel, plastic	10		
	Madlo RIVA Madlo RIVA Fogantyú profil RIVA Maner RIVA	A-SN-R19RIV-270-05*	-		24	
	Profil C19 Profil C19 C19 profil Profil C19	A-SN-K19-270-05*	-	hliník, hliník, aluminium, aluminu	hliník, hliník, aluminium, aluminu	
	Profil C18 Profil C18 C18 profil Profil C18	A-C18-300-S-05	3000	-	50	
	Horní kolejnice Horná kotajnica Felső vezetés Sina superioara	A-SN-TG-405-00	4050	50	surový hliník surový hliník nyers aluminium aluminu brut	ocel, ocel, acél, oțel
	Spodní kolej Spodná kotajnica Alsó vezetés Sina inferioara	A-SN-TDS-405-00			hliník, hliník, aluminium, aluminu	40
	Tlumič s pomalým zavíráním Tíműs s pomalým zatváraním Fékes lengéscsillapító Amortizor	A-SN-SOFT-25Z	-	25	šedá, sivá, szürke, gri	plast, plast, műanyag, plastic
		A-SN-SOFT-40Z	-	40		
	Sada tlumiče s pomalým zavíráním Súprava tlumiča s pomalým zatváraním Fékes lengéscsillapító készlet Set amortizor 1 ks aktivátoru na vnější dvířka a 1 ks na vnitřní dvířka, 4 ks adaptér, 1 sada šroubů 1 ks aktivátora na vonkajšie dvierka a 1 ks na vnútorné dvierka, 4 ks adaptér, 1 súprava skrutiek 1 db aktivátor külső ajtó és 1 db belső ajtó, 4 db adapter, 1 csavar készlet 1 buc activator ușă exterioară si 1 buc ușă interioară, adaptor 4 bucăți, 1 set de șuruburi	A-SN-ADSET	-	-	-	ocel, plast, ocel, plast, acél, műanyag, oțel, plastic

Sada OVERLINE PLUS  
Sada OVERLINE PLUS  
OVERLINE PLUS szett  
Set OVERLINE PLUS



2 vnější válečky, 2 vnitřní válečky, 2 spodní vedení pro vnější dvířka, 2 spodní vedení pro vnitřní dvířka, šrouby  
2 vonkajšie valčeky, 2 vnútorné valčeky, 2 spodné vedenia pre vonkajšie dverka, 2 spodné vedenia pre vnútorné dverka, skrutky  
2 külső görgő, 2 belső görgő, 2 alsó sín a külső ajtóhoz, 2 alsó sín a belső ajtóhoz, csavarok  
2 role exterioare, 2 role interne, 2 sine inferioare pentru ușa exterioară, 2 sine inferioare pentru ușa internă, șuruburi

A-SN-HSET1	50	pozinkovaný / pozinkovaný / galvanizált / galvanizat	ocel, plast ocel, plast / acél, műanyag / oțel, plastic	1	
	Madlo RIVA Madlo RIVA Fogantyú profil RIVA Maner RIVA	A-SN-R19RIV-270-05*	2700	-	24
	Profil C19 Profil C19 C19 profil Profil C19	A-SN-K19-270-05*		-	48
	Profil C18 Profil C18 C18 profil Profil C18	A-C18-300-S-05	3000	-	50
	Horná kolej Horná kotajnica Felső vezetős Sina superioara	A-SN-TG-405-00	4050	-	80
	Spodní kolej Spodní kotajnica Alsó vezetős Sina inferoara	A-SN-TDT-405-00		-	20
	Tlumič s pomalým zavíráním Tlmič s pomalým zatváraním Fékes lengéscsillapító Amortizor	A-SN-SOFT-25Z	-	25	-
		A-SN-SOFT-40Z	-	40	-
	Polohovadlo Polohovadlo Pozicionáló Pozitioner	A-SN-POZ	-	-	20
	Sada tlumiče s pomalým zavíráním Súprava tlmiča s pomalým zatváraním Fékes lengéscsillapító készlet Set amortizor 1 ks aktivátoru na vnější dvířka a 1 ks na vnitřní dvířka, 4 ks adaptér, 1 sada šroubů 1 ks aktivátoru na vonkajšie dverka a 1 ks na vnútorné dverka, 4 ks adaptér, 1 súprava skrutiek 1 db aktivátor külső ajtó és 1 db belső ajtó, 4 db adapter, 1 csavar készlet 1 buc activator ușa exterioară și 1 buc ușa interioară, adaptor 4 bucăți, 1 set de șuruburi	A-SN-ADSET	-	-	100

\*Do vyprodání zásob / Do vyprodania zásob / Amíg a készletek el nem fogynak / Până la epuizarea stocurilor



Dveřní výztuha na srovnání dveří  
Sada pre vyrovnávanie dverí  
Ajtó egyenirányító megvetemedett  
Rectificator ușă deformat



Utahovací lišta - 2 ks, napínací deska - 2 ks, přítláčná deska - 4 ks, krycí uzávěr, potahovací pouzdro, nastavovací klíč  
Sťahovacia lišta - 2ks, nťahovacia platnička - 2ks, prítláčna platnička - 4ks, krytka, nastavovacia matica, kľúč pre nastavienie  
Szorító szalag - 2 db, feszítőlemez - 2 db, nyomólemez - 4 db, takarósapka, pozícionáló hüvely, beállító kulcs  
Bandă de strângere - 2 buc, placă de tensionare - 2 buc, placă de presiune - 4 buc, capac de acoperire, manșon de poziționare, cheie de reglare



A-SN-SDP-TU

50

pozinkovaný / pozinkovaný /  
galvanizált / galvanizat

ocel, plast ocel, plast / acél, műanyag / oțel, plastic



Sada QUANTUM  
Sada QUANTUM  
QUANTUM szett  
Set QUANTUM



Válečky - 2 ks, zárážky - 2 ks, vodičko - 2 ks, sada šroubů  
Horné kolieska - 2 ks, zárážky - 2 ks, vedenie - 2 ks, sada skrutiek  
Görgők - 2 db, fék - 2 db, vezetőtartó - 2 db, csavaros készlet  
Role - 2 buc, dopuri - 2 buc, ghidaj - 2 buc, set de șuruburi

A-BUDP-SET	50	hliník / hliník / aluminium / aluminium	ocel, plast ocel, plast / acél, műanyag / oțel, plastic	24

	 mm						
<p>Horná kolej Horná vodiaca lišta Felső vezetés Sina superioara</p>	A-TG-BUD-200-00	2000	50	surový hliník surový hliník nyers aluminium aluminium brut	hliník, hliník, aluminium, aluminium	+	15
	A-TG-BUD-300-00	3000					
<p>Boční příchytky Bočná príchytka Oldalsó tartó Support lateral</p>	A-BUD-K-UB*	-	50	pozinkovaný pozinkovaný galvanizált galvanizát	ocel, ocel, acél, oțel	+	50
<p>Horní držák kolejnice Vrchný držiak Top tartó Support superior</p>	A-BUD-K-UB*	-					
<p>Přichytka maskovacího krytu horní lišty Príchytka maskovacieho krytu hornej lišty A felső sín takarófedél tartója Suportul capacului de mascare a șinei superioare</p>	A-BUD-UM	60	50	hliník, hliník, aluminium, aluminium	hliník, hliník, aluminium, aluminium	-	250
<p>Přichytka rámu (4 ks) Príchytka rámu (4 ks) Keret tartó (4 db) Suport cadru (4 buc)</p>	A-BUD-UR	-					
<p>Přichytka desky Príchytka desky Bütörlap tartó Support blat</p>	A-BUD-UP	-	50	pozinkovaný pozinkovaný galvanizált galvanizát	ocel, ocel, acél, oțel	+	50 set

\*1 sada = 50 ks / 1 súprava = 50 ks / 1 készlet = 50 db / 1 set = 50 buc

Sada LOFT  
Sada LOFT  
LOFT szett  
Set LOFT



Váleček - 2 ks, posuv - 1 ks, lišta 2 m, distanční pouzdro - 5 ks, tlumič 2 ks, zarážka zabraňující vypadnutí dveří - 2 ks, tlumič s pomalým zavíráním - 2 ks, aktivátor - 2 ks, sada šroubů

Válček - 2 ks, výsuv - 1 ks, lišta 2 m, distančné pouzdro - 5 ks, tlmič 2 ks, doraz zabraňující vypadnutiu dverí - 2 ks, tlmič s pomalým zatváraním - 2 ks, aktivátor - 2 ks, súprava skrutiek

Görgő - 2 db, csúszo - 1 db, vágány 2 m, távhüvely - 5 db, lökhárító 2 db, dugó megakadályozza az ajtó kitérését - 2 db, lágy záró csappantyú - 2 db, érintkező - 2 db, csavaros készlet

Role - 2 buc, glisieră - 1 buc, șină 2 m, manșon de distanță - 5 buc, bara de protecție 2 buc, dop care împiedică căderea ușii - 2 buc, amortizor de închidere moale - 2 buc, element de contact - 2 buc, set de șuruburi



A-SN-LOFT-200-20M

100

černá / čierna / fekete / negro

ocel, plast ocel, plast / acél, műanyag / oțel, plastic

1



Poručená rukovet v loftovém stylu - UZ-STEP-160-20M

Odporúčaný úchyt v loftovom štýle - UZ-STEP-160-20M

Ajánlott loft stílusú fogantyú - UZ-STEP-160-20M

Mâner în stil loft recomandat - UZ-STEP-160-20M



## OSVĚTLENÍ NÁBYTKU OSVETLENIE NÁBYTKU BÚTORVILÁGÍTÁS ILUMINAT MOBILIER

LED pásky LED pásiky LED szalagok Benzi LED	550 – 555
LED profily LED profily LED profilok Profiluri LED	556 – 587
LED svítidla LED svidtlá LED szerelvények Spoturi LED	588 – 595
Příslušenství Doplnky Kiegészítők Accesorii	596 – 625
Zásuvky na stoly Zásuvky na stoly Asztali csatlakozók Prize de birou	626 – 647







## Sestavení sady EASY CLICK v 5 krocích Zostavenie súpravy EASY CLICK v 5 krokoch Töltse ki az EASY CLICK készletet 5 lépésben Completați setul EASY CLICK în 5 pași



1.

vyberte LED pásek  
vyberte LED pásik  
válasszon egy szalagot  
selectați o bandă

vyberte počet částí LED pásků  
vyberte počet částí LED pásků  
válassza ki a LED-szalagok szakaszainak számát  
selectați numărul de secțiuni ale benzilor LED

2.

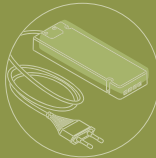

3.

odpovídající napájecí zdroj  
vhodný napájecí zdroj  
illesztett tápegység  
sursă de alimentare potrivită

vyberte si svůj profil: profily se prodávají jako kompletní  
2m sady, včetně profilu, krytu a 2 koncovek.

vyberte si profil: profily sa predávajú ako kompletné 2 m  
sady vrátane profilu, krytu a 2 koncoviek

válasszon egy profilt a profilok kész 2 m-es készletként  
kerülnek értékesítésre, tartalmaz egy profilt,  
fedelelet és 2 dugót

selectați un profil profilele sunt vândute ca seturi  
de 2 m, inclusiv un profil, capac și 2 mufe

4.

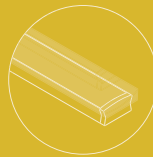

5.

vyberte si vypínač  
vyberte si vypínač  
válasszon egy kapcsolót  
selectați un comutator

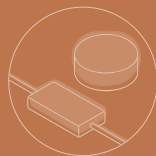

před montáží  
pred montážou  
összehajtás előtt  
înainte de pliere

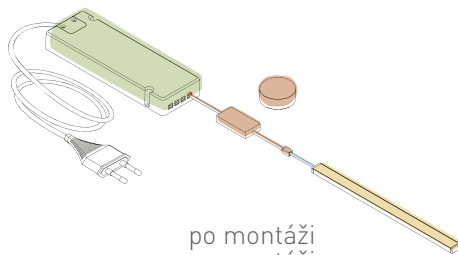

po montáži  
po montážii  
hajtogatás után  
după pliere

Vzorové schéma pro instalaci  
Vzorová schéma inștalácie  
Minta telepítési diagram  
Exemplu de instalare

LED pásek v profilu  
LED pásik v profile  
LED szallag profilban  
Banda LED într-un profil

Kábel od vypínače k LED pásku  
kábel od LED pásu k vypínaču  
kábel a LED szalagtól a kapcsológ  
cablu de la banda LED la comutator

napájecí kabely  
káble spínača  
kapcsoló vezetékek  
firele comutatorului

kábel ze síťové zásuvky 230 V  
do LED ovládače  
kábel zo sieťovej zásuvky  
230 V k LED ovládaču  
kábel a 230 V-os aljzatból  
a tápegységbe  
cablu de la priza de 230 V  
la sursa de alimentare

spínač  
spínač  
kapcsoló  
intrerupator

napájecí zdroj  
LED ovládač  
Tápegység  
Alimentare electrică

LED pásek FLASH (s blikáním)  
LED pásik FLASH  
FLASH LED szalag  
Bandă LED FLASH



LD-3528-300-20-ZB	12 VDC 4,8 W/1 m 17 W/5 m	300 lm/m		6500 K	20	120°	60/m	5	8
LD-3528-300-20-NE4P				4000 K					
LD-3528-300-20-CB				3200 K					
LD-3528-300-65-ZB		280 lm/m		6500 K	65				
LD-3528-300-65-NE4				4000 K					
LD-3528-300-65-CB				3200 K					
LD-3528-300-20-NI	-	modrá/ modrá/ kék/ albastru							
LD-3528-600-20-ZB	12 VDC 9,6 W/1 m 28 W/5 m	550 lm/m		6500 K	20	120°	120/m	2,5	8
LD-3528-600-20-NE4				4000 K					
LD-3528-600-20-CB				3200 K					
LD-3528-600-65-ZB		520 lm/m		6500 K	65				
LD-3528-600-65-NE4				4000 K					
LD-3528-600-65-CB				3200 K					
LD-2835-300-20-ZB	12 VDC 6 W/1 m 21 W/5 m	750 lm/m		6500 K	20	120°	60/m	5	8
LD-2835-300-20-NE4P				4000 K					
LD-2835-300-20-CB				3200 K					
LD-2835-300-65-ZB		700 lm/m		6500 K	65				
LD-2835-300-65-NE4				4000 K					
LD-2835-300-65-CB				3200 K					
LD-2835-300-20-CBN	12 VDC 11 W/1 m 33 W/5 m	1000 lm/m		6500 K	20	120°	120/m	2,5	8
LD-2835-300-20-ZBN				4000 K					
LD-2835-300-20-NE4N				3200 K					
LD-2835-300-65-CBN		900 lm/m		6500 K	65				
LD-2835-300-65-ZBN				4000 K					
LD-2835-300-65-NE4N				3200 K					
LD-2835-600-20-ZB	12 VDC 19 W/1 m 60 W/5 m	1600 lm/m		6500 K	20	120°	120/m	2,5	10
LD-2835-600-20-NE4				4000 K					
LD-2835-600-20-CB				3200 K					
LD-2835-600-65-ZB		1350 lm/m		6500 K	65				
LD-2835-600-65-NE4				4000 K					
LD-2835-600-65-CB				3200 K					







LD-2835-600-5MM-20-ZB	12 VDC 10 W/1 m 33 W/5 m	750 lm/m	● 6500 K	20	120°	5	120/m	2,5
LD-2835-600-5MM-20-NE4			● 4000 K					
LD-2835-600-5MM-20-CB			● 3200 K					
LD-2835-60-60-20-CCT	12 VDC 10 W/1 m 30 W/5 m	700 lm/m	● 3200 K ● 6500 K	20		8		5
LD-5050-300-20-ZB	12 VDC 14,4 W/1 m 44 W/5 m	900 lm/m	● 6500 K	65	120°	10	60/m	5
LD-5050-300-20-NE4			● 4000 K					
LD-5050-300-20-CB			● 3200 K					
LD-5050-300-65-ZB	12 VDC 16 W/1 m 50 W/5 m	850 lm/m	● 6500 K	65	120°	10	60/m	5
LD-5050-300-65-NE4			● 4000 K					
LD-5050-300-65-CB			● 3200 K					
LD-5630-300-20-ZB	12 VDC 16 W/1 m 50 W/5 m	1750 lm/m	● 6500 K	20	120°	10	60/m	5
LD-5630-300-20-NE4			● 4000 K					
LD-5630-300-20-CB			● 3200 K					
LD-5630-300-65-ZB	12 VDC 16 W/1 m 50 W/5 m	1700 lm/m	● 6500 K	65	120°	10	60/m	5
LD-5630-300-65-NE4			● 4000 K					
LD-5630-300-65-CB			● 3200 K					
LD-3014-1200-20-ZB	12 VDC 19 W/1 m 53 W/5 m	1300 lm/m	● 6500 K	20	120°	10	240/m	1,25
LD-3014-1200-20-NE4			● 4000 K					
LD-3014-1200-20-CB			● 3200 K					
LD-RGB-150-20	12 VDC max 7,2 W/1 m 22 W/5 m	-	● RGB	65	120°	10	30/m	10
LD-RGB-150-65			● RGB					
LD-RGBW-300-20	12 VDC max 17 W/1 m	-	● RGBW	20	120°	10	60/m	5



LED pásek FLASH (s blikáním) 50 m  
 LED pásik FLASH 50 m  
 FLASH LED szalag 50 m  
 Bandă LED FLASH 50 m



LD-3528-300-20-ZB-50	12 VDC 4,8 W/m	300 lm/m		20	120°	8 mm	60/m	5	
LD-3528-300-20-NE4P-50									
LD-3528-300-20-CB-50									
LD-3528-600-20-ZB-50	12 VDC 9,6 W/1 m	550 lm/m		20	120°	8 mm	120/m	5	
LD-3528-600-20-NE4-50									
LD-3528-600-20-CB-50									
LD-2835-300-20-ZB-50	12 VDC 6 W/m	750 lm/m		20	120°	8 mm	60/m	5	
LD-2835-300-20-NE4P-50									
LD-2835-300-20-CB-50									
LD-5050-300-20-NE4-50	12VDC 14,4W/m	900 lm/m		20	120°	10 mm	60/m	5	
LD-5630-300-20-NE4-50	12VDC 16W/m	1750 lm/m							



LED pásek FLASH (s blikáním)  
 LED pásik FLASH  
 FLASH LED szalag  
 Bandă LED FLASH



LD-2835-24V-300-20-ZB	24 V DC 12 W/1 m 48 W/5 m	780 lm/m		20	120°	8 mm	60/m	10	
LD-2835-24V-300-20-NE4									
LD-2835-24V-300-20-CB									
LD-2835-24V-600-20-ZB	24 V DC 21 W/1 m 78 W/5 m	1350 lm/m		20	120°	10 mm	120/m	5	
LD-2835-24V-600-20-NE4									
LD-2835-24V-600-20-CB									



Sada RGB, páska LED 5 m, zkoušeč, napájecí zdroj, ovladač  
 Súprava RGB, LED pásik 5 m, radič, adaptér, ovládač  
 RGB készlet, 5 m-es LED-szalag, vezérlő, tápegység, távirányító  
 Set RGB, bandă LED de 5 m, controler, sursă de alimentare, telecomandă

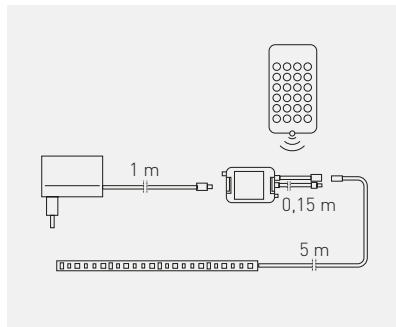

LD-ZL5RGB150-00	12V	RGB	plast, plast, műanyag, plastic	10	10



LED pásek COB  
LED pásik COB  
LED szalag COB  
Bandă LED COB

NEW



LD-COB12V-20-ZBN	12V, 8W/m	600 lm/m	● 6500 K	IP20	1800	8 mm	320 led/m	2,5 cm
LD-COB12V-20-CBN		600 lm/m	● 2700 K					
LD-COB12V-20-NEN		700 lm/m	● 4000 K					
LD-COB12V-20-ZBPQ	12V, 10W/m	800 lm/m	● 6500 K				480 led/m	
LD-COB12V-20-CBPQ		750 lm/m	● 2700 K					
LD-COB12V-20-NEPQ		800 lm/m	● 4000 K					



LED pásek COB  
LED pásik COB  
LED szalag COB  
Bandă LED COB

NEW



LD-COB24V-20-ZBN	24V, 8W/m	650 lm/m	● 6500 K	IP20	1800	8 mm	320 led/m	2,5 cm
LD-COB24V-20-CBN		600 lm/m	● 2700 K					
LD-COB24V-20-NEN		600 lm/m	● 4000 K					



LED pásek NEON FLEX  
 LED pásik NEON FLEX  
 LED szalag NEON FLEX  
 Bandă LED NEON FLEX



LD-NF-12V6x12-65-ZB	12 VDC 12 W/1 m 40 W/5 m	200 lm/m	● 6500 K	65	120°	6 mm	120/m	1
LD-NF-12V6x12-65-NE			● 4000 K					
LD-NF-12V6x12-65-CB			● 3000 K					
LD-ZASNF-12V6X12-65	koncovka, koncový kryt, végzáró, capac final							
LD-UNF-12V6X12-6X	úchytka, úchytka, rögzítő, dispositif de fixare,							



LD-ZASNF-12V6X12-65



LD-UNF-12V6X12-6X

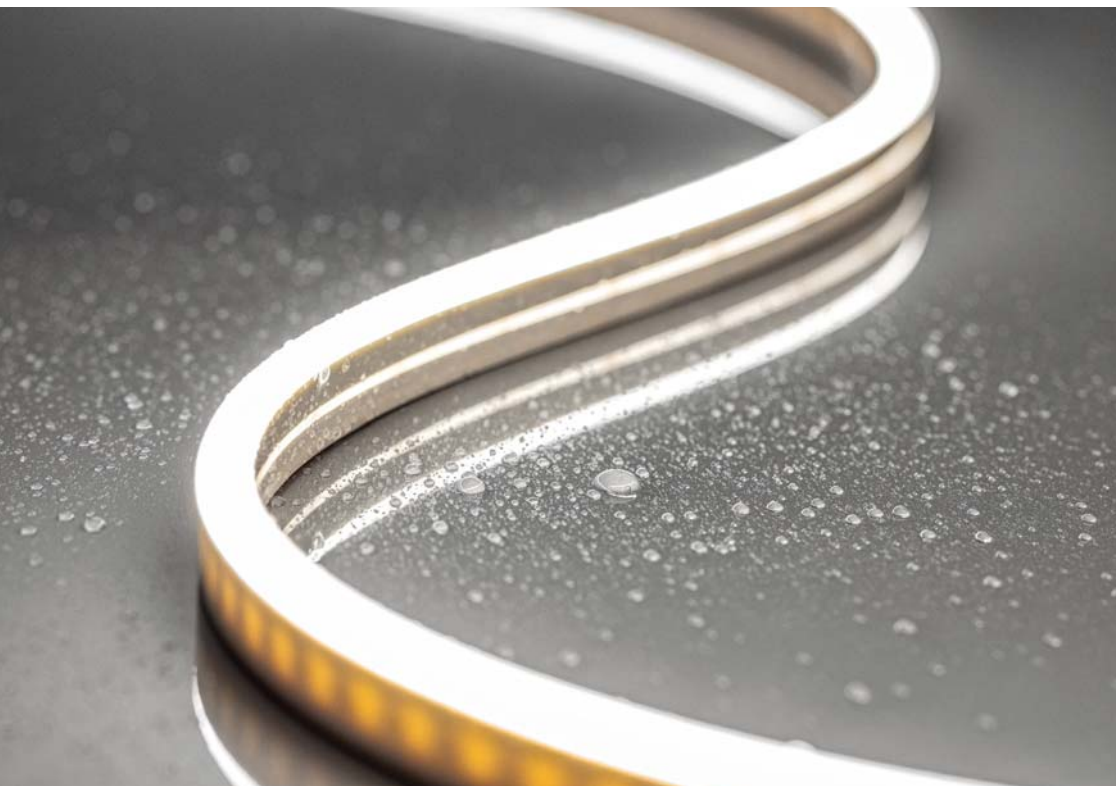

Profil GLAX lineární  
 Profil GLAX lineárny  
 GLAX egyenes profil  
 Profil GLAX liniar

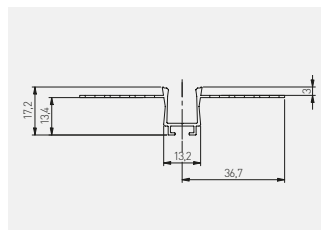
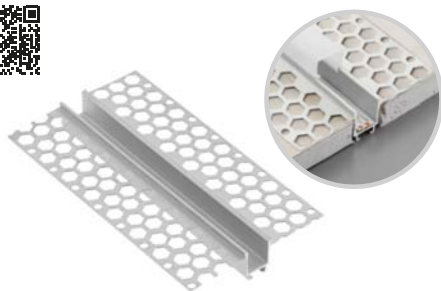

PA-GLAXGKL3M-00C	3	profil, profil, profil, profil	stříbrný, stříborný, ezüst, argintiu	hliník, hliník, alumínium, aluminiu	
PA-CPGLAXL-00	-	přímý konektor, priamy konektor, egyenes csatlakozó, conector drept			
PA-CPGLAXAH-00	-	horizontální konektor, horizontálny konektor, vízszintes csatlakozó, conector orizontal			
PA-CPGLAXAV-00	-	vertikální konektor, vertikálny konektor, függőleges csatlakozó, conector vertical			
PA-OSMLGLAXM3M-00	3	kryt, kryt, takaró, dispensor	mléčná bílá, mliečna biela, tejfehér, alb mat	PC	
PA-OSMLGLAXMK3M-00	3	čtvercový kryt, štvorcový kryt, négyzet alakú takaró, dispensor pătrat			
PA-OSMLGLAXM03M-00	3	kulatý kryt, okružlý kryt, kerek takaró, dispensor rotund			
PA-OSMLGLAXT3M-00	3	trojúhelníkový kryt, trojuholníkový kryt, háromszög alakú takaró, dispensor triunghiular			
PA-OSCLGLAXM3M-00	3	kryt mini, kryt mini, mini takaró, dispensor mini	černá, čierna, fekete, negru		

Kryty / Kryty / Takarók / Dispersoare:

Příslušenství / Príslušenstvo / Kiegészítők / Accesorii:

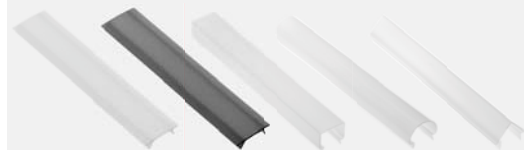

PA-OSMLGLAXM3M-00 PA-OSCLGLAXM3M-00 PA-OSMLGLAXMK3M-00 PA-OSMLGLAXM03M-00 PA-OSMLGLAXT3M-00

PA-CPGLAXL-00 PA-CPGLAXAH-00 PA-CPGLAXAV-00



Profil GLAX stěnový  
 Profil GLAX stěnový  
 GLAX řadový profil  
 Profil GLAX de perete

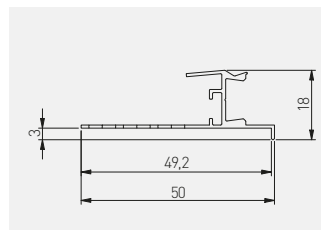
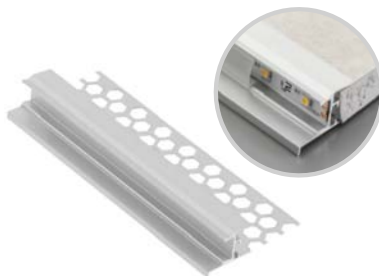

PA-GLAXGKS3M-00C	3	profil, profil, profil, profil	stříbrný, stříborný, ezüst, argintiu	hliník, hliník, aluminium, aluminium
PA-CPGLAXL-00	-	přímý konektor, priamy konektor, egyenes csatlakozó, conector drept		
PA-CPGLAXAH-00	-	horizontální konektor, horizontálny konektor, vízszintes csatlakozó, conector orizontal		
PA-CPGLAXAV-00	-	vertikální konektor, vertikálny konektor, függőleges csatlakozó, conector vertical		
PA-OSMLGLAXM3M-00	3	kryt, kryt, takaró, dispensor	mléčná bílá, mliečna biela, tejfehér, alb mat	PC
PA-OSMLGLAXMK3M-00	3	čtvercový kryt, štvorcový kryt, négyzet alakú takaró, dispensor pătrat		
PA-OSMLGLAXM03M-00	3	kulatý kryt, okružlý kryt, kerek takaró, dispensor rotund		
PA-OSMLGLAXT3M-00	3	trojúhelníkový kryt, trojuholníkový kryt, háromszög alakú takaró, dispensor triunghiular		
PA-OSCLGLAXM3M-00	3	kryt mini, kryt mini, mini takaró, dispensor mini	černá, Čierna, feketé, negru	

Kryty / Kryty / Takarók / Dispersoare:

Příslušenství / Príslušenstvo / Kiegészítők / Accesorii:

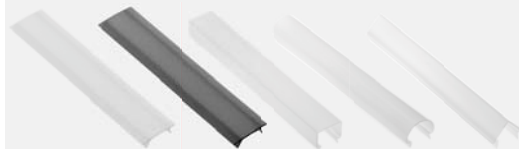

PA-OSMLGLAXM3M-00 PA-OSCLGLAXM3M-00 PA-OSMLGLAXMK3M-00 PA-OSMLGLAXM03M-00 PA-OSMLGLAXT3M-00





DO  
*something*  
(today)  
THAT YOUR  
FUTURE SELF  
WILL  
THANK YOU  
*for*

BE  
BRAVE

Better  
days are  
coming.  
They're called  
Saturday and  
Sunday.

Smile  
you  
are  
beaut-  
iful.

the  
time  
is  
now.

DO  
WHAT  
YOU  
LOVE.♥

A  
you  
is  
BRA

Profil GLAX stropný  
 Profil GLAX stropný  
 GLAX mennyezeti profil  
 Profil GLAX de plafon

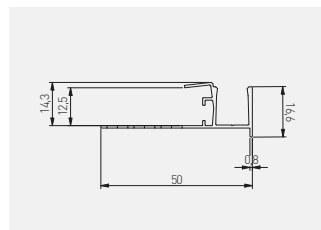
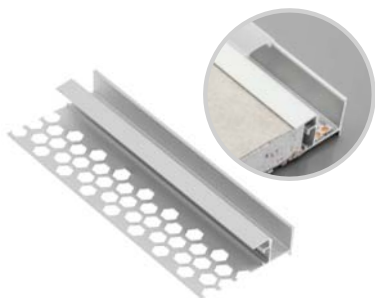

PA-GLAXGW3M-00C	3	profil, profil, profil, profil	stříbrný, stříborný, ezüst, argintiu	hliník, hliník, aluminium, aluminium
PA-CPGLAXL-00	-	přímý konektor, priamy konektor, egyenes csatlakozó, conector drept		
PA-CPGLAXAH-00	-	horizontální konektor, horizontálny konektor, vízszintes csatlakozó, conector orizontal		
PA-CPGLAXAV-00	-	vertikální konektor, vertikálny konektor, függőleges csatlakozó, conector vertical	nerezová ocel, nehrdzavejúca oceľ, rozsdamentes acél, oțel inoxidabil	
PA-OSMLGLAXM3M-00	3	kryt, kryt, takaró, dispersor		
PA-OSMLGLAXMK3M-00	3	čtvercový kryt, štvorcový kryt, négyzet alakú takaró, dispersor pătrat	mléčná bílá, mliečna biela, tejfehér, alb mat	PC
PA-OSMLGLAXM03M-00	3	kulatý kryt, okrúhly kryt, kerek takaró, dispersor rotund		
PA-OSMLGLAXT3M-00	3	trojúhelníkový kryt, trojuholníkový kryt, háromszög alakú takaró, dispersor triunghiular		
PA-OSCLGLAXM3M-00	3	kryt mini, kryt mini, mini takaró, dispersor mini	černá, čierna, feketé, negru	

Kryty / Kryty / Takarók / Dispersoare:

Příslušenství / Príslušenstvo / Kiegészítők / Accesorii:

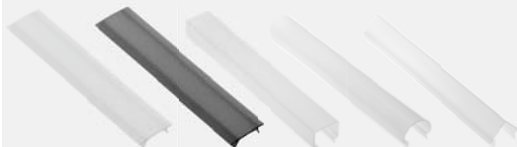

PA-CPGLAXL-00 PA-CPGLAXAH-00 PA-CPGLAXAV-00

PA-OSMLGLAXM3M-00 PA-OSCLGLAXM3M-00 PA-OSMLGLAXMK3M-00 PA-OSMLGLAXM03M-00 PA-OSMLGLAXT3M-00



Profil GLAX sklupný vnútřní  
 Profil GLAX uhlový vnútorný  
 GLAX sarok profil, belső  
 Profil GLAX unghiular, de interior

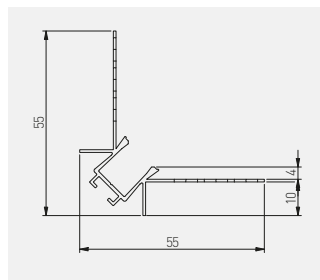
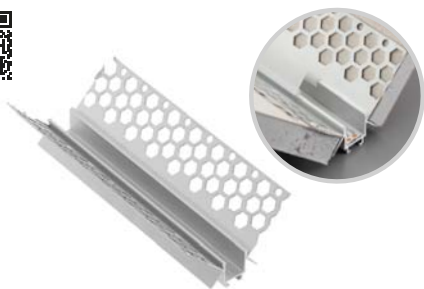

PA-GLAXGKWK3M-00C	3	profil, profil, profil, profil	stříbrný, stříborný, ezüst, argintiu	hliník, hliník, aluminium, aluminiu	
PA-CPGLAXL-00	-	přímý konektor, priamy konektor, egyenes csatlakozó, conector drept		mléčná bílá, mliečna biela, tejfehér, alb mat	nerezová ocel, nehrdzavejúca ocel, rozsdamentes acél, oțel inoxidabil
PA-CPGLAXAH-00	-	horizontální konektor, horizontálny konektor, vízszintes csatlakozó, conector orizontal			
PA-CPGLAXAV-00	-	vertikální konektor, vertikálny konektor, függőleges csatlakozó, conector vertical			
PA-OSMLGLAXM3M-00	3	kryt, kryt, takaró, dispensor	černá, čierna, fekete, negru	PC	
PA-OSMLGLAXMK3M-00	3	čtvercový kryt, štvorcový kryt, négyzet alakú takaró, dispensor pátrat			
PA-OSMLGLAXM03M-00	3	kulatý kryt, okružný kryt, kerek takaró, dispensor rotund			
PA-OSMLGLAXT3M-00	3	trojúhelníkový kryt, trojuholníkový kryt, háromszög alakú takaró, dispensor triunghiular			
PA-OSCLGLAXM3M-00	3	kryt mini, kryt mini, mini takaró, dispensor mini			

Kryty / Kryty / Takarók / Dispersoare:

Příslušenství / Príslušenstvo / Kiegészítők / Accesorii:

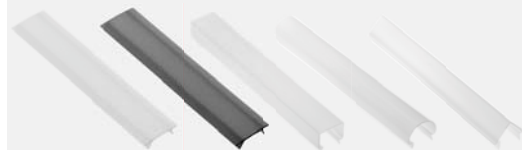

PA-CPGLAXL-00 PA-CPGLAXAH-00 PA-CPGLAXAV-00

PA-OSMLGLAXM3M-00 PA-OSCLGLAXM3M-00 PA-OSMLGLAXMK3M-00 PA-OSMLGLAXM03M-00 PA-OSMLGLAXT3M-00



Profil GLAX sklupný vnější  
 Profil GLAX uhlový vonkajší  
 GLAX sarok profil, külső  
 Profil GLAX unghiular, de exterior

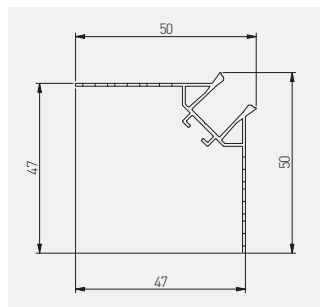
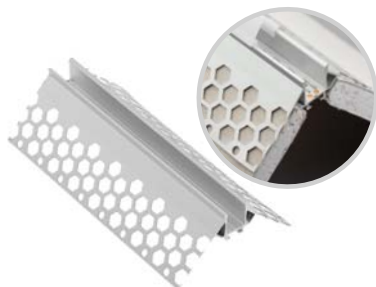

PA-GLAXGKZK3M-00C	3	profil, profil, profil, profil		hliník, hliník, aluminium, aluminiu
PA-CPGLAXL-00	-	přímý konektor, priamy konektor, egyenes csatlakozó, conector drept	stříbrný, strieborný, ezüst, argintiu	nerezová ocel, nehrdzavejúca oceľ, rozsdamentes acél, oțel inoxidabil
PA-CPGLAXAH-00	-	horizontální konektor, horizontálny konektor, vízszintes csatlakozó, conector orizontal		
PA-CPGLAXAV-00	-	vertikální konektor, vertikálny konektor, függőleges csatlakozó, conector vertical		
PA-OSMLGLAXM3M-00	3	kryt, kryt, takaró, dispersor	mléčná bílá, mliečna biela, tejfehér, alb mat	PC
PA-OSMLGLAXMK3M-00	3	čtvercový kryt, štvorcový kryt, négyzet alakú takaró, dispersor pătrat		
PA-OSMLGLAXM03M-00	3	kulatý kryt, okružlý kryt, kerek takaró, dispersor rotund		
PA-OSMLGLAXT3M-00	3	trojúhelníkový kryt, trojuhelníkový kryt, háromszög alakú takaró, dispersor triunghiular		
PA-OSCLGLAXM3M-00	3	kryt mini, kryt mini, mini takaró, dispersor mini	černá, čierna, fekete, negru	

Kryty / Kryty / Takarók / Dispersoare:

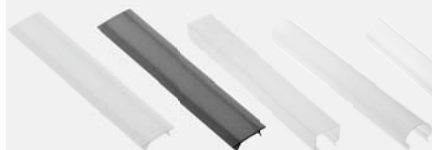

PA-OSMLGLAXM3M-00

PA-OSCLGLAXM3M-00

PA-OSMLGLAXMK3M-00

PA-OSMLGLAXM03M-00

PA-OSMLGLAXT3M-00

Příslušenství / Príslušenstvo / Kiegészítők / Accesorii:



PA-CPGLAXL-00

PA-CPGLAXAH-00

PA-CPGLAXAV-00

Profil GLAX přisazený mikro  
 Profil GLAX povrchový mikro  
 GLAX micro profil, falon kívüli  
 Profil GLAX montat aparent, micro

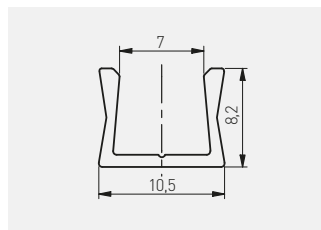
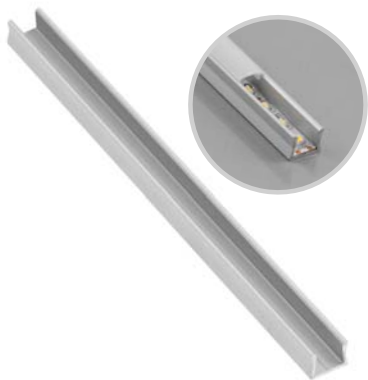

Úzká linie světla. Žádné viditelné světelné body díky vyhrazenému 5mm LED pásku.  
 Úzka linia svetla. Žiadne viditeľné svetelné body vďaka vyhrazenému 5 mm LED pásku.  
 Keskeny fényvonal. Nincsenek látható fénypontok az 5 mm-es LED szalag miatt.  
 Linie îngustă de lumină. Nu există puncte vizibile de lumină datorită benzii LED de 5 mm

PA-GLAXMICNK-AL	2	profil, profil, profil, profil	stříbrný, stříborný, ezüst, argintiu	hliník, hliník, aluminium, aluminiu
PA-GLAXMICNK3M-AL	3			
PA-OSMLGLAXMIC-00N	2	kryt mikro, kryt mikro, mikro takaró, dispensor micro	mléčná bílá, mliečna biela, tejfehér, alb mat	PC
PA-OSMLGLAXMIC3M-00N	3			
PA-ZASGLAXMICNK-00	-	koncovka, koncový kryt, végzáró, capac final	šedá, sivá, szürke, gri	ABS
PA-SPRGLAXMIC-00	-	úchytka, úchytka, rögzítő klipsz, dispozitiv de fixare	stříbrný, stříborný, ezüst, argintiu	nerezová ocel, nehrdzavejúca ocel, rozsdamentes acél, oțel inoxidabil

Kryty / Kryty / Takarók / Dispersoare:



PA-OSMLGLAXMIC-00N  
 PA-OSMLGLAXMIC3M-00N

Koncovky / Koncové kryty / Végzárók /  
 Capace finale:



PA-ZASGLAXMICNK-00

Úchytka / úchytka  
 / rögzítő klipsz /  
 dispozitiv de fixare:



PA-SPRGLAXMIC-00

Profil GLAX přisazený mini  
 Profil GLAX povrchový mini  
 GLAX mini profil, falon kvilüi  
 Profil GLAX mini montat aparent

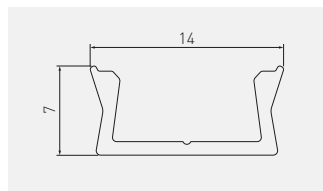

Šířka LED pásku max. 10 mm  
 Šířka LED pásika max. 10 mm  
 LED szalag szélessége max. 10 mm  
 Lățimea maximă a benzii LED 10 mm



PA-GLAXMNK-AL	2	profil, profil, profil, profil	stříbrný, stříborný, ezüst, argintiu	hliník, hliník, aluminium, aluminiu		
PA-GLAXMNK-AL-20M			černá, čierna, fekete, negru			
PA-GLAXMNK-AL-10			bílám, biela, fehéř, alb			
PA-GLAXMNK-AL-90			šampaňské, šampanské, pezsgó, șampanie			
PA-GLAXMNK3M-AL	3	profil, profil, profil, profil	stříbrný, stříborný, ezüst, argintiu			
PA-GLAXMNK3M-AL-20M			černá, čierna, fekete, negru			
PA-GLAXMNK3M-AL-10			bílám, biela, fehéř, alb			
PA-OSMLGLAXM-00	2	kryt mini, kryt mini, mini takaró, dispersor mini	mléčná bílá, mliečna biela, tejfehér, alb mat		PC	
PA-OSMLGLAXM3M-00	3		průhledný, priehľadný, átlátszó, transparent			
PA-OSTRGLAXM-00	2		čtvercový kryt, štvorcový kryt, négyzet alakú takaró, dispersor pätrat			mléčná bílá, mliečna biela, tejfehér, alb mat
PA-OSTRGLAXM3M-00	3					
PA-OSCLGLAXM-00	2			černá, čierna, fekete, negru		
PA-OSCLGLAXM3M-00	3					
PA-OSMLGLAXMK-00	2	čtvercový kryt, štvorcový kryt, négyzet alakú takaró, dispersor pätrat	mléčná bílá, mliečna biela, tejfehér, alb mat			
PA-OSMLGLAXMO-00				kulatý kryt, okružlý kryt, kerek takaró, dispersor rotund		
PA-ZASGLAXMNK-00	-	standardní koncovka, štandardný koncový kryt, alap végzáró, capac final standard	šedá / sivá / szürke / gri	ABS		
PA-ZASGLAXMNK-10			bílám, biela, fehéř, alb			
PA-ZASGLAXMNK-90			šampaňské, šampanské, pezsgó, șampanie			
PA-ZASGLAXMNK-20M			černá matná, čierna matná, matt fekete, negru mat			
PA-ZASGLAXMNNK-00	-	čtvercová koncovka, štvorcový koncový kryt, négyzet alakú végzáró, capac final pätrat	šedá / sivá / szürke / gri			
PA-ZASGLAXMNKO-00	-	kulatá koncovka, okružlý koncový kryt, kerek végzáró, capac final rotund	šedá / sivá / szürke / gri			
PA-SPRGLAXM-00	-	úchytka, úchytka, rögzítő klipsz, dispozitiv de fixare	stříbrný, stříborný, ezüst, argintiu		nerezová ocel, nehřdzavejüca ocel, rozsdamentes acél, oțel inoxidabil	

Kryty / Kryty / Takarók / Dispersoare:

PA-OSMLGLAXM-00  
 PA-OSMLGLAXM3M-00

PA-OSTRGLAXM-00  
 PA-OSTRGLAXM3M-00

PA-OSCLGLAXM-00  
 PA-OSCLGLAXM3M-00

PA-OSMLGLAXMO-00

PA-OSMLGLAXMK-00

Koncovky / Koncové kryty / Végzárók / Capace finale:

PA-ZASGLAXMNK-00

PA-ZASGLAXMNNK-00

PA-ZASGLAXMNKO-00

Úchytka / úchytka / rögzítő klipsz / dispozitiv de fixare:

PA-SPRGLAXM-00



Profil GLAX přisazený  
 Profil GLAX povrchový  
 GLAX profil, falon kivüli  
 Profil GLAX montat aparent

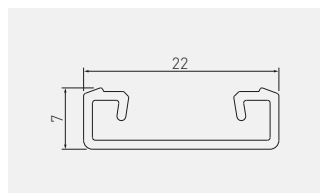

PA-GLAXNK-AL	2	profil, profil, profil, profil	sříbný, stříbrný, ezüst, argintiu	hliník, hliník, aluminium, aluminium
PA-GLAXNK3M-AL	3			
PA-OSMLGLAX-00	2	kryt mini, kryt mini, mini takaró, dispensor mini	mléčná bílá, mléčna biela, tejfehér, alb mat	PC
PA-OSMLGLAX3M-00	3			
PA-OSTRGLAX-00	2			
PA-OSTRGLAX3M-00	3	průhledný, priehľadný átlátszó, transparent		
PA-ZASGLAXNK-00	-	koncovka, koncový kryt, végzáró, capac final	šedá, sivá, szürke, gri	ABS

Kryty / Kryty / Takarók / Dispensore:



PA-OSMLGLAX-00  
 PA-OSMLGLAX3M-00

PA-OSTRGLAX-00  
 PA-OSTRGLAX3M-00

Koncovka / Koncový kryt / Végzáró / Capac final:



PA-ZASGLAXNK-00

Profil GLAX přisazený mini, vysoký  
 Profil GLAX povrchový mini, vysoký  
 GLAX mini profil, falon kivüli, magasított  
 Profil GLAX montat aparent mini, înalt

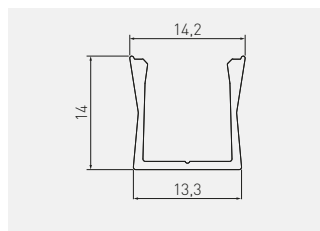

Žiadne viditeľné svetelné body  
 LED pásek o šírke max. 10 mm.  
 Žiadne viditeľné svetelné body  
 Šírka LED pásika max. 10 mm.  
 Látható fénypont nélkül  
 LED szalag szélesség max. 10 mm.  
 Fără puncte vizibile de lumină  
 Lățimea benzii LED maxim 10 mm.



PA-GLAXMNKW-AL	2	profil, profil, profil, profil	stříbrný, stříborný, ezüst, argintiu	hliník, hliník, aluminium, aluminium
PA-GLAXMNKW-AL-20M			černá, čierna, fekete, negro	
PA-GLAXMNKW-AL-10			bílám, biela, fehéř, alb	
PA-GLAXMNKW-AL-90			šampaňské, šampanské, pezsgő, șampanie	
PA-OSMLGLAXM-00	2	kryt mini, kryt mini, mini takaró, dispersor mini	mléčná bílá, mliečna biela, tejfehéř, alb mat	PC
PA-OSTRGLAXM-00			průhledný, priehľadný, átlátszó, transparent	
PA-OSCLGLAXM-00			černá, čierna, fekete, negro	
PA-ZASGLAXMNKW-00	-	koncevka, koncevó kryt, végzáró, capac final	šedá, sivá, szürke, gri	ABS
PA-ZASGLAXMNKW-10			bílám, biela, fehéř, alb	
PA-ZASGLAXMNKW-90			šampaňské, šampanské, pezsgő, șampanie	
PA-ZASGLAXMNKW-20M			černá matná, čierna matná, matt fekete, negro mat	
PA-SPRGLAXM-00	-	úchytka, úchytka, rögzítő klipsz, dispozitiv de fixare	stříbrný, stříborný, ezüst, argintiu	nerezová ocel, nehrdzavejúca ocel, rozsdamentes acél, oțel inoxidabil

Kryty / Kryty / Takarók / Dispersoare:

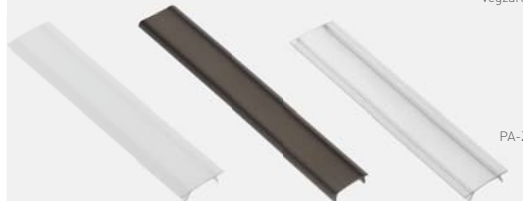

PA-OSMLGLAXM-00

PA-OSCLGLAXM-00

PA-OSTRGLAXM-00

Koncevka / Koncevó kryt /  
Végzáró / Capac final:



PA-ZASGLAXMNKW-00

Úchytka / úchytka / rögzítő  
klipsz / dispozitiv de fixare:



PA-SPRGLAXM-00

Profil GLAX vestavný mikro  
 Profil GLAX vstavaný mikro  
 GLAX micro profil, sülyesztett  
 Profil GLAX încastrat, micro

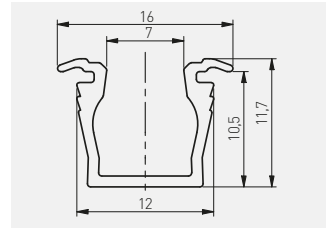

Úzká línie svôta. Źadné viditeľné svetelné body díky vyhradenému 5mm LED pásku  
 Úzka línia svôta. Źiadne viditeľné svetelné body vďaka vyhradenému 5 mm LED pásku  
 Keskeny fényvonal. Nincsenek látható fénypontok az 5 mm-es LED szalag miatt  
 Line îngustă de lumină. Nu există puncte vizibile de lumină datorită benzii LED de 5 mm



PA-GLAXMIC-AL	2	profil, profil, profil, profil	stříbrný, stříborný, ezüst, argintiu	hliník, hliník, alumínium, aluminiu
PA-GLAXMIC3M-AL	3			
PA-OSMLGLAXMIC-00N	2	kryt mikro, kryt mikro, mikro takaró, dispersor micro	mléčná bílá, mliečna biela, tejfehér, alb mat	PC
PA-OSMLGLAXMIC3M-00N	3			
PA-ZASGLAXMIC-00	-	koncovka, koncový kryt, végzáró, capac final	šedá / sivá / szürke / gri	ABS

Kryty / Kryty / Takarók / Dispersoare:



PA-OSMLGLAXMIC-00N  
 PA-OSMLGLAXMIC3M-00N

Koncovka / Koncový kryt / Végzáró / Capac final:



PA-ZASGLAXMIC-00

Profil GLAX vestavný  
 Profil GLAX vstavaný  
 GLAX profil, süllyesztett  
 Profil GLAX încastrat

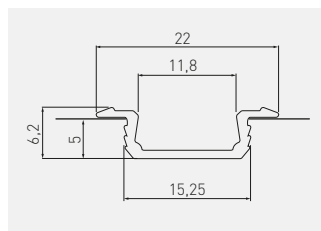

PA-GLAX-AL	2	profil, profil, profil, profil	stříbrný, stříborný, ezüst, argintiu	hliník, hliník, aluminium, aluminium	
PA-GLAX-AL-20M			černá, čierna, fekete, negro		
PA-GLAX-AL-10			bílám, biela, fehé, alb		
PA-GLAX-AL-90			šampaňské, šampanské, pezsgó, șampanie		
PA-GLAX3M-AL	3	profil	stříbrný, stříborný, ezüst, argintiu		
PA-GLAX3M-AL-20M			černá, čierna, fekete, negro		
PA-GLAX3M-AL-10			bílám, biela, fehé, alb		
PA-OSMLGLAX-00	2	kryt, kryt, takaró, dispersor	mléčná bílá, mliečna biela, tejfehér, alb mat		PC
PA-OSMLGLAX3M-00	3		průhledný, priehľadný, átlátszó, transparent		
PA-OSTRGLAX-00	2			černá, čierna, fekete, negro	
PA-OSTRGLAX3M-00	3				
PA-OSCLGLAX-00	2				
PA-OSCLGLAX3M-00	3				
PA-ZASGLAX-00	-	koncovka, koncový kryt, végzáró, capac final	šedá, sivá, szürke, gri	ABS	
PA-ZASGLAX-10			bílám, biela, fehé, alb		
PA-ZASGLAX-90			šampaňské, šampanské, pezsgó, șampanie		
PA-ZASGLAX-20M			černá matná, čierna matná, matt fekete, negro mat		

Kryty / Kryty / Takarók / Dispersoare:

Koncovka / Koncový kryt / Végzáró / Capac final:



PA-OSMLGLAX-00  
 PA-OSMLGLAX3M-00

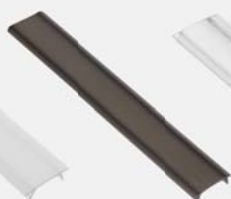

PA-OSCLGLAX-00



PA-OSTRGLAX-00  
 PA-OSTRGLAX3M-00



PA-ZASGLAX-00

Profil GLAX vestavný, vysoký  
 Profil GLAX vstavaný, vysoký  
 GLAX profil, súľyesztett, magasított  
 Profil GLAX încastrat, înalt

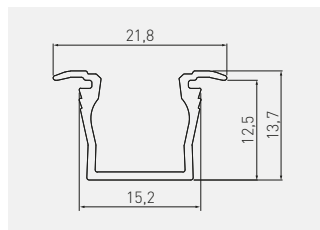

Žiadne viditeľné svetelné body.  
 LED pásek o šírke max. 10 mm.  
 Žiadne viditeľné svetelné body.  
 Šírka LED pásika max. 10 mm.  
 Láttható fénypont nélkül  
 LED szalag szélesség max. 10 mm.  
 Fără puncte vizibile de lumină.  
 Lățimea benzii LED maxim 10 mm.

					
PA-GLAXMW-AL	2	profil, profil, profil, profil	stříbrný, stříborný, ezüst, argintiu		hliník, hliník, aluminium, aluminium
PA-GLAXMW-AL-20M			černá, čierna, fekete, negru		
PA-GLAXMW-AL-10			bílám, biela, fehér, alb		
PA-GLAXMW-AL-90			šampaňské, šampanské, pezsgó, șampanie		
PA-OSCLGLAXM-00	2	kryt mini, kryt mini, mini takaró, dispersor mini	černá, čierna, fekete, negru		PC
PA-OSMLGLAXM-00		čtvercový kryt, štvorcový kryt, négyzet alakú takaró, dispersor pătrat	mléčná bílá, mliečna biela, tejfehér, alb mat		
PA-OSTRGLAXM-00		kryt mini, kryt mini, mini takaró, dispersor mini	průhledný, priehľadný, átlátszó, transparent		
PA-ZASGLAXMW-00	-	standardní koncovka, štandardný koncový kryt, alap végzáró, capac final standard	šedá, sivá, szürke, gri		ABS
PA-ZASGLAXMW-10			bílám, biela, fehér, alb		
PA-ZASGLAXMW-90			šampaňské, šampanské, pezsgó, șampanie		
PA-ZASGLAXMW-20M			černá matná, čierna matná, matt fekete, negru mat		
PA-ZASGLAXMWK-00	-	čtvercová koncovka, štvorcový koncový kryt, négyzet alakú végzáró, capac final pătrat	šedá, sivá, szürke, gri		

Kryty / Kryty / Takarók / Dispersoare:

Koncovka / Koncový kryt / Végzáró / Capac final:

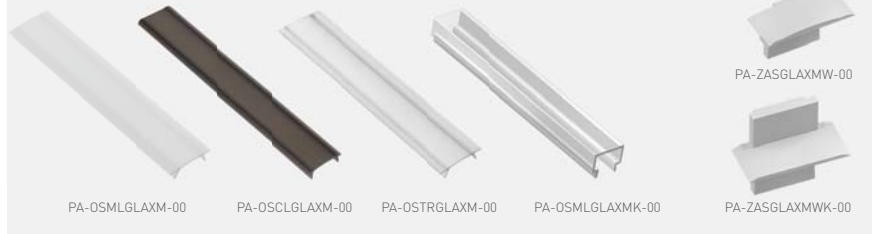

Profil GLAX tyčový  
 Profil GLAX drážkový  
 GLAX profil, rúd tipus  
 Profilul pentru garderoba GLAX

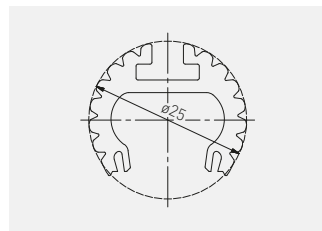

možnosti montáže  
 možnosti montáže  
 szerelési lehetőségek  
 opțiuni de asamblare ca

- tyč ve skříni
- tyč v skřini
- táborrúdként a szekrényben
- tijă în dulap
- závěsné svítidlo
- závesné svítidlo
- függesztett lámpatestként
- corp de iluminat suspendat

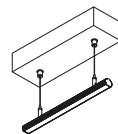
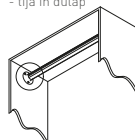

PA-GLAXDR-AL	2	profil, profil, profil, profil	stříbrný, stříborný, ezüst, argintiu	hliník, hliník, alumíniu, aluminiu
PA-OSMLGLAX-00		kryt, kryt, takaró, dispersor	mléčná bílá, mliečna biela, tejfehér, alb mat	PC
PA-OSTRGLAX-00			průhledný, priehľadný, átlátszó, transparent	
PA-ZASGLAXDR-00	-	koncovka, koncový kryt, végzáró, capac final	šedá, sivá, szürke, gri	ZnAl
PA-ROZGLAX-53	-	Rozетка, Rozетка, Sín csatlakozó aljzat, Priză de șină		
PA-ROZGLAXP-53	-	Rozетка PREMIUM, Rozетка PREMIUM, Priză de șină, PREMIUM, PREMIUM, Sín csatlakozó aljzat		
PA-ZAWGLAXDR-00	1,5	závěs, záves, függesztő, suspensie	chrom, chróm, króm, crom	ocel, ocef, acél, oțel

Kryty / Kryty / Takarók / Dispersoare:

Koncovka / Koncový kryt / Végzáró / Capac final:

Rozетка / Rozетка / Sín csatlakozó aljzat / Priză de șină:

Závěs / Záves / Függesztő / Suspensie:



PA-OSMLGLAX-00

PA-OSTRGLAX-00



PA-ZASGLAXDR-00



PA-ROZGLAX-53



PA-ROZGLAXP-53



PA-ZAWGLAXDR-00

Profil GLAX s chladičom  
 Profil GLAX s radiátorom  
 GLAX profil, hőelnyelő bordázattal  
 Profil GLAX cu radiator

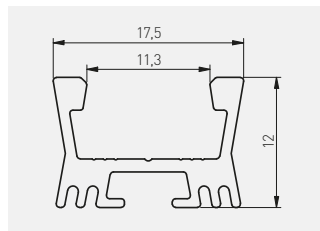

Vyhradený difúzor, ktorý zužuje vyzáračací uhol na 60 stupňů.  
 Možnosť zavesení svietidla na lanku.  
 Vyhradený difúzor, ktorý zužuje uhol svietenia na 60 stupňov.  
 Možnosť zavesenia svietidla na lanku.  
 A sugárzási szögét 60 fokra szűkítő lencse.  
 Feltűgésztesí lehetőség vonalas elrendezésben  
 Lentila pentru restrângerea unghiul fasciculului la 60 de grade.  
 Posibilitate de a suspenda corpul de iluminat in linii.

PA-GLAXRAD-AL	2	profil, profil, profil, profil	stříbrný, stříborný, ezüst, argintiu	hliník, hliník, alumíniúm, aluminiu	
PA-OSMLGLAXSO-00	2	kryt lenticulární, kryt lenticulární, lencsés takaró, dispersor lenticular	průhledný, priehľadný, átlátszó, transparent	PMMA	
PA-OSMLGLAX-00	2	kryt, kryt, takaró, dispersor	mléčná bílá, mliečna biela, tejfehér, alb mat	PC	
PA-OSTRGLAX-00			průhledný, priehľadný, átlátszó, transparent		
PA-ZASGLAXRAD-00	-	koncovka, koncový kryt, végzáró, capac final	šedá, sivá, szürke, gri	ABS	
PA-ZAWGLAXDR-00	1,5	závěs, záves, függesztő, suspensie	chrom, chróm, króm, crom	ocel, oceľ, acél, oțel	
PA-SPRGLAXM-00	-	úchytka, úchytka, rögzítő klipsz, dispozitive de fixare	stříbrný, stříborný, ezüst, argintiu	nerezová ocel, nehrdzavejúca oceľ, rozsdamentes acél, oțel inoxidabil	



Profil GLAX obvodový  
 Profil GLAX lemový  
 GLAX profil, peremre  
 Profil GLAX de margine

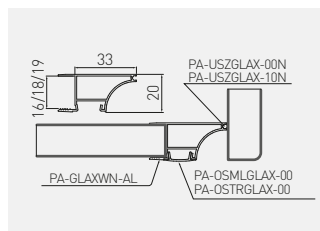

PA-GLAXWN-AL	18	2	profil, profil, profil, profil	stříbrný, stříborný, ezüst, argintiu	hliník, hliník, aluminium, aluminu
PA-GLAXWN3M-AL		3		černá, čierna, fekete, negru	
PA-GLAXWN3M-AL-20M				bílám, biela, fehéř, alb	
PA-GLAXWN3M-AL-10				nerez, nehrđzavejúca oceľ, inox, inox	
PA-GLAXWN3M-AL-06					
PA-GLAXWN16-AL	16	2		stříbrný, stříborný, ezüst, argintiu	
PA-GLAXWN19-AL	19				
PA-OSMLGLAX-00	-	2	kryt, kryt, takaró, dispersor	mléčná bílá, mliečna biela, tejfehéř, alb mat	PC
PA-OSTRGLAX-00				průhledný, priehľadný, átlátszó, transparent	
PA-OSCLGLAX-00		3		černá, čierna, fekete, negru	
PA-OSMLGLAX3M-00				mléčná bílá, mliečna biela, tejfehéř, alb mat	
PA-OSTRGLAX3M-00				průhledný, priehľadný, átlátszó, transparent	
PA-OSCLGLAX3M-00				černá, čierna, fekete, negru	
PA-USZGLAX-00N	-	10	Těsnění kabelu, Tesnenie kábla, Gumitömítés, Garnitură din cauciuc	černá, čierna, fekete, negru	EPDM
PA-USZGLAX-10N				bílám, biela, fehéř, alb	

Kryty / Kryty / Takarók / Dispersoare:

Těsnění kabelu / Tesnenie kábla / Gumitömítés /  
 Garnitură din cauciuc:



PA-OSMLGLAX-00  
 PA-OSMLGLAX3M-00

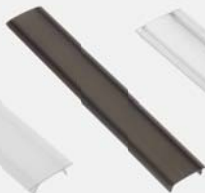

PA-OSCLGLAX-00  
 PA-OSCLGLAX3M-00



PA-OSTRGLAX-00



PA-USZGLAX-00N

ø2,5

PA-USZGLAX-10N

ø2,5



Profil GLAX sklopný, prísazený  
 Profil GLAX uhlový, povrchový  
 GLAX aluminium profil, sarokba illeszthető, falon kívüli  
 Profil de colț din aluminiu GLAX - montat aparent

meble  
 2019 plus  
 PRODUCT ROBU

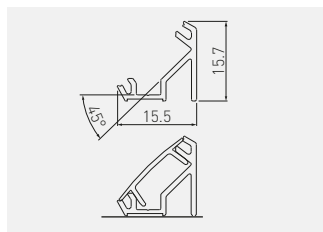

PA-GLAXNKKT-AL	2	profil, profil, profil, profil	stříbrný, stříborný, ezüst, argintiu		hliník, hliník, aluminium, aluminiu		
PA-GLAXNKKT-AL-20M			černá, čierna, fekete, negru				
PA-GLAXNKKT-AL-10			bílám, biela, fehér, alb				
PA-GLAXNKKT-AL-90			šampaňské, šampanské, pezsgő, șampanie				
PA-GLAXNKKT3M-AL	3	profil, profil, profil, profil	stříbrný, stříborný, ezüst, argintiu				
PA-GLAXNKKT3M-AL-20M			černá, čierna, fekete, negru				
PA-GLAXNKKT3M-AL-10			bílám, biela, fehér, alb				
PA-OSMLGLAX-00	2	kryt, kryt, takaró, dispersor	mléčná bílá, mliečna biela, tejfehér, alb mat				PC
PA-OSMLGLAX3M-00	3		průhledný, priehľadný, átlátszó, transparent				
PA-OSTRGLAX-00	2		trojúhelníkový kryt, trojuhelníkový kryt, háromszög alakú takaró, dispersor triunghiular	černá, čierna, fekete, negru			
PA-OSTRGLAX3M-00	3			mléčná bílá, mliečna biela, tejfehér, alb mat			
PA-OSCLGLAX-00	2			standardní koncovka, štandardný koncový kryt, alap végzáró, capac final standard	šedá, sivá, szürke, gri		
PA-OSCLGLAX3M-00	3				bílám, biela, fehér, alb		
PA-OSMLGLAXT-00	2	koncovka trojúhelníková, koncový kryt trojuhelníkový, háromszög alakú végzáró, capac final triunghiular	šampaňské, šampanské, pezsgő, șampanie	ABS			
PA-ZASGLAXNKKT-00	-		-		černá matná, čierna matná, matt fekete, negru mat		
PA-ZASGLAXNKKT-10		-			-	šedá, sivá, szürke, gri	
PA-ZASGLAXNKKT-90	-		-			úchytka, úchytka, rögzítő klipsz, dispozitiv de fixare	
PA-ZASGLAXNKKT-20M		-		-	stříbrný, stříborný, ezüst, argintiu	nerezová ocel, nehrdzavejúca ocel, rozsdamentes acél, otel inoxidabil	
PA-ZASGLAXNKKT-00	-		-		stříbrný, stříborný, ezüst, argintiu		
PA-SPRGLAXMIC-00		-		-	stříbrný, stříborný, ezüst, argintiu		

Kryty / Kryty / Takarók / Dispersoare:

Koncovky / Koncové kryty / Végzárók / Capace finale:

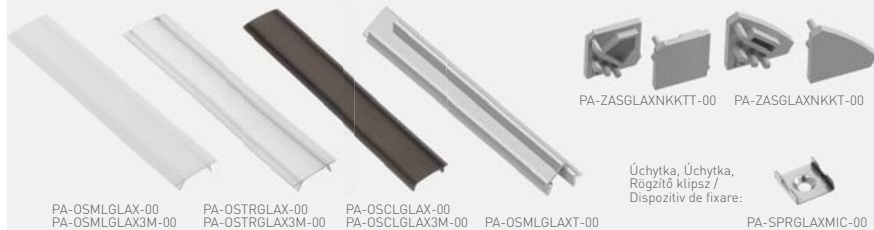

Profil GLAX soklový úzký, jednostranný  
 Profil GLAX soklový úzky, jednostranný  
 GLAX profil, sarokba illeszthető, egy oldalú, peremre illeszthető  
 Profil de colț GLAX, unilateral, montat pe margine

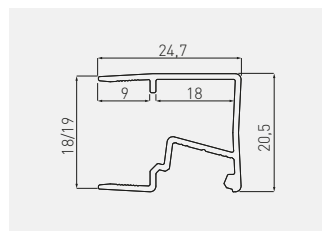

PA-GLAXMNB JW3M-AL	18	3	profil, profil, profil, profil	stříbrný, stříborný, ezüst, argintiu	hliník, hliník, alumínium, aluminiu
PA-GLAXMNB JW3M19-AL	19				
PA-OSMLGLAXM3M-00	-		kryt, kryt, takaró, dispersor	mléčná bílá, mliečna biela, tejfehér, alb mat	PC
PA-OSTRGLAXM3M-00	-			průhledný, priehľadný, átlátszó, transparent	

Kryty / Kryty / Takarók / Dispersoare:



PA-OSMLGLAXM3M-00



PA-OSTRGLAXM3M-00

Rohový profil GLAX, oboustranný, upevněný na hraně  
 Profil GLAX priečkový úzky  
 Sarokprofil GLAX, kétoldalás, éltre szerelhető  
 Profil de colț GLAX, cu două fețe, montat pe margine

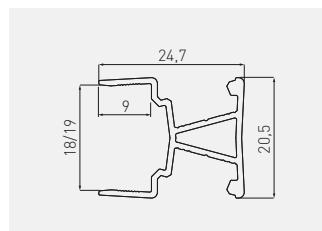
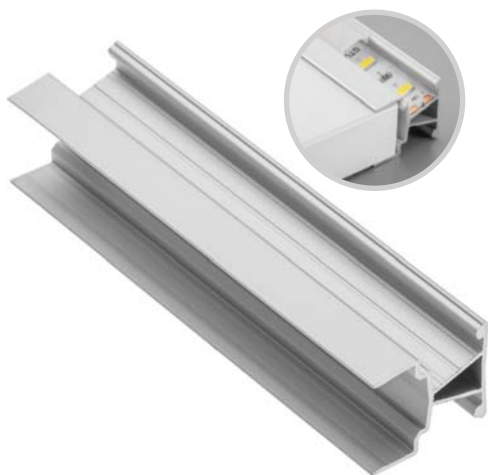

PA-GLAXMNBW3M-AL	18	3	profil, profil, profil, profil	stříbrný, stříborný, ezüst, argintiu	hliník, hliník, alumínium, aluminiu	
PA-GLAXMNBW3M19-AL	19					
PA-OSMLGLAXM3M-00	-			kryt mini, kryt mini, mini takaró, dispersor mini	mléčná bílá, mliečna biela, alb mat, tejfehér	PC
PA-OSTRGLAXM3M-00	-				průhledný, priehtadný, áttátszó, transparent	

Kryty / Kryty / Takarók / Dispersoare:



PA-OSMLGLAXM3M-00







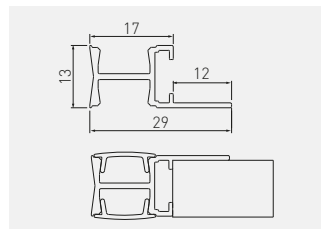

PA-OSTRGLAXM3M-00

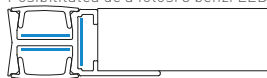
Profil GLAX policový mini  
 Profil GLAX policový mini  
 GLAX profil, mini, polcra  
 Profil raft GLAX mini



Možnosť použitia 3 LED pásků.  
 Możliwość użycia 3 LED pasków.  
 3 LED szalag használhatóak lehetősege  
 Posibilitatea de a folosi 3 benzi LED.



				
PA-GLAXMPK-AL	2	profil, profil, profil, profil	stříbrný, stříborný, ezüst, argintiu	hliník, hliník, alumíniúm, aluminiu
PA-OSMLGLAXM-00		kryt mini, kryt mini, mini takaró, dispensor mini	mléčná bílá, mliečna biela, tejfehér, alb mat	PC
PA-OSTRGLAXM-00			průhledný, priehľadný, átlátszó, transparent	

Kryty / Kryty / Takarók / Dispersoare:



PA-OSMLGLAXM-00



PA-OSTRGLAXM-00

Profil GLAX s nastaviteľným úhľom svietení  
 Profil GLAX s nastaviteľným uhlom svietenia  
 GLAX aluminium LED profil, állítható sugárzási szöggel  
 Profil GLAX cu unghi reglabil

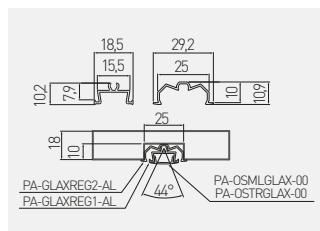

PA-GLAXREG1-AL	2	profil, profil, profil, profil	stříbrný, stříborný, ezüst, argintiu	hliník, hliník, alumíniom, alumíniu	
PA-GLAXREG2-AL					
PA-OSMLGLAX-00	2	kryt mini, kryt mini, mini takaró, dispensor mini	mléčná bílá, mliečna biela, tejfehér, alb mat	PC	
PA-OSTRGLAX-00			průhledný, priehľadný, átlátszó, transparent		

Kryty / Kryty / Takarók / Dispersoare:









PA-OSMLGLAX-00

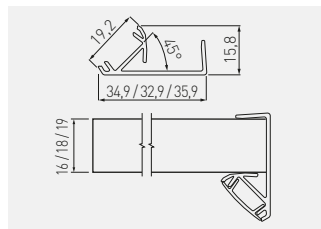

PA-OSTRGLAX-00

Profil GLAX soklový jednostranný  
 Profil GLAX soklový jednostranný  
 GLAX aluminium profil - egy oldalú  
 Profil de margine din aluminiu GLAX - pe o singură față



		 BOARD mm	 L m			
PA-GLAXNB3M16-AL		16	3	profil, profil, profil, profil	stříbrný, stříborný, ezüst, argintiu	hliník, hliník, aluminium, aluminium
PA-GLAXNB3M-AL		18	3			
PA-GLAXNB3M19-AL		19	3			
PA-OSMLGLAX3M-00		-	3	kryt, kryt, takarók, dispersor	mléčná bílá, mliečna biela, tefehér, alb mat	PC
PA-OSTRGLAX3M-00		-	3		průhledný, priehľadný, átlátszó, transparent	

Kryty / Kryty / Takarók / Dispersoare:









PA-OSMLGLAX3M-00

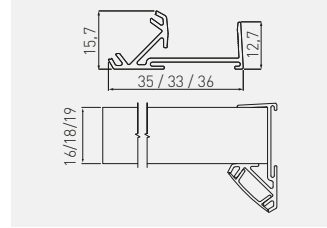

PA-OSTRGLAX3M-00

Profil GLAX soklový jednostranný, k vyplnění lemem  
 Profil GLAX soklový jednostranný, na vyplnenie lemom  
 GLAX aluminium profil - egy oldalú, opcionálisan furnér szalaggal kiegészíthető  
 Profil de margine din aluminiu GLAX - pe o singură față, opțiune de adaugare cant ABS



	 BOARD mm	 L m			
PA-GLAXNB JW3M16-AL	16	3	profil, profil, profil, profil	stříbrný, stříborný, ezüst, argintiu	hliník, hliník, aluminíum, aluminiu
PA-GLAXNB JW3M-AL	18	3			
PA-GLAXNB JW3M19-AL	19	3			
PA-OSMLGLAX3M-00	-	3	kryt, kryt, takaró, dispersor	mléčná bílá, mliečna biela, tejfehér, alb mat	PC
PA-OSTRGLAX3M-00	-	3		průhledný, priehľadný, átlátszó, transparent	

Kryty / Kryty / Takarók / Dispersoare:





PA-OSMLGLAX3M-00

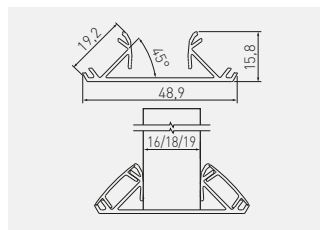

PA-OSTRGLAX3M-00

Profil GLAX přepážkový oboustranný  
 Profil GLAX priečkový dvojstranný  
 GLAX aluminium profil - két oldalú  
 Profil de margine din aluminiu GLAX - pe două fețe



	 BOARD mm	 L m			
PA-GLAXNBD3M16-AL	16	3	profil, profil, profil, profil	stříbrný, stříborný, ezüst, argintiu	hliník, hliník, aluminium, aluminiu
PA-GLAXNBD3M-AL	18	3			
PA-GLAXNBD3M19-AL	19	3			
PA-OSMLGLAX3M-00	-	3	kryt, kryt, takaró, dispersor	mléčná bílá, mliečna biela, tejlehér, alb mat	PC
PA-OSTRGLAX3M-00	-	3		průhledný, priehľadný, áttátszó, transparent	

Kryty / Kryty / Takarók / Dispersoare:



PA-OSMLGLAX3M-00



PA-OSTRGLAX3M-00



Profil GLAX přepážkový oboustranný, k vyplnění lemem

Profil GLAX dvojstranný, na vyplnenie lemom

GLAX aluminium profil - két oldalú, opcionálisan furnér szalaggal kiegészíthető

Profil de margine din aluminiu GLAX - pe două fețe, opțiune de adaugare cant ABS

**DIAMENT**  
meblarstwa  
2018

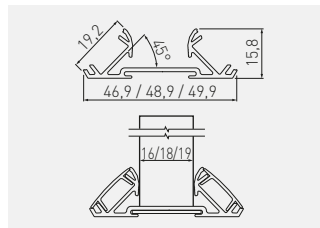

**BOARD**  
mm

**L**  
m



PA-GLAXNBDW3M16-AL	16	3	profil, profil, profil, profil	stříbrný, stříborný, ezüst, argintu	hliník, hliník, aluminium, aluminiu
PA-GLAXNBDW3M-AL	18	3			
PA-GLAXNBDW3M19-AL	19	3			
PA-OSMLGLAX3M-00	-	3	kryt, kryt, takaró, dispersor	mléčná bílá, mliečna biela, tejfehér, alb mat	PC
PA-OSTRGLAX3M-00	-			průhledný, priehľadný, áttátszó, transparent	

Kryty / Kryty / Takarók / Dispersoare:







PA-OSMLGLAX3M-00

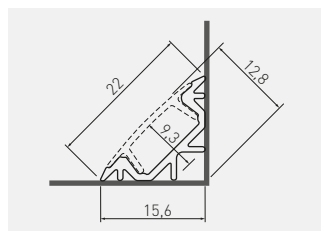

PA-OSTRGLAX3M-00

Profil GLAX sklápny  
 Profil GLAX uhlový  
 GLAX profil, sarokba illeszthető  
 Profil de colț GLAX



	 L m		
PA-GLAXKT-AL	2	profil, profil, profil, profil	stříbrný, stříborný, ezüst, argintiu
PA-GLAXKT3M-AL	3		
PA-OSMLGLAX-00	2	kryt, kryt, takaró, dispersor	PC
PA-OSMLGLAX3M-00	3		
PA-OSTRGLAX-00	3		
PA-OSTRGLAX3M-00	2		
PA-ZASGLAXKT-00	-	koncovka, koncový kryt, végzáró, capac final	šedá, sivá, szürke, gri ABS

Kryty / Kryty / Takarók / Dispersoare:



PA-OSMLGLAX-00  
 PA-OSMLGLAX3M-00

PA-OSTRGLAX-00  
 PA-OSTRGLAX3M-00

Koncovka / Koncový kryt / Végzáró / Capac final:

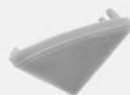

PA-ZASGLAXKT-00

Profil GLAX sklenný, vestavný  
 Profil GLAX uhlový, vstavaný  
 GLAX profil, sarokba illeszhető, süllyeszhető  
 Profil de colț încastat GLAX

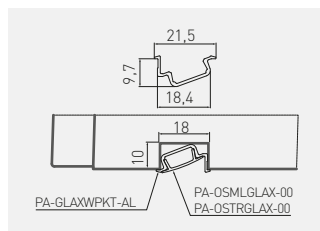

Vyzařovací úhel 22°  
 Uhol svietenia 22°  
 Sugárzási szög 22°  
 Unghiul fasciculului 22°



PA-GLAXWPKT-AL	2	profil, profil, profil, profil	stříbrný, stříborný, ezüst, argintiu	hliník, hliník, aluminium, aluminiu
PA-OSMLGLAX-00		kryt, kryt, takarók, dispensor	mléčná bílá, mliečna biela, tejfehér, alb mat	PC
PA-OSTRGLAX-00			průhledný, priehľadný, átlátszó, transparent	

Kryty / Kryty / Takarók / Dispersoare:



PA-OSMLGLAX-00



PA-OSTRGLAX-00

Profil GLAX vestavný  
 Profil GLAX vstavaný  
 GLAX profil, süllyesztett  
 GLAX încastrat - kit

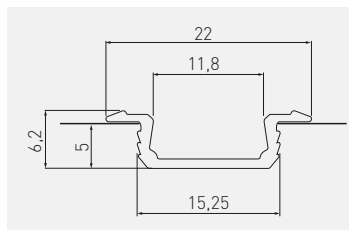

PA-ZGLAXOMZ-00	2	stříbrný, stříborný, ezüst, argintiu	hliník, PC matné, ABS; hliník, PC matné, ABS; aluminium, PC matt, ABS; aluminium, PC mat, ABS
PA-ZGLAXOMZ-20M		černá, čierna, fekete, negru	
PA-ZGLAXOMZ-10		bílám, biela, fehér, alb	

Profil GLAX přisazený mini  
 Profil GLAX povrchový mini  
 GLAX mini profil, falon kívül  
 Profil GLAX mini montat pe suprafață - kit

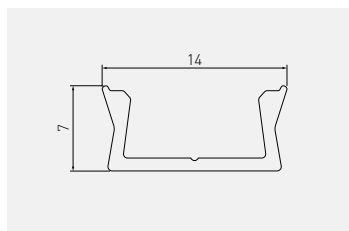

Úchytka / úchytka / rögzítő klipsz / dispozitiv de fixare:



PA-ZGLAXMNKOMZ-00	2	stříbrný, stříborný, ezüst, argintiu	hliník, PC matné, ABS; hliník, PC matné, ABS; aluminium, PC matt, ABS; aluminium, PC mat, ABS
PA-ZGLAXMNKOMZ-20M		černá, čierna, fekete, negru	
PA-ZGLAXMNKOMZ-10		bílám, biela, fehér, alb	

Profil GLAX sklopný  
 Profil GLAX uhlový  
 GLAX profil, sarkba illeszhető  
 Profil de colț GLAX - kit

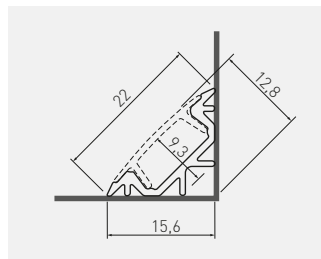

PA-ZGLAXKTMZ-00

2

stříbrný, stříborný, ezüst, argintiu

hliník, PC matné, ABS;  
 hliník, PC matné, ABS;  
 aluminium, PC matt, ABS;  
 aluminiu, PC mat, ABS

Profil GLAX sklopný, přisazený  
 Profil GLAX uhlový, povrchový  
 GLAX aluminium profil, sarkba illeszhető, falon kívüli  
 Profil de colț din aluminiu GLAX - montat aparent

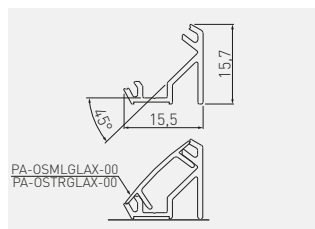

PA-ZGLAXNKKTMZ-20M

2

černá, čierna, fekete, negro

PA-ZGLAXNKKTMZ-10

bílám, biela, fehér, alb

hliník, PC matné, ABS;  
 hliník, PC matné, ABS;  
 aluminium, PC matt, ABS;  
 aluminiu, PC mat, ABS

Svítidlo, povrchová montáž/zapuštěné  
Svietidlo, povrchová montáž/zapustené  
Falon kívüli/süllyesztett lámpatest  
Corp de iluminat cu montaj aparent/încastat

## VASCO

360°

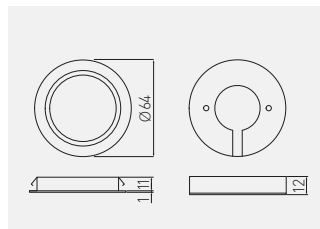

LD-VA24CB-53	130 lm	● 3000 K	hliník, hliník, aluminium, aluminiu	plast, plast, műanyag, plastic
LD-VA24NE-53		● 4000 K		



LED svítidlo  
LED svietidlo  
LED lámpatest  
Corp de iluminat LED

## LUMINO

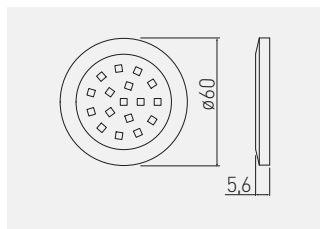

LD-LU16CB-53	85 lm	● 2700 K	hliník, hliník, aluminium, aluminiu	plast, plast, műanyag, plastic
LD-LU16NE-53		● 4000 K		
LD-LU16ZB-53		● 6500 K		





Svitidlo CASTELLO s vypínačom  
 Svietidlo CASTELLO s vypínačom  
 Lámpatest CASTELLO kapcsolóval  
 Spot CASTELLO cu comutator

## CASTELLO

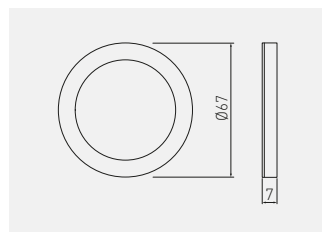

LD-CS36CB-53	180 lm	● 3000 K	hliník, hliník, aluminium, aluminium	plast, plast, műanyag, plastic
LD-CS36NE-53		● 4000 K		
LD-CS36ZB-53		● 6200 K		



Zapuštěné LED svítidlo  
Podomietkové LED svetidlo  
Süllyesztett LED lámpatest  
Corp de iluminat LED încastrat

## ALVARO

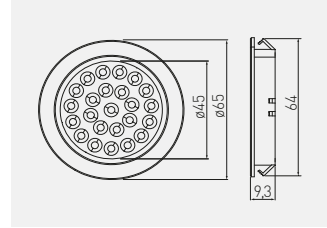

LD-AL24CB-53	130 lm	3000 K	hliník, hliník, aluminium, aluminu	plast, plast, műanyag, plastic
LD-AL24NE-53		4000 K		
LD-AL24ZB-53		6400 K		



LED svítidlo  
LED svetidlo  
LED lámpatest  
Corp de iluminat LED

## VEGAS

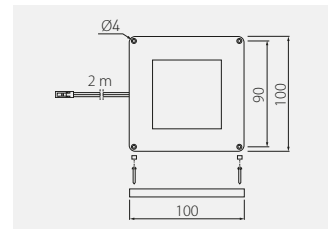

LD-VE15CB-53N	140 lm	3000 K	hliník, hliník, aluminium, aluminu	plast, hliník plast, hliník műanyag, aluminium plastic, aluminu
LD-VE15NE-53N	145 lm	4000 K		
LD-VE15ZB-53N	150 lm	6400 K		





Svítidlo 2 v 1  
Svietidlo 2 v 1  
2 az 1-ben lámpatest  
Corp de iluminat 2 în 1

## VEGAS



DUO - COL OR

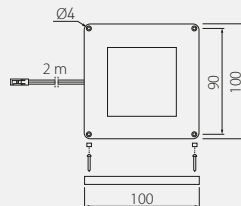

Související produkty:  
Bezdrátový bezdotykový spínač CCT  
AE-WDBP2CCT-10N, AE-WDBP2CCT-20N  
Súvisiace produkty:  
Bezdrátový bezdotykový spínač CCT  
AE-WDBP2CCT-10N, AE-WDBP2CCT-20N  
Kapcsolódó termékek:  
Vezeték nélküli érintés nélküli CCT kapcsoló  
AE-WDBP2CCT-10N, AE-WDBP2CCT-20N  
Produse conectabile:  
Comutator wireless fără atingere CCT  
AE-WDBP2CCT-10N, AE-WDBP2CCT-20N

LD-VE15CBZB-53N	140 lm	● 3000 K - ● 6400 K	hliník, hliník, aluminium, aluminium	plast, hliník plast, hliník műanyag, alumínium plastic, aluminium



LED svítidlo  
LED svietidlo  
LED lámpatest  
Corp de iluminat LED

## TREVI

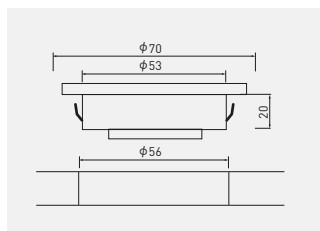

LD-TR24CB-53	300 lm	● 3000 K	hliník, hliník, aluminium, aluminium	plast, plast, műanyag, plastic
LD-TR24NE-53	220 lm	● 4000 K		
LD-TR24ZB-53	300 lm	● 6400 K		



Sada svítidel se spínačem  
Súprava svietidiel s vypínačom  
Kapcsolós lámpatest készlet  
Set de corpuri de iluminat cu comutator

## CASTELLO

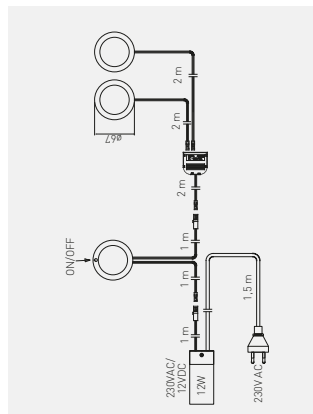

LD-Z3CSCB-53	3 x 180 lm	3000 K	hliník, hliník, aluminium, aluminiu	plast, plast, műanyag, plastic



Souprava svítidel  
Súprava svietidiel  
Lámpatest készlet  
Set corpuri de iluminat

## BARRI

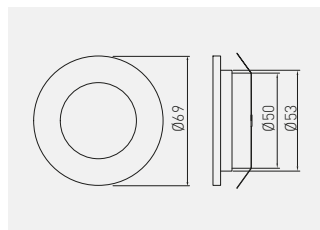

LD-0BP27CB-53	3 x 80 lm	2700 K	hliník, hliník, aluminium, aluminiu	plast, hliník plast, hliník műanyag, aluminium plastic, aluminium
LD-0BP27ZB-53		6400 K		



Souprava svítidel  
Súprava svietidiel  
Lámpatest készlet  
Set corpuri de iluminat

## MARBELLA

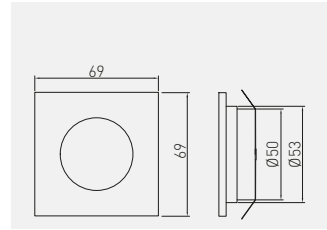

LD-KWP27CB-53	3 x 80 lm	2700 K	hliník, hliník, alumínium, aluminiu	plast, hliník plast, hliník műanyag, alumínium plastic, aluminiu



Svítidlo na konzole  
Svietidlo na ramene  
Karos lámpatest  
Corp de iluminat cu braț

## RADIUS II

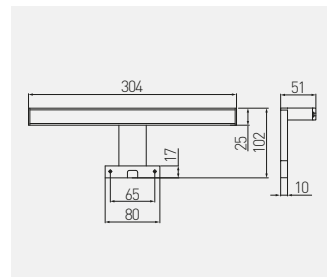

LD-RA60CB-40N	220 lm	3000 K	chrom, chróm, króm, crom	plast, plast, műanyag, plastic
LD-RA60ZB-40N		4000 K		



LED svítidlo bezvodičové  
Bezdrôtové LED svetidlo  
Vezeték nélküli LED lámpatest  
Corp de iluminat LED fără fir

## COMA



LD-IRUSB-53



LD-PIRUSB-53

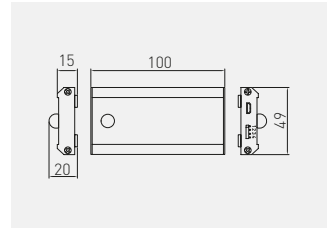

LD-IRUSB-53						
LD-PIRUSB-53	40-50 lm	● 4000 K	Infračervený snímač priblížení, jednopólový nebo dvoupólový, Infračervený snímač priblížení, jednopólový alebo dvojpólový, IR-közelségérzékelő, egy- vagy kétpólusú, Senzor de proximitate IR, unipolar sau bipolar		hliník, hliník, aluminium, aluminium	ocel, plast, ocel, plast, acél, műanyag, oțel, plastic



Lampička  
Lampa  
Lámpa  
Lampă

## BOSTON

360°

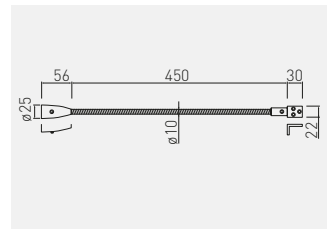

Vyžaduje napájecí zdroj 12 V, 6 W  
Výžaduje napájecí zdroj 12 V, 6 W  
12 V, 6 W tápegységre van szükség  
Necesită alimentare 12 V, 6 W

LD-BOS1CBWG-53	90 lm	● 3000 K	hliník, hliník, aluminium, aluminium			ocel, plast, hliník, ocel, plast, hliník, acél, műanyag, aluminium, oțel, plastic, aluminium



Plastový LED klip na poličky  
 Plastové LED klipsy na police  
 Műanyag LED polcvilágítás  
 Clemeș LED din plastic pentru rafturi

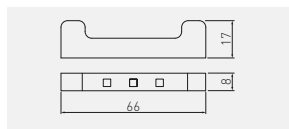
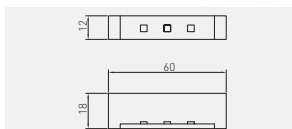

LD-KLPCB-00N

LD-KLPNB-00N

LD-KLPZB-00N

LD-3SKL-ZBN



LD-KLPCB-00N	10 lm	● 3000 K	plast, plast, műanyag, plastic
LD-KLPNB-00N	-	modrá, modrá, kék, albastru	
LD-KLPZB-00N	12 lm	● 6400 K	
LD-3SKL-ZBN	12 lm	● 6400 K	ocel, ocef, acél, oțel



LED transformátor EASY CLICK  
 LED transformátor EASY CLICK  
 LED tápegységek EASY CLICK  
 Surse de alimentare pentru LED EASY CLICK

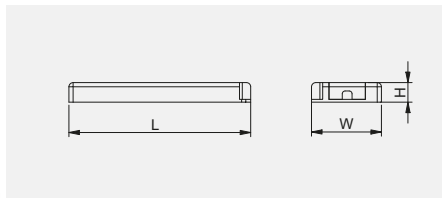





	max	i	A	LxWxH mm		
LD-ZAS09WEC-30	9 W	3 miniAMP	0,75 A	103 x 41 x 12mm	plast, plast, műanyag, plastic	110 g
LD-ZAS15WEC-30	15 W	4 miniAMP	1,25 A	129 x 42 x 16 mm		130 g
LD-ZAS20WEC-30	20 W		1,67 A	129 x 42 x 16 mm		140 g
LD-ZAS30WEC-30	30 W	6 miniAMP	2,5 A	160 x 50 x 18 mm		190 g
LD-ZAS60WEC-30	60 W		5 A	190 x 62 x 21 mm		290 g

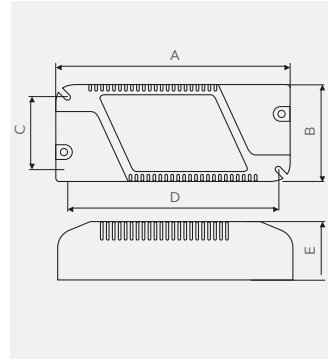

LED transformátor  
 LED transformátor  
 LED tápegységek  
 Surse de alimentare pentru LED







				
LD-ZAS75W-30	max 75 W	180 x 52 x 42 x 176 x 30	plast, plast, műanyag, plastic	350 g

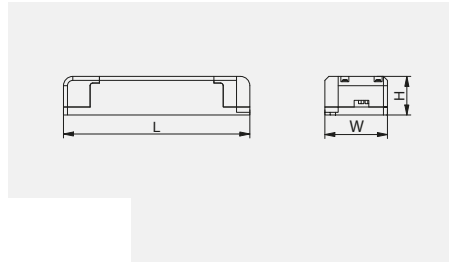

LED transformátor 24 V  
 LED transformátor 24 V  
 LED tápegységek 24 V  
 Surse de alimentare pentru LED 24 V



				
LD-ZAS24PRO80W-30	80 W	181 x 63 x 40 mm	plast, plast, műanyag, plastic	300 g
LD-ZAS24PRO16W-30	16 W			
LD-ZAS24PRO33W-30	33 W			
LD-ZAS24PRO54W-30	54 W			



Napájecí systém  
 Napájecí systém  
 LED tapegysegek  
 Surse de alimentare pentru



LD-ZZAS07PROKD6	7 W	100 x 39 x 25	plast, plast, műanyag, plastic
LD-ZZAS12PROKD6	12 W	120 x 42 x 27	
LD-ZZAS16PROKD6	16 W	120 x 42 x 27	
LD-ZZAS24PROKD6	24 W	140 x 47 x 29	
LD-ZZAS33PROKD6	33 W	155 x 53 x 30	

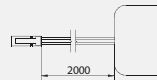
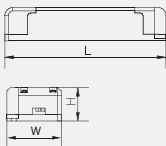

Napájecí zdroje LED PRO  
 Napájacie zdroje LED PRO  
 LED PRO tápegységek  
 Surse de alimentare pentru LED, PRO

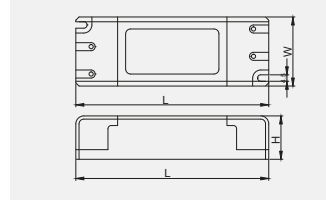

LD-ZASPRO07W-30	7 W	100 x 39 x 25 mm	plast, plast, műanyag, plastic	56g
LD-ZASPRO12W-30	12 W	120 x 42 x 27 mm		82 g
LD-ZASPRO16W-30	16 W	120 x 42 x 27 mm		82 g
LD-ZASPRO24W-30	24 W	140 x 47 x 29 mm		109 g
LD-ZASPRO33W-30	33 W	140 x 47 x 29 mm		150 g
LD-ZASPRO54W-30	54 W	155 x 53 x 30 mm		173 g
LD-ZASPRO65W-30	65 W	181 x 63 x 40 mm		281 g
LD-ZASPRO80W-30	80 W	181 x 63 x 40 mm		290g



LED transformátor  
 LED transformátor  
 LED tápegységek  
 Surse de alimentare pentru LED

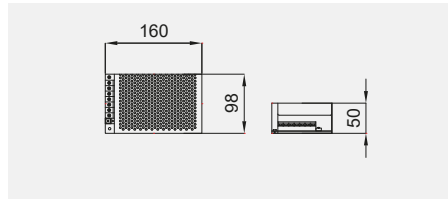

LD-ZAS150-NW	max 150 W	160 x 98 x 50	hliník, hliník, aluminium, aluminiu	347 g
--------------	-----------	---------------	-------------------------------------	-------





LED transformátor  
LED transformátor  
LED tápegységek  
Surse de alimentare pentru LED

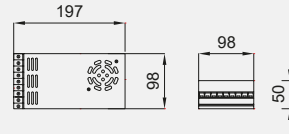

LD-ZAS350-NW	max 350 W	197 x 98 x 50	hliník, hliník, alumínium, aluminiu	589 g



LED transformátor  
LED transformátor  
LED tápegységek  
Surse de alimentare pentru LED



LD-WZA20W-NW	20 W	170 g
LD-WZA36W-NW	36 W	310 g
LD-WZA60W-NW	60 W	990 g
LD-WZA80W-NW	80 W	1000 g
LD-WZA150W-NW	150 W	2000 g

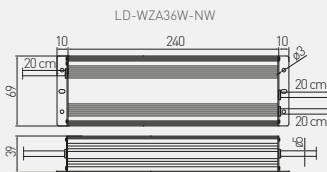
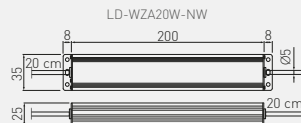
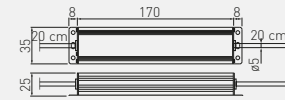
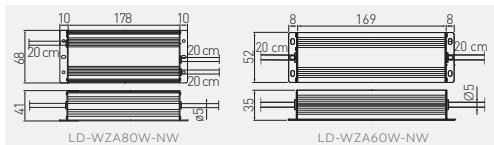

LD-WZA150W-NW



LED napájecí zdroj krabicový  
 Zdroj LED do krabice  
 Dobozos LED tápegység  
 Sursă de alimentare LED cutie

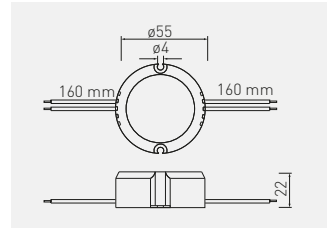

LD-ZASPU15W-30N	15 W	plast, plast, műanyag, plastic



Sada napájecího zdroje pro 5 LED klipů  
 Súprava napájacieho zdroja pre 5 LED klipov  
 Tápegység 5 LED klipszhez  
 Set alimentator pentru 5 clipsuri LED

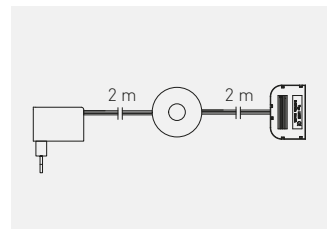

LD-ZSKL15-00N	5 x mini AMP	plast, plast, műanyag, plastic
LD-ZZASG18KWD6	6 x mini AMP	



LED transformátor  
LED transformátor  
LED tápegységek  
Surse de alimentare pentru LED

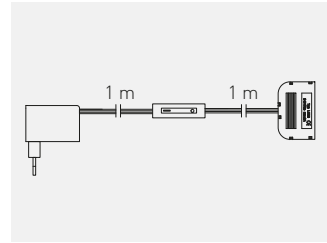

LD-ZWND6W-10	max 6 W	plast, plast, műanyag, plastic
LD-ZWND12-10	max 12 W	



Sada RGB – ovladač RGB, napájecí zdroj, dálkový ovladač a rozdělovač  
Súprava RGB – ovládač RGB, napájecí zdroj, diaľkový ovládač a rozdeľovač  
RGB készlet - RGB vezérlő, tápegység, távirányító és elosztó  
Kit RGB - controler RGB, sursă de alimentare, telecomandă și distribuitor

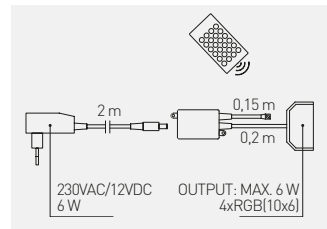

LD-ZAC6WDE-RGB	RGB	plast, plast, műanyag, plastic



Mini RGB dálkový ovladač  
 Mini RGB diaľkový ovládač  
 Mini RGB vezérlő távirányítóval  
 Mini controller RGB cu telecomandă

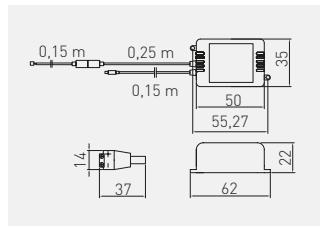

LD-KONMINI-RGB



RGB

plast, plast, műanyag, plastic

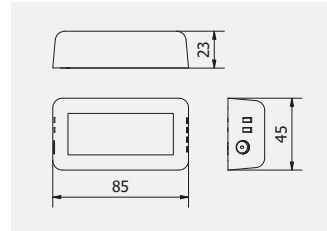

1zónový ovladač MONO  
 1-zónový ovládač MONO  
 1 zónás MONO vezérlő  
 Controller cu 1 zonă MONO



		
LD-KONML-MONO	MONO	plast, plast, műanyag, plastic



4zónový dálkový ovladač MONO  
 4-zónový diaľkový ovládač MONO  
 4 zónás távirányító MONO  
 Telecomandă cu 4 zone MONO

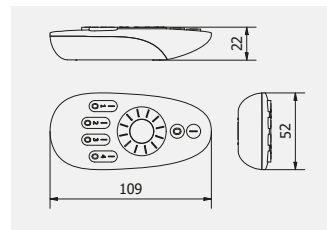

	
LD-KONML-MONO-PIL	plast, plast, műanyag, plastic



Bateriově napájený 4zónový dotykový panel MONO  
 Batériami napájaný 4-zónový dotykový panel MONO  
 Akkumulátoros 4 zónás érintőképernyő MONO  
 Panou tactil cu 4 zone, alimentat cu baterie MONO

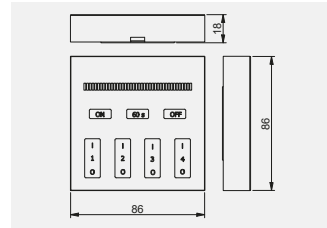

LD-KONML-MONO-PAN

plast, plast, műanyag, plastic



1zónový ovladač RGBW  
 1-zónový ovládač RGBW  
 1 zónás RGBW vezérlő  
 Controller cu 1 zonă RGBW

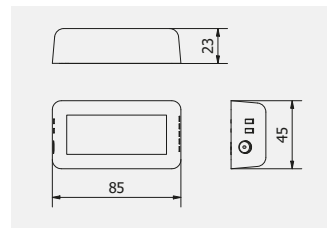

LD-KONML-RGBW



RGBW

plast, plast, műanyag, plastic

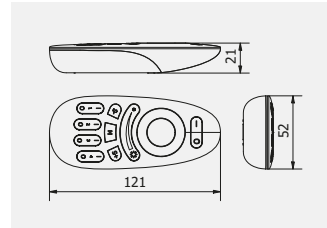

4zónový dálkový ovladač RGBW  
 4-zónový diaľkový ovládač RGBW  
 4 zónás távirányító RGBW  
 Telecomandă cu 4 zone RGBW





		
LD-KONML-RGBW-PIL	RGBW	plast, plast, műanyag, plastic

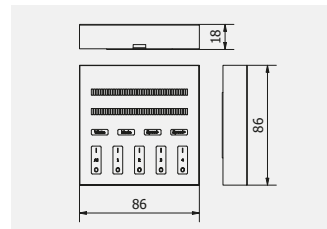

Bateriově napájený 4zónový dotykový panel RGBW  
 Batériami napájaný 4-zónový dotykový panel RGBW  
 Akkumulátoros 4 zónás érintőképernyő RGBW  
 Panou tactil cu 4 zone, alimentat cu baterie RGBW





		
LD-KONML-WRGB-PAN	RGBW	plast, plast, műanyag, plastic

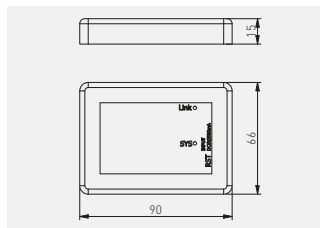

WiFi ovladač  
Wi-Fi ovládač  
WiFi-vezérlő  
Controller WiFi



		
LD-KONML-WIFI	RGB	plast, plast, műanyag, plastic



Adaptér dálkového ovládání  
Adaptér diaľkového ovládania  
Távírányító adapter  
Adaptor pentru telecomandă

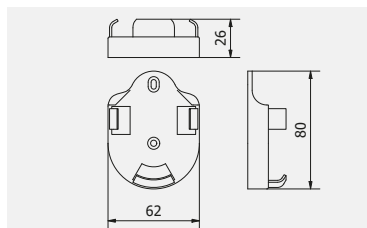

		
LD-KONML-AD	bílám, biela, fehér, alb	plast, plast, műanyag, plastic





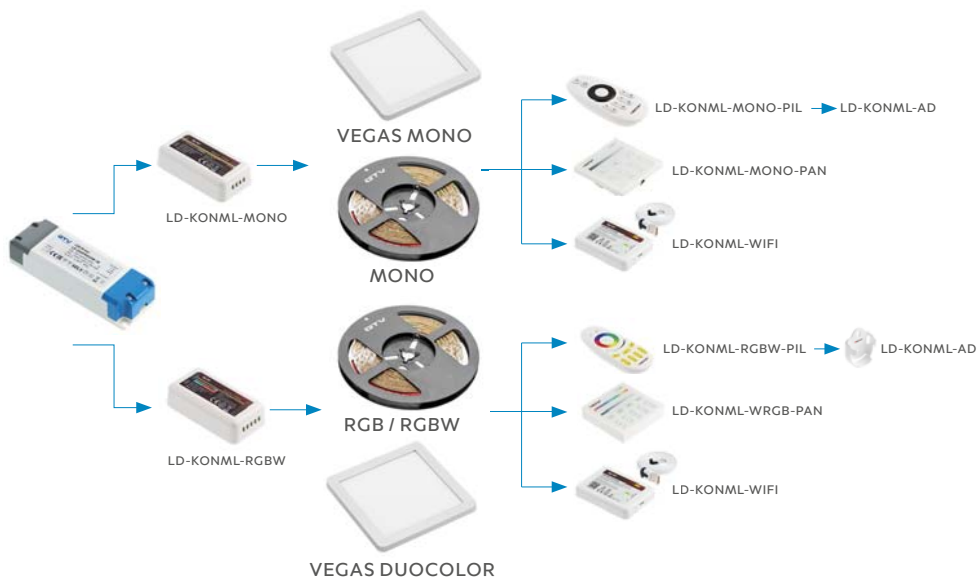

Bezdrátový bezdotykový spínač zapnutí-vypnutí  
 Bezdrôtový bezdotykový spínač zapnutia-vypnutia  
 Vezeték nélküli érintés nélküli ki-be kapcsoló  
 Comutator wireless fără atingere, pornire-oprire

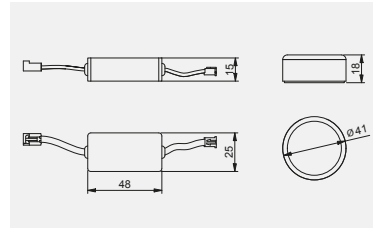

AE-WDBP1-10 N	bílám, biela, fehér, alb	plast, plast, műanyag, plastic
AE-WDBP1-20 N	černá, čierna, fekete, negru	



Bezdrátový bezdotykový spínač CCT  
 Bezdrôtový bezdotykový spínač CCT  
 Vezeték nélküli érintés nélküli CCT kapcsoló  
 Comutator wireless fără atingere CCT

NEW

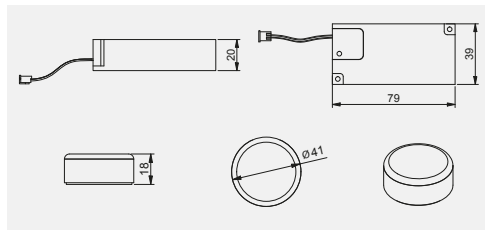

AE-WDBP2CCT-10N	bílám, biela, fehér, atb	plast, plast, műanyag, plastic
AE-WDBP2CCT-20N	černá, čierna, fekete, negru	





Bezdotykový spínač  
 Bezdotykový spínač  
 Érintés nélküli kapcsoló  
 Comutator fără atingere

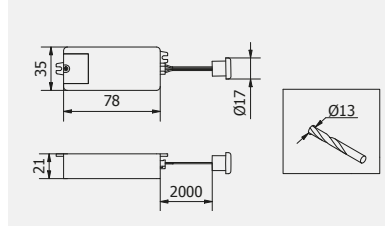

AE-WBEZDC-10S	dvoupólový, dvojpólový, kétpólusú, bipolar	plast, plast, műanyag, plastic
AE-WBEZDB-10S*	jednopolový, jednopólový, egypólusú, unipolar	



Dotykový spínač na šroub  
 Dotykový spínač na skrutku  
 Csavar alá szerelhető érintő kapcsoló  
 Comutatorul sub șurub cu atingere

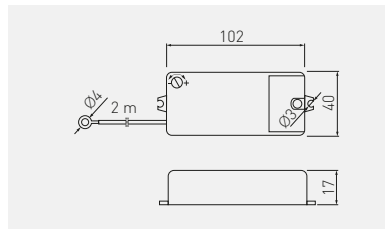

AE-WBEZDK15-10	plast, plast, műanyag, plastic	



Spínač s PIR detektorem pohybu  
 Vypínač s PIR detektorem pohybu  
 PIR mozgásérzékelős kapcsoló  
 Comutator cu detector de mișcare PIR

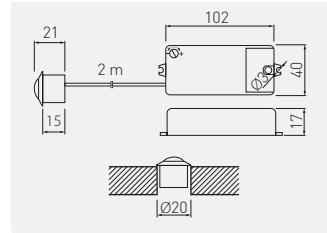

AE-WBEZDPIR-10	plast, plast, műanyag, plastic



Přepínač se dvěma snímači pohybu PIR II  
 Vypínač s dvoma PIR II snímačmi pohybu  
 Két PIR II mozgásérzékelős kapcsoló  
 Comutator cu doi senzori de mișcare PIR II

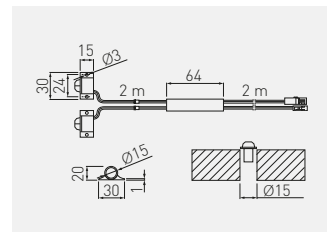

AE-WBEZDPIR2-20	plast, plast, műanyag, plastic



Univerzální bezdotykový spínač 3 v 1  
 Univerzálny bezdotykový spínač 3 v 1  
 3 az 1-ben univerzális érintés nélküli kapcsoló  
 Comutator multifuncțional, 3 în 1

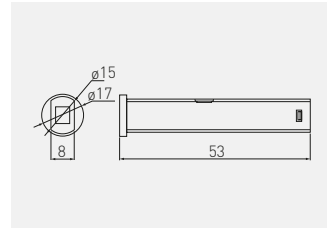

AE-WBBUNI-10DIM	bílám, biela, fehé, alb	plast, plast, műanyag, plastic
AE-WBCUNI-10DIM	černá, čierna, fekete, negru	



Bezkontaktní spínač, mikro  
 Bezkontaktný spínač, mikro  
 Érintésmentes kapcsoló, mikro  
 Comutator fără contact, micro

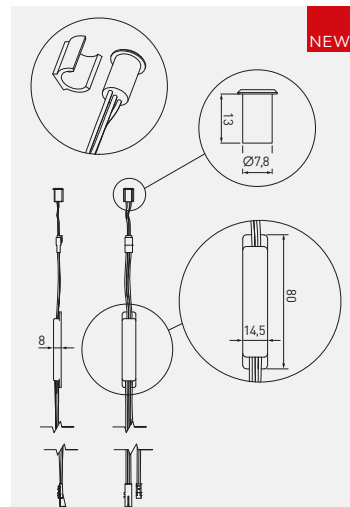

AE-WBE1-20	černá, čierna, fekete, negru	plast, plast, műanyag, plastic
AE-WBE1-10	bílám, biela, fehé, alb	



Bezkontaktní spínač, mikro  
 Bezkontaktný spínač, mikro  
 Érintésmentes kapcsoló, mikro  
 Comutator fără contact, micro

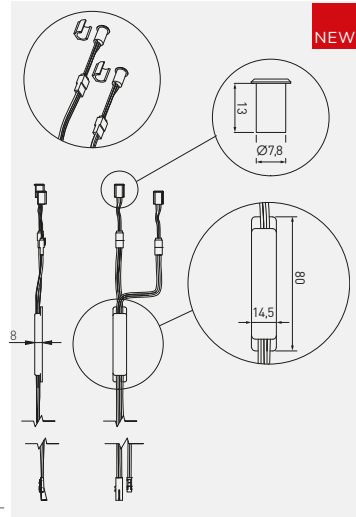

AE-WBE2-20	černá, čierna, fekete, negru	plast, plast, műanyag, plastic
AE-WBE2-10	bílám, biela, fehé, alb	



Stmívatelný dotykový spínač  
 Stmievateľný dotykový spínač  
 Dimmelő érintőkapcsoló  
 Comutator tactil pentru dimare

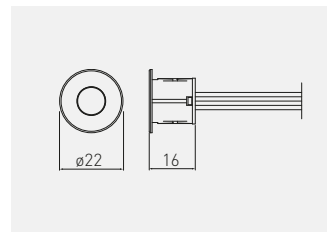

AE-WDSB-10DIM	bílám, biela, fehé, alb	plast, plast, műanyag, plastic
AE-WDSC-10DIM	černá, čierna, fekete, negru	



Stmívatelný dotykový spínač  
 Stmievateľný dotykový spínač  
 Dimmelő érintőkapcsoló  
 Comutator tactil pentru dimare

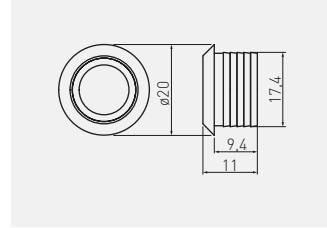

AE-WBEZD-NBN

chrom, chróm, króm,  
 crom

plast, plast, műanyag, plastic



Spínač pod pracovní desky  
 Spínač pod pracovné dosky  
 Pultba szerelhető érintőkapcsoló  
 Comutator sub blat fără atingere

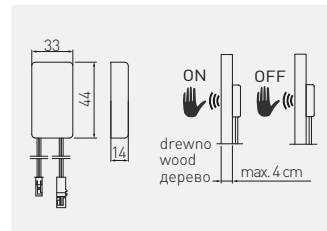

Tloušťka pracovní desky max. 40 mm  
 Hrubka pracovnej dosky max. 40 mm  
 A munkalap vastagsága max. 40 mm  
 Grosimea blatului maxim 40 mm



AE-WPDRW-00

plast, plast, műanyag, plastic





Spínač pro LED pásy namontované v profilu  
 Spínač pre LED pásiky namontované v profile  
 Profilba szerelhető kapcsoló LED-szalagokhoz  
 Comutator pentru benzi LED cu montate în profil

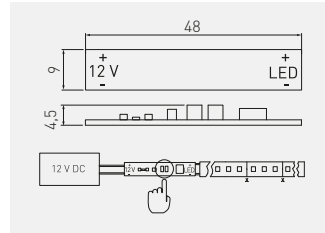

AE-WLPR-60	-	bílám, biela, fehér, alb	deska plošných spojů, doska plošných spojov, NYÁK lap, placă de circuit	1000
AE-WLPR-60P2	2 m			500



Kolébkový spínač  
 Kolískový spínač  
 Billenőkapcsoló  
 Buton comutator

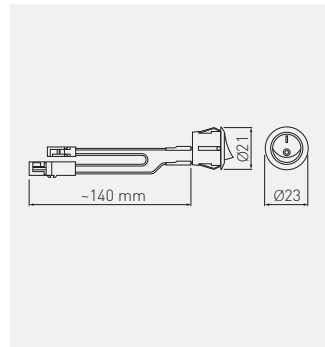



AE-WLB01-10	bílám, biela, fehér, alb	plast, plast, műanyag, plastic
AE-WLC01-20	černá, čierna, feketé, negru	



Kulatý kolébkový spínač  
 Okrúhly kolískový spínač  
 Kerek billenőkapcsoló  
 Comutator rotund



		
AE-WLIP44-15	bílám, biela, fehér, alb	plast, plast, műanyag, plastic



LED stmívač  
 LED stmievač  
 LED dimmer  
 Dimmer LED

JACKY

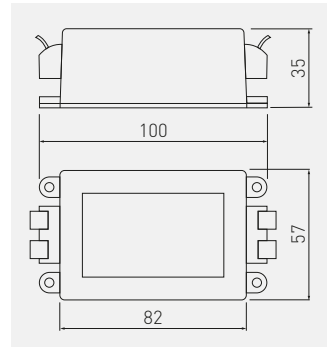

			
LD-DIMLED-10	černá, čierna, fekete, negru	PC	800 g



Vypínač šňůrkový  
 Vypínač, šňůrkový  
 Húzókapcsoló  
 Comutator cu lanț

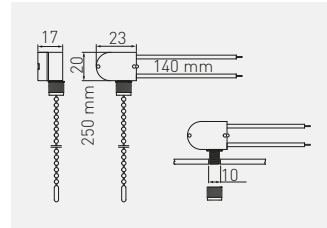

AE-WLLAN1-10	chrom, chróm, króm, crom	plast, plast, műanyag, plastic
AE-WLLAN1-90	zlatá, zlatá, Arany, auriu	
AE-WLLAN1-20	černá, čierna, fekete, negru	



Vypínač šňůrkový  
 Vypínač šňůrkový  
 Húzzókapcsoló, kábelle szerelhető  
 Comutator cu șnur pentru cablu



AE-WLSZN1-10	černá, čierna, fekete, negru	polypropylen, polypropylén, polipropilén, polipropilenă
--------------	------------------------------	---



Kabel se zástrčkou a vypínačem  
 Kábel so zástrčkou a vypínačom  
 Dugvillával és kapcsolóval ellátott vezeték  
 Cablu cu conector și comutator

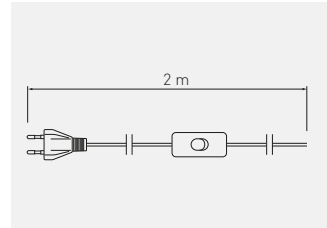

		
LD-KABE2M-00	bílám, biela, fehér, alb	plast, plast, műanyag, plastic



Kabel s Mini AMP  
 Kábel s Mini AMP  
 Kábel Mini AMP csatlakozóval  
 Cablu cu Mini AMP

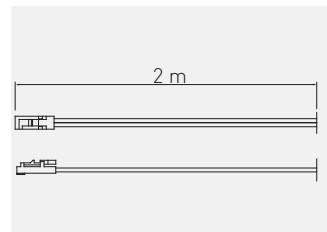



		
LZ-KA2MM-10	černá, čierna, fekete, negru	plast, plast, műanyag, plastic

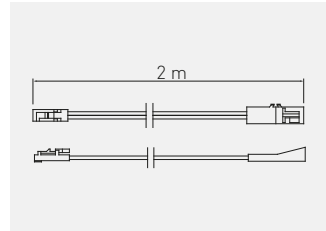

Kabel s Mini AMP  
 Kábel s Mini AMP  
 Kábel Mini AMP csatlakozóval  
 Cablu cu Mini AMP



		
LZ-KAPR2M-10	černá, čierna, fekete, negro	plast, plast, műanyag, plastic



Konektor pro LED svítidla s rozdělovačem, 3 zásuvky  
 Konektor pre LED svietidlá s rozdeľovačom, 3 zásuvky  
 Mini AMP elosztó LED lámpatestek csatlakoztatásához, 3 aljzat  
 Conector Mini AMP pentru corpuri de iluminat cu distribuitor, 3 prize

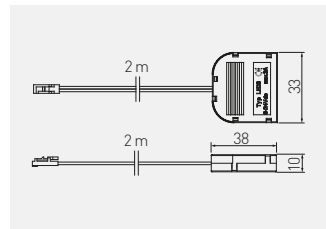

		
LZ-AKZ312-10N	černá, čierna, fekete, negro	plast, plast, műanyag, plastic



Konektor pro LED svítidla s rozdělovačem, 6 zásuvek  
 Konektor pre LED svietidlá s rozdeľovačom, 6 zásuviek  
 Mini AMP elosztó LED lámpatestek csatlakoztatásához, 6 aljzat  
 Conector Mini AMP pentru corpuri de iluminat cu distribuitor, 6 prize

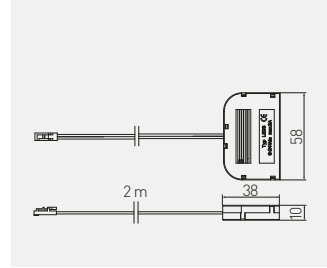

LZ-AKZ612-10N	černá, čierna, fekete, negro	plast, plast, műanyag, plastic



Uhlovy konektor pro LED pásy COB  
 Uhlovy konektor pre LED pásiky COB  
 Sarokcsatlakozo LED szalagokhoz COB  
 Conector unghiular pentru benzi LED COB

NEW

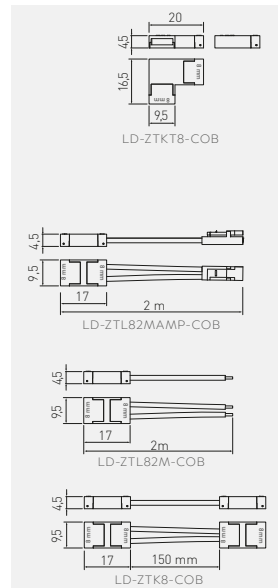
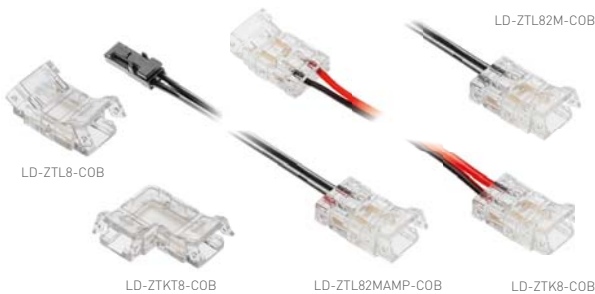

LD-ZTL82MAMP-COB	plast, plast, műanyag, plastic
LD-ZTL82M-COB	
LD-ZTL8-COB	
LD-ZTK8-COB	



Konektor XC11 pro LED pásky  
 Konektor XC11 pre LED pásiky  
 XC11 csatlakozó LED szalagokhoz  
 Conector XC11 pentru benzi LED



LD-ZTL8MM-02N600

LD-ZTL10MM-02N

LD-ZTLRGB-04N

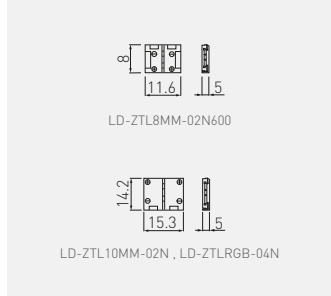

LD-ZTL8MM-02N600

LD-ZTL10MM-02N, LD-ZTLRGB-04N

LD-ZTL8MM-02N600	8 mm / 600 LED	plast, plast, műanyag, plastic	
LD-ZTL10MM-02N	10 mm		
LD-ZTLRGB-04N	RGB		



Úhlový konektor XC11 pro LED pásky  
 Uhlový konektor XC11 pre LED pásiky  
 XC11 sarokcsatlakozó LED szalagokhoz  
 Conector unghiular XC11 pentru benzi LED



LD-ZTKT8MM-02N600

LD-ZTKT10MM-02N

LD-ZTKTRGB-04N

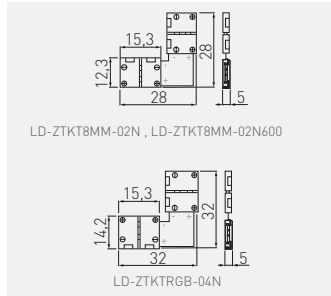

LD-ZTKT8MM-02N, LD-ZTKT8MM-02N600

LD-ZTKTRGB-04N

LD-ZTKT8MM-02N600	8 mm / 600 LED	plast, plast, műanyag, plastic	
LD-ZTKT10MM-02N	10 mm		
LD-ZTKTRGB-04N	RGB		



Konektor XC11 s 15 cm kabelem, na pásky  
 Konektor XC11 s 15 cm kábloom, na pásičky  
 XC11 csatlakozó 15 cm-es vezetékkel, LED szalagokhoz  
 Conector XC11 cu cablu de 15 cm, pentru benzi LED



LD-ZTK8MM-02N600 LD-ZTK10MM-02N

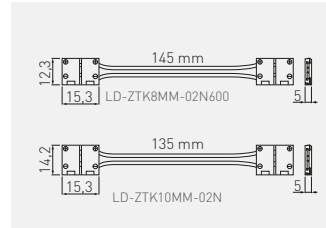

LD-ZTK8MM-02N600	8 mm / 600 LED	plast, plast, műanyag, plastic
LD-ZTK10MM-02N	10 mm	



Konektor XC11 pro LED pásky SLIM  
 Konektor XC11 pre LED pásičky SLIM  
 XC11 csatlakozó SLIM LED szalagokhoz  
 Conector XC11 pentru benzi LED SLIM



LD-ZTSL8MM-02N LD-ZTKS8MM-02N LD-ZTSL82M-2N LD-ZTSL8MMAMP-02N

LD-ZTSL8MM-02N	8 mm	-	plast, plast, műanyag, plastic
LD-ZTKS8MM-02N		15 cm	
LD-ZTSL82M-2N		200 cm	
LD-ZTSL8MMAMP-02N		200 cm + mini amp	

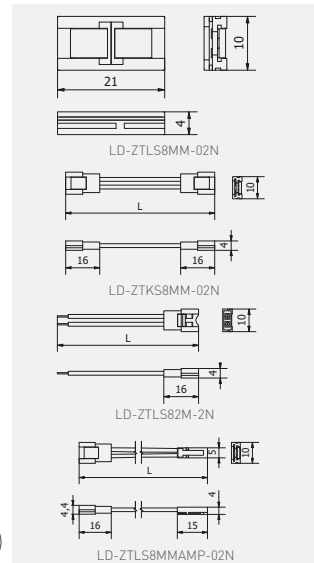



Bezdrátová nabíječka s napájením  
 Bezdrôtová nabíjačka s napájaním  
 Vezeték nélküli töltő tápegységgel  
 Încărcător wireless cu sursă de alimentare



360°

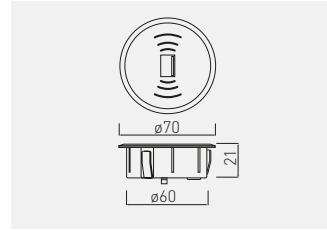

AE-ZUSB-20



černá, čierna, fekete, negro



plast, plast, műanyag, plastic



Indukční nabíječka s napájecím zdrojem LUX  
 Indukčná nabíjačka s napájacím zdrojom LUX  
 Induktív töltő LUX tápegységgel  
 Încărcător inductiv cu alimentare LUX

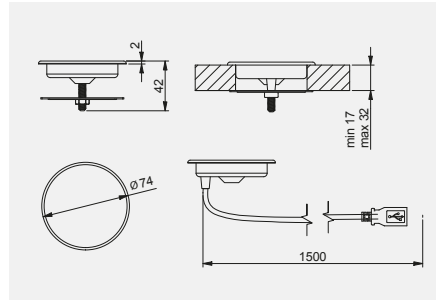

AE-ZLADLUX-40	chrom, chróm, króm, crom	plast, plast, műanyag, plastic



Bezdrátová povrchová nabíječka pod desku stolu  
 Bezdrôtová povrchová nabíjačka pod dosku stola  
 Vezeték nélküli töltő, a pult tetején  
 Încărcător de suprafață fără fir, cu instalație sub blat

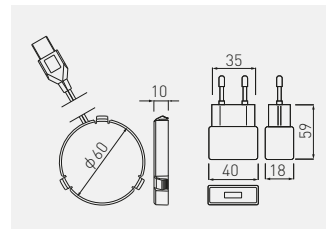

AE-ZLADPOD-20	černá, čierna, fekete, negro	plast, plast, műanyag, plastic





Zásuvkový blok zapuštěný  
Zásuvkový blok zapuštěný  
Süllyesztett bútorba építhető dugaljak  
Priză încastrată pentru mobilier



## PRESTINO

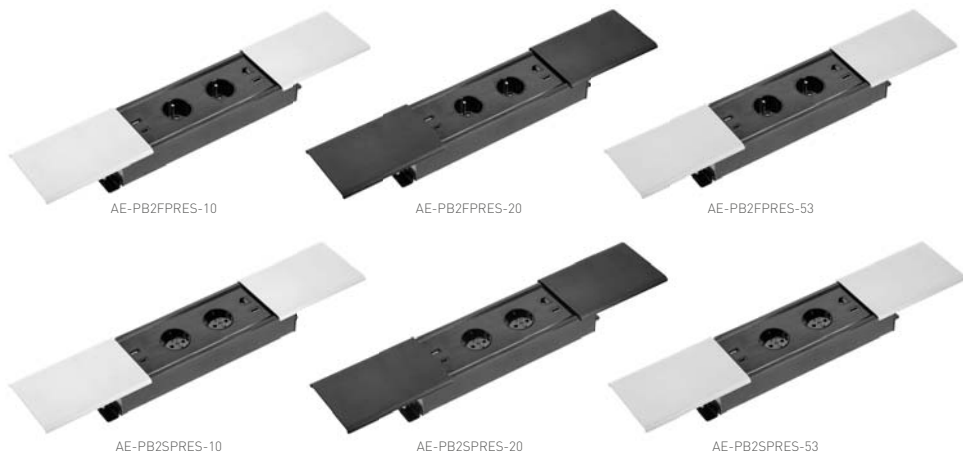

AE-PB2FPRES-20	USB-A + USB-C DC5V 3A (max 15,0W) DC9V 2A (MAX. 18,0W) DC12V 1.5A (MAX. 18,0W)	2 x french	hliník, hliník, aluminium, aluminiu	plast, hliník plast, hliník műanyag, aluminium plastic, aluminium	
AE-PB2SPRES-20		2 x schuko			
AE-PB2FPRES-53		2 x french			
AE-PB2SPRES-53		2 x schuko			
AE-PB2FPRES-10		2 x french			
AE-PB2SPRES-10		2 x schuko			

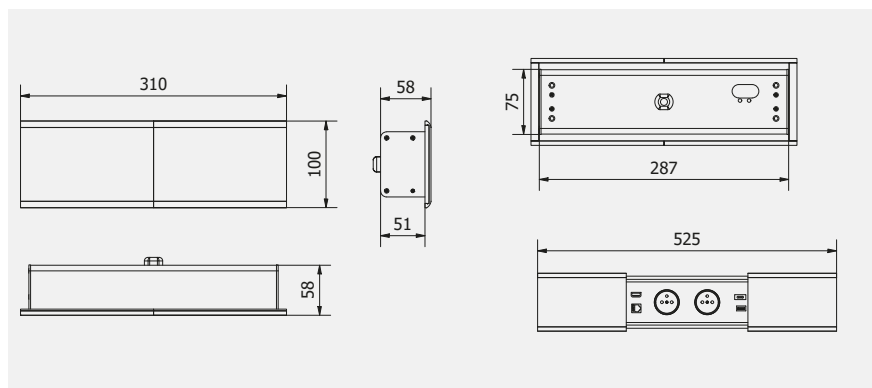

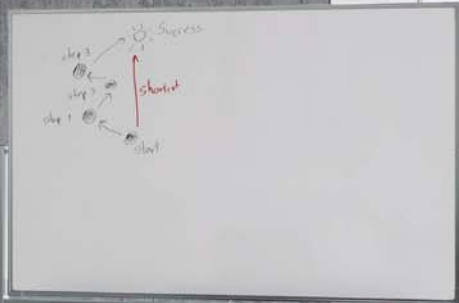

Zásuvkový blok zapuštěný  
Zásuvkový blok zapuštěný  
Süllyesztett bútorba építhető dugaljak  
Priză încastrată pentru mobilier



## CHARGER PLUS



AE-BPW1FACP-10



AE-BPW1SACP-10

AE-BPW1FACP-10	USB A+C 5V/2,4A interchangeable: USB A, HDMI, RJ45	1 x french	bílám, biela, fehér, alb	plast, plast, műanyag, plastic
AE-BPW1FACP-20		1 x french	černá, čierna, fekete, negro	
AE-BPW1SACP-10		1 x schuko	bílám, biela, fehér, alb	
AE-BPW1SACP-20		1 x schuko	černá, čierna, fekete, negro	

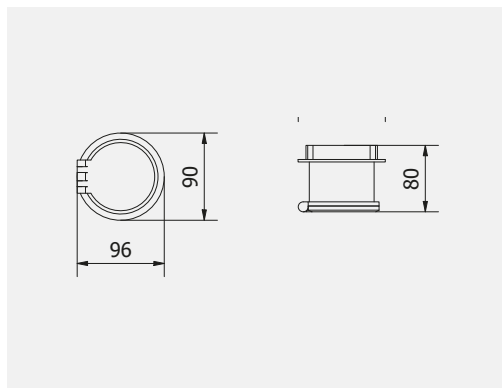

Included





Zásuvkový blok zapuštěný  
Zásuvkový blok zapuštěný  
Süllyesztett bútorba építhető dugaljak  
Priză încastrată pentru mobilier



## COMFORT PLUS



AE-BPW4F120P-10



AE-BPW4S120P-10

	i	X		
AE-BPW4F120P-10	2xUSB 5V/3,1A 2xRJ45	4 x french	bílám, biela, fehér, alb	plast. plast. műanyag, plastic
AE-BPW4F120P-20			černá, čierna, fekete, negro	
AE-BPW4S120P-10		4 x schuko	bílám, biela, fehér, alb	
AE-BPW4S120P-20			černá, čierna, fekete, negro	

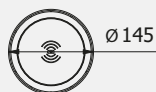
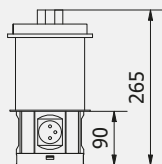





Zásuvkový blok zapuštěný  
 Zásuvkový blok zapuštěný  
 Súlylesztett bútorba építhető dugaljak  
 Priză încastrată pentru mobilier



## CAMINO



AE-BPW2FCAM-20



AE-BPW2FCAM-10

AE-BPW2FCAM-20	USB-A + USB-C DC5V 3A (max 15,0W) DC9V 2A (MAX. 18,0W) DC12V 1.5A (MAX. 18,0W)	2 x french	černá, čierna, fekete, negro	plast, hliník plast, hliník műanyag, alumínium plastic, aluminium
AE-BPW2SCAM-20		2 x schuko		
AE-BPW2FCAM-10		2 x french	bílám, biela, fehér, alb	
AE-BPW2SCAM-10		2 x schuko		

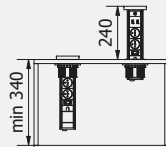
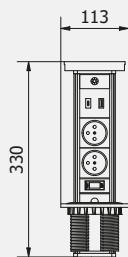



Zásuvkový blok zapuštěný  
Zásuvkový blok zapuštěný  
Súlylesztett bútorba építhető dugaljak  
Priză încastrată pentru mobilier



## AVARO PLUS



AE-PB1FAVAP-10



AE-PB1SAVAP-10

AE-PB1FAVAP-20	USB-A + USB-C DC5V 3A (max 15,0W) DC9V 2A (MAX. 18,0W) DC12V 1.5A (MAX. 18,0W)	1 x french	černá, čierna, fekete, negro	plast, hliník plast, hliník műanyag, alumínium plastic, aluminiu
AE-PB1SAVAP-20		1 x schuko		
AE-PB1FAVAP-53		1 x french	šedá, sivá, szürke, gri	
AE-PB1SAVAP-53		1 x schuko		
AE-PB1FAVAP-10		1 x french	bílám, biela, fehér, alb	
AE-PB1SAVAP-10		1 x schuko		

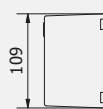
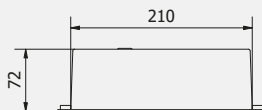
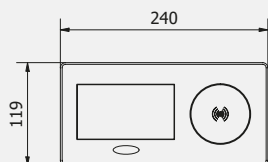



Zásuvkový blok zapuštěný  
Zásuvkový blok zapustený  
Süllyesztett bútorba építhető dugaljak  
Priză încastrată pentru mobilier



## AVARO



AE-PB1FAVA-10



AE-PB1SAVA-10



AE-PB1FAVA-20	USB A DC5V 2A (MAX. 10,0W)	1 x french	černá, čierna, fekete, negro	plast, hliník plast, hliník műanyag, alumínium plastic, aluminium
AE-PB1SAVA-20		1 x schuko		
AE-PB1FAVA-53		1 x french	šedá, sivá, szürke, gri	
AE-PB1SAVA-53		1 x schuko		
AE-PB1FAVA-10		1 x french	bílám, biela, fehér, alb	
AE-PB1SAVA-10		1 x schuko		

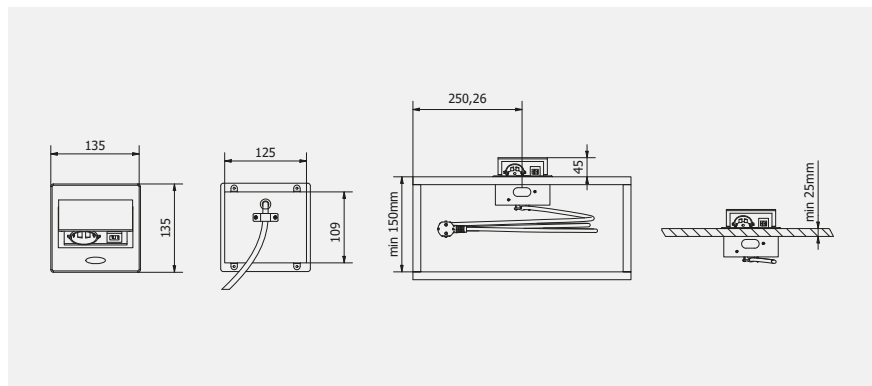



GTV  
LIGHTING

GTV  
LIGHTING

Zásuvkový blok zapuštěný  
Zásuvkový blok zapustený  
Süllyesztett bútorba építhető dugaljak  
Priză încastrată pentru mobilier

## CHARGER



AE-BPW1S2UCH-80

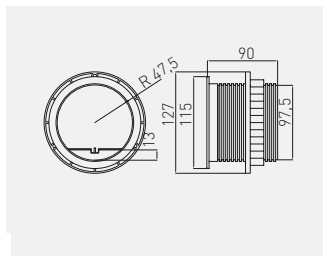

AE-BPW1S2UCH-80	1 x schuko	stříbrný, stříborný, ezüst, argintiu	plast, plast, műanyag, plastic
AE-BPW1U2UCH-80	1 x french		



Zásuvkový blok zapuštěný  
Zásuvkový blok zapustený  
Süllyesztett bútorba építhető dugaljak  
Priză încastrată pentru mobilier

## CHARGER MINI



AE-BPW1S1UCH-53

AE-BPW1U1UCH-53

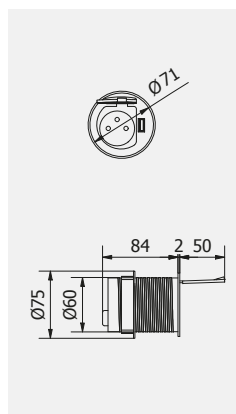

AE-BPW1U1UCH-53	1 x french	hliník, hliník, alumínium, aluminiu	plast, plast, műanyag, plastic
AE-BPW1S1UCH-53	1 x schuko		





Zásuvkový blok zapuštěný  
Zásuvkový blok zapuštěný  
Súlylesztett bútorba építhető dugaljak  
Priză încastrată pentru mobilier



## SLIDE



AE-BPW1U1UCH-51

AE-BPW1S1UCH-51

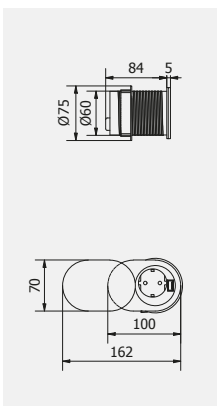

AE-BPW1U1UCH-51	USB 5V / 2,4A	1 x french	hliník, hliník, aluminium, aluminium	plast, plast, mŕanyag, plastic	
AE-BPW1S1UCH-51		1 x schuko			



Zásuvkový blok zapuštěný  
Zásuvkový blok zapuštěný  
Súlylesztett bútorba építhető dugaljak  
Priză încastrată pentru mobilier



## COMFORT



AE-BPW3S100U-53

AE-BPW4U100-53

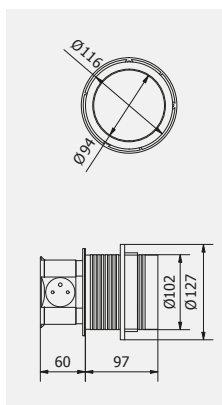

AE-BPW4U100-53	-	4 x french	hliník, hliník, aluminium, aluminium	plast, hliník plast, hliník mŕanyag, aluminium plastic, aluminium	
AE-BPW4S100-53		4 x schuko			
AE-BPW3U100U-53	USB 5V / 2,4A	3 x french			
AE-BPW3S100U-53		3 x schuko			



Zásuvkový blok zapuštěný kulatý  $\varnothing$  100  
 Zásuvkový blok zapuštěný okrúhly  $\varnothing$  100  
 Süllyesztett kerek bútorba építhető dugaljakk  $\varnothing$  100  
 Priză încastrată pentru mobilier rotundă  $\varnothing$  100

360°



AE-BPW3GU-20

AE-BPW3GU-20	100	3 x french	černá, čierna, fekete, negro	plast, hliník plast, hliník műanyag, alumínium plastic, aluminium
AE-BPW3GU-80			stříbrný, strieborný, ezüst, argintiu	
AE-BPW3GS-20		3 x schuko	černá, čierna, fekete, negro	
AE-BPW3GS-80			stříbrný, strieborný, ezüst, argintiu	

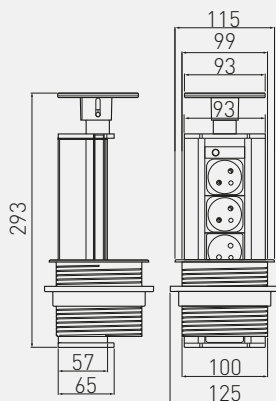



Zásuvkový blok zapuštěný kulatý ø 60  
 Zásuvkový blok zapuštěný okrúhly ø 60  
 Süllyesztett kerek bútorba építhető dugaljak ø 60  
 Priză încastrată pentru mobilier rotundă ø 60

360°



AE-BPW3U60-80

AE-BPW3U60U-20

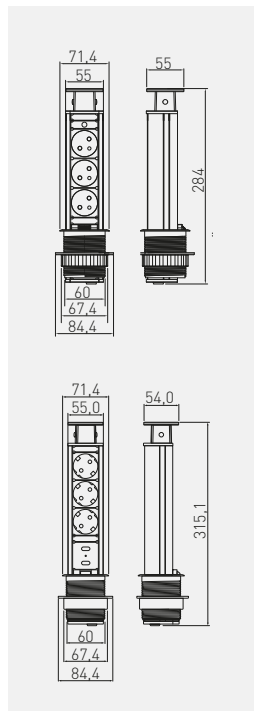

AE-BPW3U60-20	60	3 x french	-	černá, čierna, fekete, negro			
AE-BPW3U60-80				stříbrný, stříborný, ezüst, argintiu			
AE-BPW3S60-20		3 x schuko		černá, čierna, fekete, negro			
AE-BPW3S60-80				stříbrný, stříborný, ezüst, argintiu			
AE-BPW3U60U-20		5V USB		3 x french	černá, čierna, fekete, negro		
AE-BPW3U60U-80				stříbrný, stříborný, ezüst, argintiu			
AE-BPW3S60U-20				3 x schuko	černá, čierna, fekete, negro		
AE-BPW3S60U-80					stříbrný, stříborný, ezüst, argintiu		

plast, hliník  
 plast, hliník  
 műanyag, alumínium  
 plastic, aluminiu



Zásuvkový blok zapuštěný obdélníkový  
Zásuvkový blok zapuštěný obdĺžnikový  
Süllyesztett téglalap alakú bútorba építhető dugaljak  
Priză încastrată pentru mobilier dreptunghiulară



AE-PBC36U-20

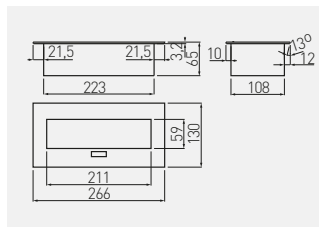

AE-PB03GS-53	-	3 x schuko	hliník, hliník, aluminium, aluminiu	ocel, plast, ocel, plast, ocel, múanyag, ořel, plastic
AE-PB03GS-20	-	3 x schuko		
AE-PB03GS-10	-	3 x schuko		
AE-PB03GU-53	-	3 x french		
AE-PBC36U-53	1,5 m	3 x french	černá, čierna, fekete, negro	
AE-PBC36U-10	1,5 m	3 x french	bílám, biela, fehéř, alb	



Zásuvkový blok zapuštěný obdélníkový  
Zásuvkový blok zapuštěný obdĺžnikový  
Süllyesztett téglalap alakú bútorba építhető dugaljak  
Priză încastrată pentru mobilier dreptunghiulară



AE-PBU2GU-10

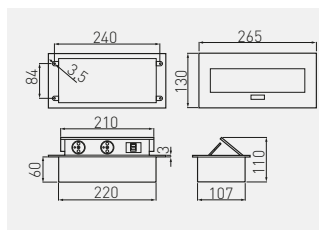

AE-PBU02GS-10	2 x schuko	bílám, biela, fehéř, alb	
AE-PBU02GS-20		černá, čierna, fekete, negro	
AE-PBU2GU-10	2 x french	bílám, biela, fehéř, alb	
AE-PBU2GU-20		černá, čierna, fekete, negro	
AE-PBU2GU-53		hliník, hliník, aluminium, aluminiu	



Zásuvkový blok zapuštěný  
Zásuvkový blok zapuštěný  
Süllyesztett bútorba építhető dugaljak  
Priză încastrată pentru mobilier



360°



## SOFT



AE-PBSC3GS-20



AE-PBSC3GS-53



AE-PBSUC2GS-20



AE-PBSUC2GS-53



AE-PBSC3GS-10	3 x schuko	-	bílám, biela, fehér, alb	ocel, plast, ocel, plast, acél, műanyag, oțel, plastic
AE-PBSC3GS-20N			černá, čierna, fekete, negru	
AE-PBSC3GS-53			hliník, hliník, alumínium, aluminiu	
AE-PBSC3GU-10	3 x french	-	bílám, biela, fehér, alb	
AE-PBSC3GU-20N			černá, čierna, fekete, negru	
AE-PBSC3GU-53			hliník, hliník, alumínium, aluminiu	
AE-PBSUC2GS-10	2 x schuko	5V USB max 2A	bílám, biela, fehér, alb	
AE-PBSUC2GS-20N			černá, čierna, fekete, negru	
AE-PBSUC2GS-53			hliník, hliník, alumínium, aluminiu	
AE-PBSUC2GU-10	2 x french		-	
AE-PBSUC2GU-20N				černá, čierna, fekete, negru
AE-PBSUC2GU-53				hliník, hliník, alumínium, aluminiu

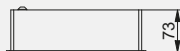



Zásuvkový blok zapuštěný s USB  
 Zásuvkový blok zapuštěný s USB  
 Áthaladó bútorba építhető dugaljak USB-vel  
 Priză pentru mobilier de treceare cu USB

360°



AE-PBC3GS-53BKS

AE-PBC3GS2U-53BKS

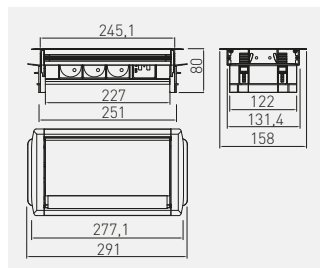

AE-PBC3GS-53BKS	3 x schuko	-	hliník, hliník, aluminium, aluminiu	plast, hliník plast, hliník műanyag, aluminium plastic, aluminiu	
AE-PBC3GS2U-53BKS	3 x schuko	5V USB max 2A			



Nábytková zásuvka bez pouzdra  
 Nábytková zásuvka bez púzdra  
 Beépítő keret nélküli bútorba építhető dugaljak  
 Priză pentru mobilier fără carcasă



360°



AE-PBC3GS-51BK

AE-PBC3GU-51BK

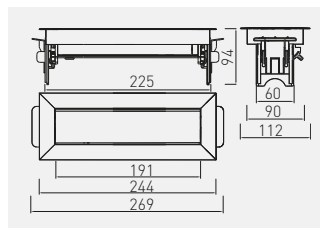

AE-PBC3GS-51BK	3 x schuko	kartáčovaná oceľ, kartáčovaná oceľ, szálcsiszolt acél, oțel periat	oceľ, hliník, plast, oceľ, hliník, plast, acél, aluminium, műanyag oțel, aluminiu, plastic	
AE-PBC3GU-51BK	3 x french			









Úhlová nábytková zásuvka  
 Uhlavá nábytková zásuvka  
 Sarokba illeszthető hosszabbító  
 Priză unghiulară pentru mobilier









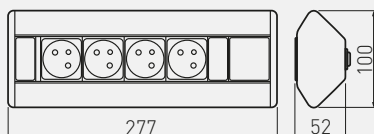



































AE-PBKT4S-80

AE-PBKT3U2U-80













































				
AE-PBKT4U-80	4 x french	-	stříbrný, stříborný, ezüst, argintiu	plast, hliník plast, hliník műanyag, alumínium plastic, aluminium
AE-PBKT4S-80	4 x schuko			
AE-PBKT3U2U-80	3 x french	5V USB max 2A		
AE-PBKT3S2U-80	3 x schuko			



# VYSVĚTLENÍ IKON / VYSVETLENIE IKON / IKONOK MAGYARÁZATA / EXPLICAȚIA PICTOGRAMELOR

	index index index		šířka šířka szélesség lățimea		doplňující informace doplnujúce informácie további információ informatii suplimentare
	výška vedení výška vedenia vezeto magasság înălțimea de ghidare		rozměry (mm) rozmary (mm) méretek (mm) dimensiuni (mm)		stupeň krytí IP trieda ochrany IP IP védettségi osztály grad de protecție IP
	vruty do dřeva skrutky do dřeva facșavarok șuruburi pentru lemn		rozměry (m) rozmary (m) méretek (m) dimensiuni (m)		řezná vzdálenost rezná vzdialenost vágási távolság distanța de taiere
	euro šrouby euro skrutky euro csavarok șuruburi euro		tloušťka hrúbka vastagság grosime		šířka pásky šířka pásika csíkszélesség lățimea benzii
	povrchová úprava povrchová úprava feület nisare		Hloubka Hĺbka a szekrény külső szélessége lățimea exterioră a dulapului		USB USB USB USB
	barva barba szín culoare		materiál materiál anyag material		typ zásuvky typ zásuvky alzat típusa tip soclu
	zátížení zataženie terhelés sarcină		výsuv výsuv kiterjesztés extensie		napájení napájanie teljesítmény putere
	objem objem kapacitás capacitate		tvar tvar alak formă	Nábytkové príslušenství Nábytkové doplnky Bútor kiegészítők Accesorii pentru mobilă	
	síla sila erősség putere		světelný tok svetelný tok fényáram ux luminous		naložená dvířka naložené dvierka ráhajló ajtó ușă suprapusă
	délka dĺžka hossz lungime		délka kabelu dĺžka kabla vezeték hossza lungimea cablului		polonaložená dvířka dvojité prekrytie íker fedvény semi aplicate
	velikost veľkosť méret mărire		počet diod počet diód diódák száma număr de diode		vložená dvířka vložené dvierka beillesztett ajtó incadrata
	výška výška magasság înălțime		barva skříně barba skrine ház színe culoarea carcasei		rohový záves rohový záves sarokpánt balama de colț
	ztráta výsuvu strata výsuvu kihúzás veszteség pierdere extensiei		teplota barvy teplota farby színhőmérséklet temperatura culorii		záves s velkým úhlem otevření šírokouhý záves széles szögű pánt balama cu unghi larg
	průměr priemer átmérő diametru		úhel paprsku uhol lúča sugárzási szög Unghiul fasciculului		paralelní záves paralelný záves Kivetőpánt balama paralelă
	* Uživatelsky přívětivé produkty Používateľsky prívetivé produkty Fogyasztóbarát termékek Produse ușor de folosit		*Výrobky GTV označené tímto symbolem podléhají pečlivé kontrole. Jejich speciálně vybrané materiálové složení splňuje některé z nej přísnějších ekologických směrnic. Konečný uživatel dostává bezpečný výrobek, jehož bezchybný provoz si bude užívat po mnoho let. Výrobky GTV označené tímto symbolem podléhajú dôkladnej kontrole. Ich špeciálne zostavené materiálové zloženie spĺňa niektoré z najprísnejších environmentálnych smerníc. Konečný používateľ dostáva bezpečný výrobok, ktorého bezchybnú prevádzku si bude užívať dlhé roky. Az ezzel a szimbólummal jelölt GTV termékek szigorú ellenőrzésen esnek át. Speciálisan kiválasztott anyagösszetételüknek köszönhetően megfelelnek az egyik legmagasabb környezetvédelmi irányelvnek. A végfelhasználó egy biztonságos terméket kap, amelynek problémamentes működése hosszú évekig élvezhető. Produsele GTV marcate cu acest simbol sunt supuse unei inspectii riguroase. Compoziția lor de material special selectată îi face să îndeplinească una dintre cele mai înalte reguli de mediu. Utilizatorul final primește un produs sigur de a căru funcționare fără probleme se va bucura mulți ani.		

FRIENDLY

	paralelný záves pro naložená dvířka paralelný záves pro naložené dvířka Kivetőpánt rázóród balama paralelá aplica		nasunovací montáž montáž nasunutím csuszatóz rögzítés montare prin glisare		push-to-open
	doplňkový záves doplňkový záves Kiegészítő kivetőpánt balama complementară		záves s pomalým zavíráním záves s pomalým zatváraním pánt csillapítással balama cu inchidere cu amortizare		plný výšuv úplný výšuv teljes kihúzás extensie completă
	nastavení nastavenie beállítás ajustare		záves s uzavírací pružinou záves s uzatváracou pružinou pánt zárórugóval balama cu arc de inchidere		standardní zásuvka standardná zásuvka standard fiók sertar standard
	jednočinný záves jednočinný záves egyhatású pánt balama cu acțiune unică		samozavírací záves samozaťvárací záves önnyíló pánt balama cu deschidere automată		zásuvka pod dřez zásuvka pod drez mosogató fiók alatt sertar sub chiuveta
	dvojitý záves dvojčinný záves kettős hatású pánt balama cu dublă acțiune		záves bez pružiny záves bez pružiny pánt rugó nélkül balama fără arc		rohová zásuvka rohová zásuvka sarokfiók sertar de colț
<b>SPECIAL</b>	speciální záves speciálny záves speciális pánt balama specialia		nízká zásuvka nízka zásuvka alacsony fiók sertar mic A		standardní zásuvka standardná zásuvka hagyományos fiók sertar standard
	Ø 35 mm průměr misky závěsu priemer misky závěsu pánt átmérője diametrul cupei balamalei		střední zásuvka stredná zásuvka közepes fiók sertar mediu		vnitřní zásuvka vnútorná zásuvka belső fiók sertar interior
	45 mm rozeč otvorů misky závěsu rozstup otvorov misky závěsu pánt furási távolság distanța de găurire a cupei balamalei		vysoká zásuvka magas zásuvka magas fiók sertar înalt		zásuvka se spodní montáží zásuvka so spodnou montážou fiók alatti szerelés montare sub sertar
	montáž misky závěsu pomocí vrutů do dřeva montáž misky závěsu pomocou skrutiek do dřeva facasvaroz rögzítés montare cușă balama șurub lemn		vertikální a horizontální nastavení vertikálne a horizontálne nastavenie függőleges és vízszintes beállítás reglare verticală și orizontală		kuličkový výšuv guľčkový výšuv Golyós fióksín glisiera cu bile
	instalace montážní desky pomocí vrutů do dřeva inštalácia montážnej dosky pomocou skrutiek do dřeva facasvaroz rögzítőlemez telepítése instalare placă de montare cu șurub pentru lemn		možnost uvolnění možnosť uvoľnenia kiadási lehetőség opțiunea de lansare		Euro válečkový výšuv Euro valčekový výšuv Euro görögös sín Glisiera cu role euroslide
	instalace montážní desky pomocí euro šroubů inštalácia montážnej dosky pomocou euro skrutiek euro csavaroz rögzítőlemez telepítése instalare placă de montare cu șurub euro		H=83 výška strany zásuvky MB Square výška strany zásuvky MB Square fiók oldalsó magassága MB négyzet înălțimea laterală a sertarului MB Square		Metalbox Metalbox Metalbox Metalbox
	montáž závěsu pomocí hmoždinek montáž závěsu pomocou rozper tipils pánt balama de montare cu diblu		H=83 výška strany zásuvky MB výška strany zásuvky MB fiók oldalmagasság MB înălțimea laterală a sertarului MB		SLOW tiché zavření tiché zatváranie csendesen záródó inchiderea cu amortizare
	excentrické nastavení excentrické nastavenie excentrikus beállítás reglare excentrică		H=95 výška strany zásuvky AXIS výška strany zásuvky AXIS fiók oldalmagasság AXIS înălțimea laterală a sertarului AXIS		SELF CLOSING samozavírací samozaťváracie önzáró inchiderea de sine
	x 100 balení balenie csomagolás ambalare		3D 3D model k dispozici 3D model k dispozícii 3D modell elérhető Model 3D disponibil		tláčná montáž se zajišťovacím zařízením montáž zatlačením so zaisťovacím zariadením tolószerezelés zárószekerezettel montare prin împingere cu dispozitiv de blocare
	CLIP-ON zaklapávací montáž montáž zaklapnutím klíppes rögzítés montare cu clip		CERTIFICATE 60.000 testovaná životnost testovány životnosť tesztelt tartósság durabilitate testată		nasazovací montáž montáž nasadením rátéve pus pe montaj

\* Pro stavební použití  
Pre stavebné použitie  
Építőipari alkalmazásokhoz  
Pentru aplicații în construcții

\*Všechny výrobky uvedené v katalogu jsou určeny pro nábytkové použití, pokud není na výrobku uvedeno jiné použití. Všetky výrobky uvedené v katalogu sú určené pre nábytkové použitie, pokiaľ nie je na výrobku uvedené iné použitie. A katalógusban szereplő összes termék bútornak vanotkozik, kivéve, ha a termékhez más alkalmazási területet jeleznek.

Toate produsele prezentate în catalog sunt destinate mobilierului, cu excepția cazului în care este indicată o altă aplicație pentru produs.



částečný výřev  
častočný výřev  
részleges kihúzás  
extense partjálá



maximální tloušťka desky  
maximálna hrúbka desky  
max. bútorlap vastagság  
grosimea maximá a blatului



vertikální nastavení  
vertikálne nastavenie  
függőleges beállítás  
reglare verticală



horizontální nastavení  
horizontálne nastavenie  
vízszintes beállítás  
reglare orizontálă



nastavení hloubky  
nastavenie hĺbky  
mélységbeállítás  
reglarea adâncimii



Pro sklo  
Pre sklo  
készülékűveg  
sticla aparatului



Pro 4 mm sklo  
Pre 4 mm sklo  
készülékűveg 4 mm  
sticla aparat 4 mm



Pro desku  
Pre dosku  
készülékpanel  
panoul aparatului



Pro 18 mm desku  
Pre 18 mm dosku  
bútorlap 18 mm  
blat 18 mm



Pro 12 mm desku  
Pre 12 mm dosku  
12 mm vastag bútorlaphoz  
Pentru blat 12 mm



Pro desku ≥ 16 mm  
Pre dosku ≥ 16 mm  
16 mm vastag bútorlaphoz  
Pentru blat 16 mm



Pro 10 mm desku  
Pre 10 mm dosku  
10 mm vastag bútorlaphoz  
Pentru blat 10 mm



panel spotřebiče ≥ 16 mm  
panel spotřebiča ≥ 16 mm  
bútorlap ≥ 16 mm  
blat ≥ 16 mm



Pro 16 - 22 mm desku  
Pre 16 - 22 mm dosku  
16 - 22 mm vastag bútorlaphoz  
Pentru blat 16 - 22 mm



Pro 16 - 28 mm desku  
Pre 16 - 28 mm dosku  
16 - 28 mm vastag bútorlaphoz  
Pentru blat 16 - 28 mm

## Osvětlení nábytku Osvetlenie nábytku Bútorvilágítás Iluminat mobilier



třída energetické účinnosti  
trieda energetickej účinnosti  
energiatahékonysági osztály  
clasa de eficiență energetică



Napájecí zdroj 220-240 V AC  
Napájaci zdroj 220-240 V AC  
220-240 V tápegység AC  
Alimentare 220-240 V AC



Napájecí zdroj 12 V DC  
Napájaci zdroj 12 V DC  
12 V tápegység DC  
Alimentare 12 V DC



Napájecí zdroj 12 V  
Napájaci zdroj 12 V  
12 V tápegység  
Alimentare de 12 V



výstupní napětí  
vystupné napätie  
kimeneti feszültség  
tensiunea de ieșire



výkon žárovky nebo svítidla  
výkon žiarovky alebo svietidla  
izzó vagy lámpatest teljesítménye  
puterea corpului de iluminat sau al becului



maximální přípustné zatížení  
maximálne prípustné zataženie  
legnagyobb megengedett terhelés  
sarcina maximă admisibilă



úhel paprsku  
uhol lúča  
sugárzási szög  
Unghiul fasciculului



typy diody  
typy diód  
diódatípusok  
tipuri de diode



počet diod  
počet diód  
diódák száma  
număr de diode



délka kabelu  
dĺžka kábla  
vezeték hossza  
lungimea cablului



délka kabelu se zástrčkou  
dĺžka kábla so zástrčkou  
kabel hossza dugóval  
lungimea cablului cu mufa



délka kabelu s konektorem  
dĺžka kábla s konektorem  
kabel hossza csatlakozóval  
lungimea cablului cu conector



Typ konektoru  
typ konektora  
csatlakozó típusa  
tipul de conector



Typ konektoru  
typ konektora  
csatlakozó típusa  
tipul de conector



Typ konektoru  
typ konektora  
csatlakozó típusa  
tipul de conector



stufen kryti IP  
trieda ochrany IP  
IP védettségi osztály  
grad de protecție IP



index zobrazování barev  
index zobrazovania farieb  
színesszaadási index  
index de redare a culorilor



účinník  
účinník  
teljesítménytényező  
factor de putere



spínací cyklus  
spínací cyklus  
kapcsolási ciklus  
ciclul de comutare



Stmivatelny dotykový spínač  
Stmivatelny dotykový spínač  
Dimmelhető érintőkapcsoló  
Comutator tactil reglabil



svítdilo s vypínačem  
svítdilo s vypínačom  
lámpatest kapcsolóval  
corp cu comutator



dálkové ovládání (IR/RF)  
dialkovoé ovládanie (IR/RF)  
távírányító (IR/RF)  
telecomandă (IR/RF)



dvoupólový bezdotykový spínač  
dvojpólóvóv bezdotykový spínač  
kétpólusú érintés nélküli kapcsoló  
comutator bipolar fără atingere



jednopolový bezdotykový spínač  
jedenpólóvóv bezdotykový spínač  
egypólusú érintés nélküli kapcsoló  
comutator unipolar fără atingere



rozsah snímače pohybu  
rozsah snímača pohybu  
mozgásérzékelő tartományja  
gama senzorului de mișcare



nominální životnost  
nominálna životnosť  
névleges élettartam  
durata de viață nominală



počáteční čas (max)  
počiatočný čas (max)  
kezdési idő (max)  
ora de pomire (max)



základní typ G4  
základný typ G4  
foglalat típus G4



pracovní teplota  
pracovná teplota  
üzemhőmérséklet  
temperatura de lucru



Port USB  
Port USB  
USB csatlakozó  
port USB



maximální zatížení USB portů  
maximálne zaťaženie USB portov  
max. USB portok betöltése  
porturi USB de încălzire maximă



Zásuvka pro Velkou Británii  
Zásuvka pre Velkú Britániu  
UK aljzat  
Soclu UK



ethernetový port  
ethernetový port  
Ethernet port  
port Ethernet



nestmivatelny  
nestmivatelny  
nem szabályozható  
nedimabil



stmivatelny  
stmivatelny  
tompítható  
reglabil



aplikace: vnitřní / stropní montáž  
aplikácia: vnútorná / stropná montáž  
alkalmazás: beltéri / mennyezetre szerelhető  
aplicație: montaj în interior / tavan



doporučená montážní vzdálenost od povrchů  
ajánlott szerelési távolság a felületektől  
distanța de montare recomandată fata de suprafețe



průměr montážního otvoru  
priemer montážneho otvoru  
rögiztő furat átmérője  
diametrul orificiului de montare



baterie  
batéria  
akkumulátor  
baterie



Maximální zatížení na kanál  
Maximálne zaťaženie na kanál  
Csatornánként maximális terhelés  
Sarcina maximă pe canal



Frekvence dálkového ovládání  
Frekvencia dialkovoého ovládania  
Távírányító frekvenciája  
Frecvența telecomenzii

Maximální ztrátový výkon žárovek pro profily zahřáté do 65 °C, pokud se použijí stínidla.

Maximálny stratový výkon žiaroviek pre profily zahriate do 65 °C, pokiaľ sa použijú tienidlá.

Maximálisan alkalmazható teljesítmény, ha 65°C-ig melegeđó profilit szeretnénk takarékelemmel ellátva.

Puterea maximă admisă, dacă dorim profile încălzite până la maxim 65°C, în cazul în care se folosește cu dispersor.\*



BARVA  
FARBA  
SZÍN  
CULOARE



10  
bílá  
biela  
fehér  
alb



80  
stříbrný  
strieborný  
ezüst  
argint



14  
starožitná měď  
starožitná med  
antik réz  
cupru antic



10M  
bílá matná  
biela matná  
fehér matt  
alb mat



7  
starožitné stříbro  
starožitné striebro  
antik ezüst  
argint antic



20  
černá  
čierna  
fekete  
negru



smetanová  
smotanová  
tej  
lapte



19  
šedá matná  
sivá matná  
szürke matt  
gri mat



20M  
černá matná  
čierna matná  
fekete matt  
negru mat



CS  
smetanová  
smotanová  
ekrú  
ecru



2, 52  
satén  
satén  
szatén  
satin



58  
venge  
venge  
venge  
venge



1, 40  
chrom  
chróm  
króm  
crom



6, 51  
kartáčovaná ocel  
kartáčovaná ocel  
szálcsiszolt acél  
oțel periat



3  
mosaz  
mosadz  
sárgaréz  
alamă



5, 53  
hliník  
hliník  
alumínium  
aluminiiu



11  
kartáčovaný titan  
kartáčovaný titán  
csiszolt titán  
titan periat



4  
starožitná mosaz  
starožitná mosadz  
antik bronz  
alama antică



30  
šedá  
sivá  
szürke  
gri



12  
černý chrom  
čierny chróm  
fekete króm  
crom negru



9  
starožitná kartáčovaná mosaz  
starožitná kartáčovaná mosadz  
antik szálcsiszolt sárgaréz  
alamă periată antică



pozinkovaný  
pozinkovaný  
galvanizált  
galvanizat



13  
titan  
titán  
titán  
titan



16  
zlatá mosaz  
zlatá mosadz  
aranyrész  
alamă aurie



22  
slonová kost  
slonová kost  
elefántcsont  
fildeş



52  
třešeň  
čerešňa  
cseresznye  
cireaşă



RZ  
růžová  
ružová  
rózsaszín  
roz



17  
hnědá  
hnedá  
barna  
maro



42  
hruška  
hruška  
körte  
pară



PM  
oranžová  
oranžová  
naranccsárga  
portocale



50  
béžová  
béžová  
bézs  
bej



30  
hnědá  
hnedá  
barna  
maro



15  
měď  
meď  
rész  
cupru



7, 31, 732  
tmavě hnědá  
tmavo hnedá  
sötétbarna  
maro inchis



44  
buk  
buk  
bükkfa  
fag



61  
tmavý mahagon  
tmavý mahagón  
sötét mahagóni  
mahon íntunecat



41  
olše  
jelša  
égerfa  
arin



20, 48, 731  
mahagon  
mahagón  
mahagóni  
mahon



43  
světle hnědá  
svetlo hnedá  
világos barna  
maro deschis



NB  
modrá  
modrá  
kék  
albastru



51  
calvados  
calvados  
calvados  
calvados



ZL  
zelená  
zelená  
zöld  
verde



**Stupeň krytí proti vniknutí prachu, pevných látek a vody**  
**Stupeň ochrany proti vniknutiu prachu, pevných látok a vody**  
**Por, szilárd anyagok és víz behatolása elleni védelem**  
**Grad de protecție împotriva prafului, solidelor și apei**

IP	Stupeň krytí I Trieda ochrany I Védelmi besorolás I Grad de protecție I
0	Žádný Žiadny Egyik sem Nici unul
1	Ochrana proti vniknutí předmětů > 50 mm. Ochrana proti vniknutiu predmetov > 50 mm. Védelem > 50 mm-es testek behatolása ellen. Protejat împotriva unui obiect solid de 50 mm sau mai mare
2	Ochrana proti vniknutí předmětů > 12 mm. Ochrana proti vniknutiu predmetov > 12 mm. Védelem 12 mm-nél nagyobb testek behatolása ellen. Protejat împotriva unui obiect solid de 12 mm sau mai mult
3	Ochrana proti vniknutí předmětů > 2,5 mm. Ochrana proti vniknutiu predmetov > 2,5 mm. Védelem 2,5 mm-nél nagyobb testek behatolása ellen. Protejat împotriva unui obiect solid de 2,5 mm sau mai mult
4	Ochrana proti vniknutí předmětů > 1 mm. Ochrana proti vniknutiu predmetov > 1 mm. Védelem > 1 mm-es testek behatolása ellen. Protejat împotriva unui obiect solid de 1 mm sau mai mult
5	Ochrana proti vniknutí prachu Ochrana proti vniknutiu prachu Védelem a por behatolása ellen Protecție împotriva pătrunderii prafului
6	Prachotěsný Prachotesný Pormentes Rezistent la praf

IP	Stupeň krytí II Trieda ochrany II Védelmi besorolás II Grad de protecție II
0	Žádný Žiadny Egyik sem Nici unul
1	Ochrana proti kapající vodě (vertikálně padající kapky). Ochrana proti kvapkajúcej vode (vertikálne padajúce kvapky). Víz elleni védelem (függőlegesen eső cseppenk). Protejat împotriva scurgerii pe verticală a apei
2	Ochrana proti kapající vodě při naklonění do 15°. Ochrana proti kvapkajúcej vode pri naklonení do 15°. 15 ° -ig döntött víz elleni védelem a csöpögő víz ellen. Protejat împotriva scurgerii pe verticală a apei, când este înclinat la 15 grade
3	Ochrana proti stříkající vodě. Ochrana proti striekajúcej vode. Vízpermet elleni védelem. Protejat împotriva pulverizării cu apă
4	Ochrana proti šplíhající vodě. Ochrana proti špliechajúcej vode. Vízcspepek elleni védelem. Protejat împotriva stropirii de apă
5	Ochrana proti postřiku vodou Ochrana proti postreku vodou Vízszugarak elleni védelem Protejat împotriva jeturilor de apă
6	Ochrana proti silnému postřiku vodou (vlny) Ochrana proti silnému postreku vodou (vlny) Védelem erős vízszugarak (hullámok) ellen Protecție împotriva jeturilor puternice de apă (valuri)
7	Ochrana proti ponoření Ochrana proti ponoreniu Védelem a merítés ellen Protejată împotriva imersării
8	Ochrana proti hlubokému ponoření Ochrana proti hlbokému ponoreniu Védelem a mély merülés ellen Protejată împotriva imersării la adancime mare



**Třída ochrany před úrazem elektrickým proudem**  
**Trieda ochrany pred úrazom elektrickým prúdom**  
**Érintésvédelmi osztály**  
**Clasa de protecție împotriva șocurilor electrice**

Bezpečnostní třída Bezpečnostná trieda Biztonsági osztály Clasa de siguranță	Symbol Symbol Szimbólum Simbol	Definice Definiția Meghatározás Definiție
<b>0</b>	žádné žiadne egyik sem niciunul	<p>Ochrana před úrazem elektrickým proudem závisí pouze na základní izolaci. V případě poruchy izolace musí být ochrana před úrazem elektrickým proudem zajištěna umístěním zařízení ve vhodném prostředí mimo možnosti přímého dotyku.</p> <p>Ochrana pred úrazom elektrickým prúdom závisí len od základnej izolácie. V prípade poruchy izolácie musí byť ochrana pred úrazom elektrickým prúdom zaistená umiestnením zariadenia vo vhodnom prostredí mimo možnosti priameho dotyku.</p> <p>Az áramütés elleni védelem csak az alapszigetelésen alapszik. Szigetelés meghibásodása esetén az áramütés elleni védelmet megfelelő kedvező környezeti feltételekkel és a berendezés közvetlen érintésetől elzárva történő elhelyezésével kell biztosítani.</p> <p>Protecția împotriva șocurilor electrice se bazează numai pe izolația de bază. În cazul unei defecțiuni a izolației, protecția împotriva șocurilor electrice trebuie să fie asigurată prin condiții de mediu adecvate și prin amplasarea echipamentului dincolo de atingerea contactului direct.</p>
<b>I</b>		<p>Zařízení třídy I poskytuje ochranu připojením všech vodivých částí pod napětím k ochrannému vodiči nebo přímo k uzemnění.</p> <p>Zariadenie triedy I poskytuje ochranu pripojením všetkých vodivých častí pod napätím k ochrannému vodiču alebo priamo k uzemneniu.</p> <p>Az I. osztályú berendezések védelmet nyújtanak azáltal, hogy az összes feszültség alatt álló vezetőrészt egy védővezetékhez vagy közvetlenül a földhöz köti.</p> <p>Echipamentele de clasa I oferă protecție prin conectarea tuturor părților conductoare sub tensiune la un fir de protecție sau direct la pământ.</p>
<b>II</b>		<p>Zařízení třídy II poskytuje ochranu pomocí dvojité nebo zesílené izolace, která je za daných podmínek prostředí při jmenovitém napětí považována za neproniknutelnou.</p> <p>Zariadenie triedy II poskytuje ochranu pomocou dvojitej alebo zosilnenej izolácie, ktorá je za daných podmienok prostredia pri nominálnom napätí považovaná za nepreniknuteľnú.</p> <p>A II. Osztályú berendezések kettős vagy megerősített szigeteléssel nyújtanak védelmet, amelyet a névleges feszültség mellett adott környezeti feltételek mellett töresbiztosnak kell tekinteni.</p> <p>Echipamentele de clasa II asigură protecție prin utilizarea izolației duble sau consolidate, care este considerată rezistentă la defecțiuni în condiții de mediu date la tensiunea nominală.</p>
<b>III</b>		<p>Ochrana zařízení třídy III před úrazem elektrickým proudem je zajištěna snížením napájecího napětí na hodnotu, která je za daných podmínek prostředí bezpečná.</p> <p>Ochrana zariadenia triedy III pred úrazom elektrickým prúdom je zaistená snížením napájacieho napätia na hodnotu, ktorá je za daných podmienok prostredia bezpečná.</p> <p>A III. Osztályú berendezések áramütés elleni védelmét az elektromos feszültség biztonságos környezeti határértékre történő csökkentése biztosítja, adott környezeti feltételek mellett.</p> <p>Protecția echipamentelor de clasa III împotriva șocurilor electrice este asigurată prin reducerea tensiunii de putere la o limită de siguranță în condiții de mediu date.</p>

# Indeks

## A

		AE-PB1SAVA-20	636	AE-WDBP1-20	608	A-HRS18-405-05	528
		AE-PB1SAVA-53	636	AE-WDBP2CCT-10	608	A-HRS18-405-90	528
A-B63-32	538	AE-PB1SAVAP-10	634	AE-WDBP2CCT-20	608	A-HRS18-600-05	528
A-B63-40	537	AE-PB1SAVAP-20	634	AE-WDSB-10DIM	613	A-HRS18-600-90	528
A-BUD-K-UB	544	AE-PB1SAVAP-53	634	AE-WDSC-10DIM	613	A-K18-300-05	525
A-BUDP-SET	544	AE-PB2FPRES-10	626	AE-WLB01-10	615	A-K18-300-10	525
A-BUD-UM	544	AE-PB2FPRES-20	626	AE-WLC01-20	615	A-K18-300-20M	525
A-BUD-UP	544	AE-PB2FPRES-53	626	AE-WLIP44-15	616	A-K18-300-90	525
A-BUD-UR	544	AE-PB2SPRES-10	626	AE-WLLAN1-10	617	A-KLP-4	536
A-C18-300-S-05	526, 541, 542	AE-PB2SPRES-20	626	AE-WLLAN1-20	617	A-KLP-4-20	536
A-C18-300-S-10	526	AE-PB2SPRES-53	626	AE-WLLAN1-90	617	A-KR-4	535
A-C18-300-S-20M	526	AE-PB03GS-10	643	AE-WLPR-60	615	A-KR-4-20	535
A-C18-300-S-90	526	AE-PB03GS-20	643	AE-WLPR-60P2	615	A-LD4MOV-300-05	524
A-DPG-16	531	AE-PB03GS-53	643	AE-WLSZNI-10	617	A-LD10-170-05	523
AE-BPW1FACP-10	628	AE-PB03GU-53	643	AE-WPDRW-00	614	A-LD10-235-05	523
AE-BPW1FACP-20	628	AE-PBC3GS2U-53BKS	646	AE-ZLADLUX-40	624	A-LD10-235-90	523
AE-BPW1S1UCH-51	639	AE-PBC3GS-51BK	646	AE-ZLADPOD-20	624	A-LD10-300-05	523
AE-BPW1S1UCH-53	638	AE-PBC3GS-53BKS	646	AE-ZUSB-20	623	A-LD10-300-10	523
AE-BPW1S2UCH-80	638	AE-PBC3GU-10	643	A-H16-300-05	526	A-LD10-300-20M	523
AE-BPW1SACP-10	628	AE-PBC3GU-20	643	A-H16-300-90	526	A-LD10-300-90	523
AE-BPW1SACP-20	628	AE-PBC3GU-51BK	646	A-H18-300-05	527	A-LD10-405-05	523
AE-BPW1U1UCH-51	639	AE-PBC3GU-53	643	A-H18-300-10	527	A-LD10-405-90	523
AE-BPW1U1UCH-53	638	AE-PBK3S2U-80	647	A-H18-300-20M	527	A-LD10-600-05	523
AE-BPW1U2UCH-80	638	AE-PBK3U2U-80	647	A-H18-300-90	527	A-LD10-600-90	523
AE-BPW2FCAM-10	632	AE-PBK74S-80	647	A-HR10-235-05	529	A-LD10FL-300-05	525
AE-BPW2FCAM-20	632	AE-PBK74U-80	647	A-HR10-235-90	529	A-LD10FL-300-10	525
AE-BPW2SCAM-10	632	AE-PBSC3GS-10	644	A-HR10-300-05	529	A-LD10FL-300-20M	525
AE-BPW2SCAM-20	632	AE-PBSC3GS-20N	644	A-HR10-300-10	529	A-LD10FL-300-90	525
AE-BPW3GS-20	640	AE-PBSC3GS-53	644	A-HR10-300-90	529	A-LD18-170-05	521
AE-BPW3GS-80	640	AE-PBSC3GU-10	644	A-HR10-405-05	529	A-LD18-170-90	521
AE-BPW3GU-20	640	AE-PBSC3GU-20N	644	A-HR10-405-90	529	A-LD18-235-05	521
AE-BPW3GU-80	640	AE-PBSC3GU-53	644	A-HR10-600-05	529	A-LD18-235-90	521
AE-BPW3S60-20	642	AE-PBSUC2GS-10	644	A-HR10-600-90	529	A-LD18-300-05	521
AE-BPW3S60-80	642	AE-PBSUC2GS-20N	644	AE-HR10FL-300-05	529	A-LD18-300-10	521
AE-BPW3S60U-20	642	AE-PBSUC2GS-53	644	A-HR10FL-300-10	529	A-LD18-300-20M	521
AE-BPW3S60U-80	642	AE-PBSUC2GU-10	644	A-HR10FL-300-20M	529	A-LD18-300-90	521
AE-BPW3S100U-53	639	AE-PBSUC2GU-20N	644	A-HR10FL-300-90	529	A-LD18-405-05	521
AE-BPW3U60-20	642	AE-PBSUC2GU-53	644	A-HR18-300-05	528	A-LD18-405-10	521
AE-BPW3U60-80	642	AE-PBU02GS-10	643	A-HR18-300-05RA	527	A-LD18-405-90	521
AE-BPW3U60U-20	642	AE-PBU02GS-20	643	A-HR18-300-10	528	A-LD18-600-05	521
AE-BPW3U60U-80	642	AE-PBU2GU-10	643	A-HR18-300-20M	528	A-LD18-600-90	521
AE-BPW3U100U-53	639	AE-PBU2GU-20	643	A-HR18-300-90	528	A-LD19-300-05	522
AE-BPW4F120P-10	630	AE-PBU2GU-53	643	A-HR18-300-90RA	527	A-LG4MOV-300-05	523
AE-BPW4F120P-20	630	AE-WBBUNI-10DIM	612	A-HR19-300-05	528	A-LG10-170-05	522
AE-BPW4S100-53	639	AE-WBCUNI-10DIM	612	A-HRS10-170-05	529	A-LG10-235-05	522
AE-BPW4S120P-10	630	AE-WBE1-10	612	A-HRS10-300-05	529	A-LG10-235-90	522
AE-BPW4S120P-20	630	AE-WBE1-20	612	A-HRS10-300-90	529	A-LG10-300-05	522
AE-BPW4U100-53	639	AE-WBE2-10	613	A-HRS10-405-05	529	A-LG10-300-10	522
AE-PB1FAVA-10	636	AE-WBE2-20	613	A-HRS10-600-05	529	A-LG10-300-20M	522
AE-PB1FAVA-20	636	AE-WBEZDB-10S	610	A-HRS18-170-05	528	A-LG10-300-90	522
AE-PB1FAVA-53	636	AE-WBEZDC-10S	610	A-HRS18-170-90	528	A-LG10-405-05	522
AE-PB1FAVAP-10	634	AE-WBEZDK15-10	610	A-HRS18-235-05	528	A-LG10-405-90	522
AE-PB1FAVAP-20	634	AE-WBEZDPIR2-20	611	A-HRS18-235-90	528	A-LG10-600-05	522
AE-PB1FAVAP-53	634	AE-WBEZDPIR-10	611	A-HRS18-300-05	528	A-LG10-600-90	522
AE-PB1SAVA-10	636	AE-WDBP1-10	608	A-HRS18-300-90	528	A-LG10FL-300-05	524

A-LG10FL-300-10	524	AM-OWM-DL-MG-10	110, 111	A-R10TORO-270-90	516	A-SO-R-145X4-20	534
A-LG10FL-300-20M	524	AM-OWM-DL-MG-30	110	A-R10TRAFO-270-05	515	A-SP-R-7X12	535
A-LG10FL-300-90	524	AM-OWM-DL-MG-60	110	A-R10TRAFO-270-90	515	A-SP-R-48X7	534
A-LG18-170-05	520	AM-OWM-KR-GM-10	110	A-R16ERG-220-05	510	A-SP-R-48X12	535
A-LG18-170-90	520	AM-OWM-KR-GM-30	110	A-R16ERG-230-50	510	A-T18-300-05	526
A-LG18-235-05	520	AM-OWM-KR-GM-60	110	A-R16ERG-270-50	510	A-T18-300-10	526
A-LG18-235-90	520	AM-OWM-KR-MG-10	110	A-R16ERG-270-90	510	A-T18-300-20M	526
A-LG18-300-05	520	AM-OWM-KR-MG-30	110	A-R18CARO-270-05	512	A-T18-300-90	526
A-LG18-300-10	520	AM-OWM-KR-MG-60	110	A-R18CARO-270-90	512	A-TDEVO2-170-05	519
A-LG18-300-20M	520	AM-PLA-DLU-0	111	A-R18COTE-270-05	513	A-TDEVO2-170-90	519
A-LG18-300-90	520	AM-PL-DL-MAG	111	A-R18COTE-270-90	513	A-TDEVO2-235-05	519
A-LG18-405-05	520	A-MPRO-170-05	520	A-R18ERG-270-05	510	A-TDEVO2-235-90	519
A-LG18-405-10	520	A-MPRO-170-10	520	A-R18ERG-270-20M	510	A-TDEVO2-300-05	519
A-LG18-405-90	520	A-MPRO-170-20M	520	A-R18ERG-270-90	510	A-TDEVO2-300-90	519
A-LG18-600-05	520	A-MPRO-170-90	520	A-R18GE02-270-05	510	A-TDEVO2-405-05	519
A-LG18-600-90	520	A-MPRO-235-05	520	A-R18LOCA-305-05	514	A-TDEVO2-405-90	519
A-LG19-300-05	521	A-MPRO-235-10	520	A-R18LOCA-305-90	514	A-TDEVO2-600-05	519
AM-ADAP0A-10	109	A-MPRO-235-20M	520	A-R18NERO-270-05	513	A-TDEVO2-600-90	519
AM-ADAP0A-60	109	A-MPRO-235-90	520	A-R18NERO-270-10	513	A-TDEVO-170-05	518
AM-ADAP0B-10	109	A-MPRO-300-05	520	A-R18NERO-270-20M	513	A-TDEVO-170-10	518
AM-ADAP0B-60	109	A-MPRO-300-10	520	A-R18NERO-270-90	513	A-TDEVO-170-20M	518
A-MEVO-170-05	518	A-MPRO-300-20M	520	A-R18NOVS-270-05	511	A-TDEVO-170-90	518
A-MEVO-170-10A	518	A-MPRO-300-90	520	A-R18NOVS-270-10	511	A-TDEVO-235-05	518
A-MEVO-170-20M	518	A-MPRO-405-05	520	A-R18NOVS-270-20M	511	A-TDEVO-235-10	518
A-MEVO-170-90	518	A-MPRO-405-10	520	A-R18NOVS-270-90	511	A-TDEVO-235-20M	518
A-MEVO-235-05	518	A-MPRO-405-20M	520	A-R18VIS-270-05	512	A-TDEVO-235-90	518
A-MEVO-235-10A	518	A-MPRO-405-90	520	A-R18VIS-270-20M	512	A-TDEVO-300-05	518
A-MEVO-235-20M	518	AMR-BP-0715	113	A-R18VIS-270-90	512	A-TDEVO-300-10	518
A-MEVO-235-90	518	AMR-BP-1003	113	A-R19NERO-300-05	513	A-TDEVO-300-20M	518
A-MEVO-300-05	518	A-MSOFT-ADAPT	539	A-R19NOVS-300-05	512	A-TDEVO-300-90	518
A-MEVO-300-10A	518	A-MSOFT-RAMA	538	A-RD-MITO	540	A-TDEVO-405-05	518
A-MEVO-300-20M	518	AM-ZAT-A1-10	113	A-RNOV2-270-05	511	A-TDEVO-405-10	518
A-MEVO-300-90	518	A-PG-18	530	A-RNOV2-270-10	511	A-TDEVO-405-20M	518
A-MEVO-405-05	518	A-PGR-10	530	A-RNOV2-270-20M	511	A-TDEVO-405-90	518
A-MEVO-405-10	518	A-PGR-10S	531	A-RNOV2-270-90	511	A-TDEVO-600-05	518
A-MEVO-405-20M	518	A-PGR-18	530	A-SG-MITO	540	A-TDEVO-600-10	518
A-MEVO-405-90	518	A-POZ-MITO	540	A-SN-ADSET	541, 542	A-TDEVO-600-20M	518
A-MITO-PLUS	540	A-PTD	533	A-SN-FSET	541	A-TDEVO-600-90	518
AM-KRZYZ-KPL	108	A-PTG	533	A-SN-HSET1	542	A-TDPRO-170-05	519
AM-MBSOFT-P2	165	A-PW-RC-DOC	539	A-SN-K19-270-05	541, 542	A-TDPRO-170-10	519
AM-OAM-DL-GM-10	112	A-R4MOV-270-05	514	A-SN-LOFT-200-20MN	545	A-TDPRO-170-20M	519
AM-OAM-DL-GM-30	112	A-R10ARCO-270-05	516	A-SN-POZ	542	A-TDPRO-170-90	519
AM-OAM-DL-GM-60	112	A-R10ARCO-270-90	516	A-SN-R19RIV-270-05	541, 542	A-TDPRO-235-05	519
AM-OAM-DL-MG-10	112	A-R10FALDA-270-05	516	A-SN-SDP-TU	543	A-TDPRO-235-10	519
AM-OAM-DL-MG-30	112	A-R10FALDA-270-20M	516	A-SN-SOFT-25Z	541, 542	A-TDPRO-235-20M	519
AM-OAM-DL-MG-60	112	A-R10FALDA-270-90	516	A-SN-SOFT-40Z	541, 542	A-TDPRO-235-90	519
AM-OAM-KR-GM-10	112	A-R10FL-270-05	514	A-SN-TDS-405-00	541	A-TDPRO-300-05	519
AM-OAM-KR-GM-30	112	A-R10FL-270-10	514	A-SN-TDT-405-00	542	A-TDPRO-300-10	519
AM-OAM-KR-GM-60	112	A-R10FL-270-20M	514	A-SN-TG-405-00	541, 542	A-TDPRO-300-20M	519
AM-OAM-KR-MG-10	112	A-R10FL-270-90	514	A-SOFT-30	538	A-TDPRO-300-90	519
AM-OAM-KR-MG-30	112	A-R10FORM-270-05	515	A-SOFT-30Z	538	A-TDPRO-405-05	519
AM-OAM-KR-MG-60	112	A-R10FORM-270-90	515	A-SOFT-50	538	A-TDPRO-405-10	519
AM-ODB000-10	108	A-R10NOV-270-05	515	A-SOFT-50Z	538	A-TDPRO-405-20M	519
AM-ODB000-60	108	A-R10NOV-270-10	515	A-SO-R-48X4	534	A-TDPRO-405-90	519
AM-OWM-DL-GM-10	110	A-R10NOV-270-20M	515	A-SO-R-48X4-20	534	A-TDPRO-600-05	519
AM-OWM-DL-GM-30	110	A-R10NOV-270-90	515	A-SO-R-145X4	534	A-TDPRO-600-10	519
AM-OWM-DL-GM-60	110	A-R10TORO-270-05	516	A-SO-R-145X4-10	534	A-TDPRO-600-20M	519

A-TDPRO-600-90	519	GP-0728-J4-C-04	416	GZ-TERNI-1-01	348, 378	KK-W60800-24	335
A-TG-170-05	517	GP-0728-J4-R	416	GZ-TERNI-1-02	378	KK-W60800-M0	335
A-TG-170-10	517	GS-BERGA-1-01	377	GZ-TERNI-1-05	378	KK-W60800-M1	335
A-TG-170-20M	517	GS-BERGA-1-02	377	GZ-TERNI-1-06	378	KK-W60800-M2	335
A-TG-170-90	517	GS-BERGA-1-05	377	GZ-TERNI-1-09	378	KK-W80480-05	336
A-TG-235-05	517	GS-BERGA-1-06	377	GZ-TERNI-1-10	378	KK-W80480-06	336
A-TG-235-10	517	GS-BERGA-1-10	377	GZ-TERNI-1-12	378	KK-W80480-10	336
A-TG-235-20M	517	GS-BERGA-1-12	377	GZ-TERNI-1-15	378	KK-W80480-20M	336
A-TG-235-90	517	GS-BERGA-1-20M	377	GZ-TERNI-1-16	378	KK-W80480-21	336
A-TG-300-05	517	GS-BERGA-1-90	377	GZ-TERNI-1-20M	378	KK-W80480-24	336
A-TG-300-10	517	GZ-ARDEA-1-09	425	GZ-UDINE-1-01	378	KK-W80800-06	335
A-TG-300-20M	517	GZ-CENTO-1-04	421	GZ-UDINE-1-02	378	KK-W80800-21	335
A-TG-300-90	517	GZ-CENTO-1-07	421	GZ-UDINE-1-05	378	KK-W80800-24	335
A-TG-405-05	517	GZ-CENTO-1-14	421	GZ-UDINE-1-06	378	KK-W80800-D0	335
A-TG-405-10	517	GZ-CENTO-1-20M	421	GZ-UDINE-1-10M	378	KK-W80800-D1	335
A-TG-405-20M	517	GZ-CRPA20-01	433	GZ-UDINE-1-12N	378	KK-W80800-D2	335
A-TG-405-90	517	GZ-CRPA25-01	433	GZ-UDINE-1-20M	378	KM-00-40-D20	500
A-TG-600-05	517	GZ-CRPA30-01	433	GZ-VENICE-1-20M	366	KM-00-50-D20	500
A-TG-600-10	517	GZ-CRPA30-03	433	GZ-VENICE-1-90	366	KM-0H-40-D20	500
A-TG-600-20M	517	GZ-CRPA30-A1	433	GZ-WP1136-04	430	KM-0H-50-D20	500
A-TG-600-90	517	GZ-CRPA40-01	433	GZ-WP1148-04	431	KM-015030-10	500
A-TG-BUD-200-00	544	GZ-CRPB20-01	433	GZ-WP1152-04	431	KM-015030-20	500
A-TG-BUD-300-00	544	GZ-CRPB25-01	433	GZ-WP1155-01	388	KM-015038-10	500
A-TMITO-200-00	540	GZ-CRPB25-A1	433	GZ-ZH-011-05A	388	KM-015038-GM	501
A-TMITO-200-05	540	GZ-CRPB30-01	433			KM-A035MM-00	501
A-TMITO-250-00	540	GZ-CRPB30-03	433	<b>H</b>		KM-A035MM-30	501
A-TMITO-250-05	540	GZ-CRPB30-A1	433	HB-USB-4X-60	321	KM-A050MM-00	502
A-TMITO-300-00	540	GZ-CRPB40-01	433			KM-A050MM-30	502
A-TMITO-300-05	540	GZ-CRPB40-A1	433	<b>I</b>		KM-AH35MM-00	501
A-USZCZ-CHM4	537	GZ-CRPC30-01	434	ID-GZ-CRPJ30-01	434	KM-AH35MM-30	501
A-USZCZ-CHM4-20	537	GZ-LORENA-1-03	373	ID-GZ-CRPJ40-01	434	KM-AH50MM-00	502
A-USZCZ-TDEVO2	537	GZ-LORENA-1-18	373	ID-RS-E-15696-20M	390	KM-AH50MM-30	502
A-USZCZ-U4	536	GZ-LORENA-1-20M	373	ID-RS-E-188128-20M	390	KM-B050MM-00	502
A-WD-EVO2	531	GZ-LORENA-1-21	373	ID-RS-E-220160-06	390	KM-B050MM-30	502
A-WD-PRO	532	GZ-MILAN-32-20M	354	ID-RS-E-220160-20M	390	KM-B075MM-00	503
A-WDR-EVO	532	GZ-NORD-1-03	364	ID-RS-E-272192-06	390	KM-B075MM-30	503
A-WDR-PRO	533	GZ-NORD-1-18	364	ID-RS-E-272192-20M	390	KM-BH50MM-00	502
A-ZAC-WDEVO2	532	GZ-NORD-1-20M	364	ID-RS-E-304224-06	390	KM-BH50MM-30	502
A-ZAT-TDEVO2	536	GZ-OLBIA-1-04	424	ID-RS-E-304224-20M	390	KM-BH75MM-00	503
		GZ-PALER-1-07	424	ID-RS-E-336256-06	390	KM-BH75MM-30	503
		GZ-PIAZZA-1-03	349	ID-RS-E-336256-20M	390	KM-GREYROLL-50mm-BH	505
<b>B</b>		GZ-PIAZZA-1-06	349	ID-RS-E-368288-06	390	KM-GREYROLL-50mm-ZH	505
BP-SLZIGW-10	477	GZ-PIAZZA-1-18	349	ID-RS-E-368288-20M	390	KM-GREYROLL-75mm-BH	505
BP-SLZIGW-21	477	GZ-PIAZZA-1-20M	349	ID-RS-E-400320-06	390	KM-GREYROLL-75mm-ZH	505
		GZ-POINT-1-06	372	ID-RS-E-400320-20M	390	KM-RD-35-CF	503
<b>E</b>		GZ-POINT-1-18	372			KM-RD-35-CF-20	503
EM-SBL065-01-A	246	GZ-RING-1-18	368	<b>K</b>		KM-RD-35-SF	503
EM-SBL100-01-A	246	GZ-RING-1-20M	368	KK-D50-80-06	334	KM-RD-35-SF-20	503
EM-SBL150-01-A	246	GZ-ROYAL3-1-10-03	429	KK-D50100-06	334	KM-RD-50-CF	504
		GZ-SONET-1-07	423	KK-W60245-21	333	KM-RD-50-CF-20	504
<b>G</b>		GZ-SONET-1-18	423	KK-W60245-24	333	KM-RD-50-SF	504
GA-IMPER-1-02B	422	GZ-SONET-1-20M	423	KK-W60245-M0	333	KM-RD-50-SF-20	504
GA-IMPER-1-11	422	GZ-SPOT-1-03	345	KK-W60245-M1	333	KM-RD-75-CF	504
GA-IMPER-1-20M	422	GZ-SPOT-1-06	345	KK-W60245-M2	333	KM-RD-75-CF-20	504
GA-STRUCTURE-1-20M	379	GZ-SPOT-1-10	345	KK-W60245-M6	333	KM-RD-75-SF	504
GP-0728-J4-A-04	416	GZ-SPOT-1-18	345	KK-W60800-06	335	KM-RD-75-SF-20	504
GP-0728-J4-A-07	416	GZ-SPOT-1-20M	345	KK-W60800-21	335	KM-SPAIN-40MM-18	505
GP-0728-J4-B	416						

KM-SPAIN-50MM-18	505	LB-80X160-20	323	LD-3528-600-20-ZB-50	552	LD-PIRUSB-53	594
KO-150BO-01	308	LB-80X280-05	323	LD-3528-600-65-CB	550	LD-RA60CB-40N	593
KO-150BO-01B	308	LB-80X280-20	323	LD-3528-600-65-NE4	550	LD-RA60ZB-40N	593
KO-150BO-60	308	LB-80X500-05	324	LD-3528-600-65-ZB	550	LD-RGB-150-20	551
KO-150BO-E-01	311	LB-80X500-20	324	LD-5050-300-20-CB	551	LD-RGB-150-65	551
KO-200BO-01	308	LB-K80X80-05	322	LD-5050-300-20-NE4	551	LD-RGBW-300-20	551
KO-200BO-01B	308	LB-K80X80-20	322	LD-5050-300-20-NE4-50	552	LD-TR24CB-53	591
KO-200BO-60	308	LD-35KL-ZBN	595	LD-5050-300-20-ZB	551	LD-TR24NE-53	591
KO-200BO-E-01	311	LD-2835-24V-300-20-CB	552	LD-5050-300-65-CB	551	LD-TR24ZB-53	591
KO-300BO-01	310	LD-2835-24V-300-20-NE4	552	LD-5050-300-65-NE4	551	LD-UNF-12V6X12-6X	555
KO-300BO-01B	310	LD-2835-24V-300-20-ZB	552	LD-5050-300-65-ZB	551	LD-VA24CB-53	588
KO-300BO-60	310	LD-2835-24V-600-20-CB	552	LD-5630-300-20-CB	551	LD-VA24NE-53	588
KO-400BO-01	310	LD-2835-24V-600-20-NE4	552	LD-5630-300-20-NE4	551	LD-VE15CB-53N	590
KO-400BO-01B	310	LD-2835-24V-600-20-ZB	552	LD-5630-300-20-NE4-50	552	LD-VE15CBZB-53N	591
KO-400BO-60	310	LD-2835-60-60-20-CCT	551	LD-5630-300-20-ZB	551	LD-VE15NE-53N	590
KO-500BO-01	310	LD-2835-300-20-CB	550	LD-5630-300-65-CB	551	LD-VE15ZB-53N	590
KO-500BO-01B	310	LD-2835-300-20-CB-50	552	LD-5630-300-65-NE4	551	LD-WZA20W-NW	599
KO-500BO-60	310	LD-2835-300-20-CBN	550	LD-5630-300-65-ZB	551	LD-WZA36W-NW	599
KO-SR100-30-10	287	LD-2835-300-20-NE4N	550	LD-AL24CB-53	590	LD-WZA60W-NW	599
KO-SR100-40-10	287	LD-2835-300-20-NE4P	550	LD-AL24NE-53	590	LD-WZA80W-NW	599
KO-SR100-50-10t	287	LD-2835-300-20-NE4P-50	552	LD-AL24ZB-53	590	LD-WZA150W-NW	599
KO-SR100-60-10	287	LD-2835-300-20-ZB	550	LD-BOS1CBWG-53	594	LD-ZAC6WDE-RGB	601
KO-SR150-30-10	287	LD-2835-300-20-ZB-50	552	LD-COB12V-20-CBN	554	LD-ZAS09WEC-30	595
KO-SR150-40-10	287	LD-2835-300-20-ZBN	550	LD-COB12V-20-CBPQ	554	LD-ZAS15WEC-30	595
KO-SR150-50-10	287	LD-2835-300-65-CB	550	LD-COB12V-20-NEN	554	LD-ZAS20WEC-30	595
KO-SR150-60-10	287	LD-2835-300-65-CBN	550	LD-COB12V-20-NEPQ	554	LD-ZAS24PRO16W-30	596
KO-SR200-30-10	287	LD-2835-300-65-NE4	550	LD-COB12V-20-ZBN	554	LD-ZAS24PRO33W-30	596
KO-SR200-40-10	287	LD-2835-300-65-NE4N	550	LD-COB12V-20-ZBPQ	554	LD-ZAS24PRO54W-30	596
KO-SR200-50-10	287	LD-2835-300-65-ZB	550	LD-COB24V-20-CBN	554	LD-ZAS24PRO80W-30	596
KO-SR200-60-10	287	LD-2835-300-65-ZBN	550	LD-COB24V-20-NEN	554	LD-ZAS30WEC-30	595
KO-UMC450-01	307	LD-2835-600-5MM-20-CB	551	LD-COB24V-20-ZBN	554	LD-ZAS60WEC-30	595
KO-UMC450-01B	307	LD-2835-600-5MM-20-NE4	551	LD-CS36CB-53	589	LD-ZAS75W-30	596
KO-UMC450-60	307	LD-2835-600-5MM-20-ZB	551	LD-CS36NE-53	589	LD-ZAS150-NW	598
KO-WMC450-01	306	LD-2835-600-20-CB	550	LD-CS36ZB-53	589	LD-ZAS350-NW	599
KO-WMC450-01B	306	LD-2835-600-20-NE4	550	LD-DIMLED-10	616	LD-ZASNF-12V6X12-65	555
KO-WMC450-60	306	LD-2835-600-20-ZB	550	LD-IRUSB-53	594	LD-ZASPRO07W-30	598
KO-WMC500-01	306	LD-2835-600-65-CB	550	LD-KABE2M-00	618	LD-ZASPRO12W-30	598
KO-WMC500-01B	306	LD-2835-600-65-NE4	550	LD-KLPCB-00N	595	LD-ZASPRO16W-30	598
KO-WMC500-60	306	LD-2835-600-65-ZB	550	LD-KLPNB-00N	595	LD-ZASPRO24W-30	598
KT-WP1147-04	432	LD-3014-1200-20-CB	551	LD-KLPZB-00N	595	LD-ZASPRO33W-30	598
KW-FS0125-01	238	LD-3014-1200-20-NE4	551	LD-KONMINI-RGB	602	LD-ZASPRO54W-30	598
KW-FS0140-01	238	LD-3014-1200-20-ZB	551	LD-KONML-MONO	603	LD-ZASPRO65W-30	598
KW-FS0335-01	239	LD-3528-300-20-CB	550	LD-KONML-MONO-PAN	604	LD-ZASPRO80W-30	598
KW-FS0350-01	239	LD-3528-300-20-CB-50	552	LD-KONML-MONO-PIL	603	LD-ZASPU15W-30N	600
KW-FS0375-01	239	LD-3528-300-20-NE4P	550	LD-KONML-RGBW	604	LD-ZL5RGB150-00	553
KW-FS0425-03	239	LD-3528-300-20-NE4P-50	552	LD-KONML-RGBW-PIL	605	LD-ZSKL15-00N	600
KW-FS0450-03	239	LD-3528-300-20-NI	550	LD-KONML-WIFI	606	LD-ZTK8-COB	620
KW-FS0650-01	240	LD-3528-300-20-ZB	550	LD-KONML-WIRGB-PAN	605	LD-ZTK8MM-02N600	622
		LD-3528-300-20-ZB-50	552	LD-KWP27CB-53	593	LD-ZTK10MM-02N	622
		LD-3528-300-65-CB	550	LD-LU16CB-53	588	LD-ZTKS8MM-02N	622
LB-51X180-05	324	LD-3528-300-65-NE4	550	LD-LU16NE-53	588	LD-ZTK8MM-02N600	621
LB-51x180-20	324	LD-3528-300-65-ZB	550	LD-LU16ZB-53	588	LD-ZTKT10MM-02N	621
LB-51X450-05	324	LD-3528-600-20-CB	550	LD-NF12V6x12-65-CB	555	LD-ZTKTRGB-04N	621
LB-51x450-20	324	LD-3528-600-20-CB-50	552	LD-NF12V6x12-65-NE	555	LD-ZTL8-COB	620
LB-80X100-05	322	LD-3528-600-20-NE4	550	LD-NF12V6x12-65-ZB	555	LD-ZTL8MM-02N600	621
LB-80X100-20	322	LD-3528-600-20-NE4-50	552	LD-OBP27CB-53	592	LD-ZTL10MM-02N	621
LB-80X160-05	323	LD-3528-600-20-ZB	550	LD-OBP27ZB-53	592	LD-ZTL82MAMP-COB	620

LD-ZTL82M-COB	620	MM-FI20X6X7-PL80-A-1T	246	MR-WP2806-01	267	NM-A80870-10	486
LD-ZTLR6B-04N	621	MM-FI20X6X7-ZN-A-1T	246	MR-WP2807-20	268	NM-A80870-20	486
LD-ZTL85MM-02N	622	MP-054350-10	163	MR-WP2815-01	266	NM-A80870-80	486
LD-ZTL85MMAMP-02N	622	MP-054400-10	163	MR-WPS01-001	269	NM-ARTO-10-2R304-20M	493
LD-ZTL852M-2N	622	MP-054450-10	163	MR-WPS03-001	269	NM-ARTO-10-2R406-20M	493
LD-ZWND6W-10	601	MP-054450-80	163	MR-WP2002-01	257	NM-ARTO-10-2R711-20M	493
LD-ZWND12-10	601	MP-054500-10	163	MR-WP2003-01	257	NM-ARTO-10-3R304-20M	492
LD-ZZAS12PROKD6	597	MP-054500-80	163	MR-WP2023-01	268	NM-ARTO-10-3R406-20M	492
LD-ZZAS16PROKD6	597	MP-086270-10	163	MR-ZSL011-01	233	NM-ARTO-10-3R711-20M	492
LD-ZZAS24PROKD6	597	MP-086300-10	163			NM-ARTO-12-2R304-20M	493
LD-ZZAS33PROKD6	597	MP-086350-10	163			NM-ARTO-12-2R406-20M	493
LD-ZZASG18KWD6	600	MP-086350-80	163	<b>N</b>		NM-ARTO-12-2R711-20M	493
LMB-BOCZ38L-05	251	MP-086400-10	163	NM-46R710-05	498	NM-ARTO-12-3R304-20M	492
LMB-BOCZ38L-20M	251	MP-086400-80	163	NM-46R820-05	498	NM-ARTO-12-3R406-20M	492
LMB-BOCZ38P-05	251	MP-086450-10	163	NM-60R710-05	498	NM-ARTO-12-3R711-20M	492
LMB-BOCZ38P-20M	251	MP-086450-80	163	NM-60R710-06	498	NM-ARTO-12-3R711-20M	492
LMB-KAT38-05	252	MP-086500-10	163	NM-60R710-20	498	NM-BAHIA40-150-01	468
LMB-KAT38-20M	252	MP-086500-80	163	NM-60R820-05	498	NM-BD-001-M1B	472
LMB-SZCZ38-05	253	MP-086550-10	163	NM-A60710-01	485	NM-BD-003-01	464
LMB-SZCZ38-20M	253	MP-118350-10	163	NM-A60710-02	485	NM-BD-003-02	464
LO-00-00-001	251	MP-118400-10	163	NM-A60710-05	485	NM-BD-100-01	465
LO-00-00-003	251	MP-118450-10	163	NM-A60710-06	485	NM-BD-100-02	465
LO-M2M-00-125-A	245	MP-118500-10	163	NM-A60710-10N	485	NM-BD-100-05	465
LZ-AKZ312-10N	619	MP-150270-10	163	NM-A60710-20	485	NM-BD-100-06	465
LZ-AKZ612-10N	620	MP-150300-10	163	NM-A60710-80N	485	NM-BD-150-01	464
LZ-KA2MM-10	618	MP-150350-10	163	NM-A60820-01	485	NM-BD-150-02	464
LZ-KAPR2M-10	619	MP-150400-10	163	NM-A60820-02	485	NM-BD-712-M1	472
		MP-150450-10	163	NM-A60820-05	485	NM-BD727-100	470
		MP-150500-10	163	NM-A60820-06	485	NM-BD-739-05	470
		MP-150550-10	163	NM-A60820-10N*	485	NM-BD-762-01	466
<b>M</b>				NM-A60820-20	485	NM-BD-762-05	466
MA-MATA-1-10	220	MR-R0050-001	256	NM-A60820-80N	485	NM-BD-780-M1	465
MA-MATA-1-20	220	MR-RDR0-0000	254	NM-A60870-01*	485	NM-BD-780-M2	465
MA-MATA-1-60	220	MR-RS025-001	256	NM-A60870-02*	485	NM-BD-780-M5	465
MC-J01A-12-01	230	MR-SPG-UNI-GAL	127	NM-A60870-05*	485	NM-BD867-100	466
MC-J01A-12-06	230	MR-SPG-UNI-OC	127	NM-A60870-06*	485	NM-BD868-100	467
MC-J01A-16-01	230	MR-TDL011-01	233	NM-A60870-10N*	485	NM-BD868-150	467
MC-J01A-16-06	230	MR-TH002-L01	263	NM-A60870-20*	485	NM-BD869-150	467
MC-J04A2-14-01	231	MR-TH002-P01	263	NM-A60870-80N*	485	NM-DAK27-060	471
MC-J04A2-14-05	231	MR-TH004-001	261	NM-A61100-01	485	NM-DAK27-080	471
MC-J04A2-18-01	231	MR-TH005-001	260	NM-A61100-02	485	NM-DAK27-100	471
MC-J04A2-22-01	231	MR-TH009-001	262	NM-A61100-05	485	NM-DAK27-120	471
MC-J60A27-01	231	MR-TH016-001	260	NM-A61100-06	485	NM-DAK27-150	471
MC-J62-01 232		MR-TH018-KPL	261	NM-A61100-10N*	485	NM-DAP77-60	468
MC-J63-05 228		MR-TH018-L01	264	NM-A61100-20	485	NM-DAP77-100	468
MC-J65-08-01	229	MR-TH018-P01	264	NM-A80710-01	486	NM-DAP77-150	468
MC-J65-08-05	229	MR-TH019-001	265	NM-A80710-02	486	NM-DPA20-100	480
MC-J65-10-01	229	MR-TH019-003	265	NM-A80710-03	486	NM-DPA20-100W	480
MC-J65-10-05	229	MR-TH035-KPL	262	NM-A80710-05	486	NM-DPA20-150	480
MC-J65-12-01	229	MR-THA12-001	259	NM-A80710-06	486	NM-DPA20-150W	480
MC-J65-12-05	229	MR-THB12-001	259	NM-A80710-10	486	NM-DPD20-100	479
MC-J123-01	229	MR-THQZ1-001	264	NM-A80710-20	486	NM-F50710-01	489
MC-J123-05	229	MR-WP-010-01	258	NM-A80710-80	486	NM-F50710-06	489
MC-K135-06-01	230	MR-WP-011-01	258	NM-A80870-01	486	NM-F50710-10	489
MG-MENSA-010	250	MR-WP-15-KPL	263	NM-A80870-02	486	NM-F50710-20	489
MG-MENSA-030	250	MR-WP-028-01	254	NM-A80870-03	486	NM-F50870-01	489
MM-FI20X6X7-PL10-A-1T	246	MR-WP2802-01	266	NM-A80870-05	486	NM-F50870-06	489
MM-FI20X6X7-PL20-A-1T	246	MR-WP2804-01	267	NM-A80870-06	486	NM-F50870-10	489

NM-F50870-20	489	NM-S60710-06A	488	OM-OBO400-05	336	PA-GLAXNBDW3M16-AL	583
NM-G60710-01N	487	NM-S60710-10A	488			PA-GLAXNBDW3M19-AL	583
NM-G60710-02N	487	NM-S60710-20A	488	<b>P</b>		PA-GLAXNBDW3M19-AL	583
NM-G60710-05N	487	NM-S60820-01A	488	PA-0242-35-50	404	PA-GLAXNBJ3M16-AL	580
NM-G60710-06N	487	NM-S60820-02A	488	PA-0242-35-50-06	404	PA-GLAXNBJ3M19-AL	580
NM-G60710-10N	487	NM-S60820-05A	488	PA-0242-35-50-20M	404	PA-GLAXNBJ3M-AL	580
NM-G60710-20N	487	NM-S60820-06A	488	PA-0243-35-50	405	PA-GLAXNBJW3M16-AL	581
NM-G60710-80N	487	NM-S60820-10A	488	PA-0243-35-50-06	405	PA-GLAXNBJW3M19-AL	581
NM-G60820-01N	487	NM-S60820-20A	488	PA-0243-35-50-20M	405	PA-GLAXNBJW3M-AL	581
NM-G60820-05N	487	NM-SQ40ADJ-060	469	PA-CPGLAXAH-00	556, 558,	PA-GLAXNK3M-AL	567
NM-G60820-06N	487	NM-SQ40ADJ-100	469		560, 562, 564	PA-GLAXNK-AL	567
NM-G60820-10N*	487	NM-SQA100-01	469	PA-CPGLAXAV-00	556, 558,	PA-GLAXNKKT3M-AL	575
NM-G60820-20N	487	NM-SQA150-01	469		560, 562, 564	PA-GLAXNKKT3M-AL-10	575
NM-G61100-01N	487	NM-STGY135-100-01	473	PA-CPGLAXL-00	556, 558,	PA-GLAXNKKT3M-AL-20M	575
NM-G61100-20N	487	NM-STGY135-130-01	473		560, 562, 564	PA-GLAXNKKT-AL	575
NM-INDUSTRIA-H20-710X-		NM-STGY135-150-01	473	PA-GLAX3M-AL	570	PA-GLAXNKKT-AL-10	575
820-20M	494	NM-STOMP-100-01	473	PA-GLAX3M-AL-10	570	PA-GLAXNKKT-AL-20M	575
NM-INDUSTRIA-H40-710X-		NM-STOMP-120-10	473	PA-GLAX3M-AL-20M	570	PA-GLAXNKKT-AL-90	575
820-20M	494	NM-STOMP-120-20	473	PA-GLAX-AL	570	PA-GLAXRAD-AL	573
NM-INDUSTRIA-P20-710X-		NM-STOMP-130-01	473	PA-GLAX-AL-10	570	PA-GLAXREG1-AL	579
820-20M	495	NM-STOMP-130-06	473	PA-GLAX-AL-20M	570	PA-GLAXREG2-AL	579
NM-INDUSTRIA-P40-710X-		NM-STOMP-130-20	473	PA-GLAX-AL-90	570	PA-GLAXWN3M-AL	574
820-20M	495	NM-STOMP-150-01	473	PA-GLAXDR-AL	572	PA-GLAXWN3M-AL-06	574
NM-INDUSTRIA-P80-710X-		NM-STOMP-160-01	473	PA-GLAXGKL3M-00C	556	PA-GLAXWN3M-AL-10	574
820-20M	495	NM-STOMP-160-06	473	PA-GLAXGK3M-00C	558	PA-GLAXWN3M-AL-20M	574
NM-INDUSTRIA-T20-710X-		NM-STOMP-160-20	473	PA-GLAXGKW3M-00C	560	PA-GLAXWN16-AL	574
820-20M	496	NM-STOPKA-M6	478	PA-GLAXGKWK3M-00C	562	PA-GLAXWN19-AL	574
NM-INDUSTRIA-T40-710X-		NM-STOPKSZESTK-M6	478	PA-GLAXGKZK3M-00C	564	PA-GLAXWN-AL	574
820-20M	496	NM-WPJ22-D20	476	PA-GLAXKT3M-AL	584	PA-GLAXWPKT-AL	585
NM-INDUSTRIA-X20-710X-		NM-X-LINE40710-01	490	PA-GLAXKT-AL	584	PA-LACZVELLO-CIN-05	414
820-20M	497	NM-X-LINE40710-10	490	PA-GLAXMIC3M-AL	569	PA-LACZVELLO-CIN-06	414
NM-INDUSTRIA-X40-710X-		NM-X-LINE40710-20	490	PA-GLAXMIC-AL	569	PA-LACZVELLO-CIN-10M	414
820-20M	497			PA-GLAXMICNK3M-AL	565	PA-LACZVELLO-CIN-20M	414
NM-INDUSTRIA-X80-710X-		<b>O</b>		PA-GLAXMICNK-AL	565	PA-LACZVELLO-CIN-21	414
820-20M	497	OC-2PV340-02-18	316	PA-GLAXMNBW3M19-AL	577	PA-LACZVELLO-COUT-05	414
NM-KL-DPA-20	481	OC-2PV345-02-18	316	PA-GLAXMNBW3M-AL	577	PA-LACZVELLO-COUT-06	414
NM-KL-DPL-20	480	OC-2PV350-02-18	316	PA-GLAXMNBW3M19-AL	576	PA-LACZVELLO-COUT-10M	414
NM-MDN926-01	475	OC-2PV360-02-18	316	PA-GLAXMNBW3M-AL	576	PA-LACZVELLO-COUT-20M	414
NM-MDN927-01	475	OC-2PV360-02-18A	316	PA-GLAXMNK3M-AL	566	PA-LACZVELLO-COUT-21	414
NM-MDN941-01	476	OC-2PV370-02-18	316	PA-GLAXMNK3M-AL-10	566	PA-LACZVELLO-LIN-05	415
NM-MDN-D4-01	474	OC-2PV380-02-18	316	PA-GLAXMNK3M-AL-20M	566	PA-LACZVELLO-LIN-06	415
NM-MLA-50-75	481	OC-2PV380-02-18A	316	PA-GLAXMNK-AL	566	PA-LACZVELLO-LIN-10M	415
NM-MLA-65-85	482	OC-2PV390-02-18	316	PA-GLAXMNK-AL-10	566	PA-LACZVELLO-LIN-20M	415
NM-MLA-85-125	482	OC-A0150-06	315	PA-GLAXMNK-AL-20M	566	PA-LACZVELLO-LIN-21	415
NM-MLA-95-145	483	OC-A0160-06	315	PA-GLAXMNK-AL-90	566	PA-LACZVELLO-LOUT-05	415
NM-MLA-125-195	483	OC-A0170-06	315	PA-GLAXMKNK-AL	568	PA-LACZVELLO-LOUT-06	415
NM-MLA-KL	484	OC-A0180-06	315	PA-GLAXMKNK-AL-10	568	PA-LACZVELLO-LOUT-10M	415
NM-MUFAWB-00	479	OC-A0190-06	315	PA-GLAXMKNK-AL-20M	568	PA-LACZVELLO-LOUT-20M	415
NM-MUFAWK-00	479	OC-A0350K-06	318	PA-GLAXMKNK-AL-90	568	PA-OSCLGLAX-00	570, 574, 575
NM-NACK27651-06	471	OC-A0450-06	318	PA-GLAXMPK-AL	578	PA-OSCLGLAX3M-00	570, 574, 575
NM-RONDA-150-18	474	OC-A0460D-06	319	PA-GLAXMW-AL	571		570, 574, 575
NM-RONDA-150-20M	474	OC-A0660-06	315	PA-GLAXMW-AL-10	571		570, 574, 575
NM-RONDA-180-18	474	OC-A0680-06	315	PA-GLAXMW-AL-20M	571		570, 574, 575
NM-RONDA-180-20M	474	OC-E0707D-CZ	319	PA-GLAXMW-AL-90	571	PA-OSCLGLAXM-00	566
NM-S60710-01A	488	OM-OBK150-20B	337	PA-GLAXNBD3M16-AL	582	PA-OSCLGLAXM3M-00	
NM-S60710-02A	488	OM-OBK175-20	337	PA-GLAXNBD3M19-AL	582		556, 558, 560,
NM-S60710-05A	488	OM-OB0300-05	336	PA-GLAXNBD3M-AL	582		562, 564, 566

PA-OSMLGLAX-00	567, 570,	PA-VELLO-L4M-10	406	PA-ZASVELLO-LNP-10	406	PB-3D0SHX18-450-H	129
	572, 573, 574, 575,	PA-VELLO-L4M-20	406	PA-ZASVELLO-LNP-20M	406	PB-3D0SHX18-450-PRO	128
	579, 584, 585	PA-VELLO-L4M-21	406	PA-ZASVELLO-LNP-21	406	PB-3D0SHX18-500-H	129
PA-OSMLGLAX3M-00	567, 570,	PA-VELLO-TD3M-05	412	PA-ZASVELLO-LPL-05	406	PB-3D0SHX18-500-PRO	128
	574, 575, 580, 581,	PA-VELLO-TD3M-06	412	PA-ZASVELLO-LPL-06	406	PB-3D0SHX18-550-H	129
	582, 583, 584	PA-VELLO-TD3M-10	412	PA-ZASVELLO-LPL-10	406	PB-3D0SHX18-550-PRO	128
PA-OSMLGLAXM-00		PA-VELLO-TD3M-20M	412	PA-ZASVELLO-LPL-20M	406	PB-3D0SHX18-600-H	129
	566, 568, 571, 578	PA-VELLO-TD3M-21	412	PA-ZASVELLO-LPL-21	406	PB-45-002X15-60A	298
PA-OSMLGLAXM3M-00		PA-VELLO-TJ3M-05	410	PA-ZASVELLO-LPP-05	406	PB-45-002X20-60A	296
	556, 558, 560, 562,	PA-VELLO-TJ3M-06	410	PA-ZASVELLO-LPP-06	406	PB-45-0010X3-60A	295
	564, 566, 576, 577	PA-VELLO-TJ3M-10	410	PA-ZASVELLO-LPP-10	406	PB-45-202X10-60A	296, 300
PA-OSMLGLAXMIC-00N		PA-VELLO-TJ3M-20M	410	PA-ZASVELLO-LPP-20M	406	PB-45-400MF-2X16-60A	294
	565, 569	PA-VELLO-TJ3M-21	410	PA-ZASVELLO-LPP-21	406	PB-45-450-2X20-60A	300
PA-OSMLGLAXMIC3M-00N		PA-ZASGLAX-00	570	PA-ZASVELO-CP-10	408	PB-45-450MF202X10-60A	301
	565, 569	PA-ZASGLAX-10	570	PA-ZASVELLO-CP-20M	408	PB-45-600MF-2X27-60A	303
PA-OSMLGLAXMK-00	566, 571	PA-ZASGLAX-20M	570	PA-ZAWGLAXDR-00	572, 573	PB-45-002010-60A	295
PA-OSMLGLAXMK3M-00	556,	PA-ZASGLAX-90	570	PA-ZGLAXKTOMZ-00	587	PB-45-MF2X15-60A	299
	558, 560, 562, 564	PA-ZASGLAXDR-00	572	PA-ZGLAXMNMKOMZ-00	586	PB-45-MF002X20-60A	297, 301
PA-OSMLGLAXMO-00	566	PA-ZASGLAXKT-00	584	PA-ZGLAXMNMKOMZ-10	586	PB-45-MF2X34-60A	302
PA-OSMLGLAXMO3M-00	556,	PA-ZASGLAXMIC-00	569	PA-ZGLAXMNMKOMZ-20M	586	PB-45-MF202X10-60A	297
	558, 560, 562, 564	PA-ZASGLAXMICNK-00	565	PA-ZGLAXNKKTOMZ-10	587	PB-45-MF342X17-60A	302
PA-OSMLGLAXSO-00	573	PA-ZASGLAXMNK-00	566	PA-ZGLAXNKKTOMZ-20M	587	PB-91024160V	305
PA-OSMLGLAXT-00	575	PA-ZASGLAXMNK-20M	566	PA-ZGLAXOMZ-00	586	PB-93004162601	305
PA-OSMLGLAXT3M-00	556,	PA-ZASGLAXMNK-90	566	PA-ZGLAXOMZ-10	586	PB-AS-600-1X15L-2X7L	304
	558, 560, 562, 564	PA-ZASGLAXMNKK-00	566	PA-ZGLAXOMZ-20M	586	PB-AS-600-1X15L-3X7L	304
PA-OSTRGLAX-00	567, 570,	PA-ZASGLAXMNKO-00	566	PB-0FPO18-250	134	PB-AS-600-2X15L	304
	572, 573, 574, 575,	PA-ZASGLAXMNKW-00	568	PB-0FPO18-300	134	PB-AS-600-2X15L-2X7L	304
	579, 584, 585	PA-ZASGLAXMNKW-10	568	PB-0FPO18-350	134	PB-AS-700-2X15L-2X7L	304
PA-OSTRGLAX3M-00	567, 570,	PA-ZASGLAXMNKW-20M	568	PB-0FPO18-400	134	PB-AS-800-2X15L-2X7L	304
	574, 575, 580, 581,	PA-ZASGLAXMNKW-90	568	PB-0FPO18-450	134	PB-AS-800-4X15L	304
	582, 583, 584	PA-ZASGLAXMW-00	571	PB-0FPO18-500	134	PB-AS-900-4X15L	304
PA-OSTRGLAXM-00	566,	PA-ZASGLAXMW-10	571	PB-0FPO18-550	134	PB-AXISPRO-KPL69-450-10169	
	568, 571, 578	PA-ZASGLAXMW-20M	571	PB-0FPO18-600	134	PB-AXISPRO-KPL69-450-60169	
PA-OSTRGLAXM3M-00	566,	PA-ZASGLAXMW-90	571	PB-0SHX-250-A	130	PB-AXISPRO-KPL69-500-10169	
	576, 577	PA-ZASGLAXMWK-00	571	PB-0SHX-270-A	130	PB-AXISPRO-KPL69-500-60169	
PA-ROZGLAX-53	572	PA-ZASGLAXNK-00	567	PB-0SHX-300-A	130	PB-AXISPRO-KPL250A	167
PA-ROZGLAXP-53	572	PA-ZASGLAXNKKT-00	575	PB-0SHX-350-A	130	PB-AXISPRO-KPL250A1	167
PA-SPRGLAXM-00	566, 568,	PA-ZASGLAXNKKT-10	575	PB-0SHX-400-A	130	PB-AXISPRO-KPL250B	167
	573	PA-ZASGLAXNKKT-20M	575	PB-0SHX-450-A	130	PB-AXISPRO-KPL250B1	167
PA-SPRGLAXMIC-00	565, 575	PA-ZASGLAXNKKT-90	575	PB-0SHX-500-A	130	PB-AXISPRO-KPL250C	168
PA-USZGLAX-00N	574	PA-ZASGLAXNKKT-00	575	PB-0SHX-550-A	130	PB-AXISPRO-KPL250C1	168
PA-USZGLAX-10N	574	PA-ZASGLAXRAD-00	573	PB-0SHX-600-A	130	PB-AXISPRO-KPL250D	168
PA-VELLO-C3M-05	408	PA-ZASVELLO-CN-05	408	PB-3D0FPO18-250-PRO	132	PB-AXISPRO-KPL250D1	168
PA-VELLO-C3M-06	408	PA-ZASVELLO-CN-06	408	PB-3D0FPO18-300-PRO	132	PB-AXISPRO-KPL300A	167
PA-VELLO-C3M-10	408	PA-ZASVELLO-CN-10	408	PB-3D0FPO18-350-PRO	132	PB-AXISPRO-KPL300A1	167
PA-VELLO-C3M-20M	408	PA-ZASVELLO-CN-20M	408	PB-3D0FPO18-400-PRO	132	PB-AXISPRO-KPL300B	167
PA-VELLO-C4M-05	408	PA-ZASVELLO-CN-21	408	PB-3D0FPO18-450-PRO	132	PB-AXISPRO-KPL300B1	167
PA-VELLO-C4M-06	408	PA-ZASVELLO-CP-05	408	PB-3D0FPO18-500-PRO	132	PB-AXISPRO-KPL300C	168
PA-VELLO-C4M-10	408	PA-ZASVELLO-CP-06	408	PB-3D0FPO18-550-PRO	132	PB-AXISPRO-KPL300C1	168
PA-VELLO-C4M-20M	408	PA-ZASVELLO-CP-21	408	PB-3D0FPO18-600-PRO	132	PB-AXISPRO-KPL300D	168
PA-VELLO-C4M-21	408	PA-ZASVELLO-LNL-05	406	PB-3D0SHX18-250-H	129	PB-AXISPRO-KPL300D1	168
PA-VELLO-L3M-05	406	PA-ZASVELLO-LNL-06	406	PB-3D0SHX18-300-H	129	PB-AXISPRO-KPL350A	167
PA-VELLO-L3M-06	406	PA-ZASVELLO-LNL-10	406	PB-3D0SHX18-300-PRO	128	PB-AXISPRO-KPL350A1	167
PA-VELLO-L3M-10	406	PA-ZASVELLO-LNL-20M	406	PB-3D0SHX18-350-H	129	PB-AXISPRO-KPL350B	167
PA-VELLO-L3M-20M	406	PA-ZASVELLO-LNL-21	406	PB-3D0SHX18-350-PRO	128	PB-AXISPRO-KPL350B1	167
PA-VELLO-L4M-05	406	PA-ZASVELLO-LNP-05	406	PB-3D0SHX18-400-H	129	PB-AXISPRO-KPL350C	168
PA-VELLO-L4M-06	406	PA-ZASVELLO-LNP-06	406	PB-3D0SHX18-400-PRO	128	PB-AXISPRO-KPL350C1	168



PB-AXISPRO-KPL350D	168	PB-AXISPRO-P20-KPL300D1171	PB-AXISPRO-RELKW500	175	PB-D-CONREL	207	
PB-AXISPRO-KPL350D1	168	PB-AXISPRO-P20-KPL350A 169	PB-AXISPRO-RELKW500-10	175	PB-D-CONREL-10	207	
PB-AXISPRO-KPL400A	167	PB-AXISPRO-P20-KPL350A1169	PB-AXISPRO-RELKW550	175	PB-D-CONREL-KW	192	
PB-AXISPRO-KPL400A1	167	PB-AXISPRO-P20-KPL350B 170	PB-AXISPRO-RELKW550-10	175	PB-D-CONREL-KW-10	192	
PB-AXISPRO-KPL400B	167	PB-AXISPRO-P20-KPL350B1170	PB-AXISPRO-SYNCHRO-P20		PB-D-D2R0-00	193, 211	
PB-AXISPRO-KPL400B1	167	PB-AXISPRO-P20-KPL350C 170		169, 170, 171	PB-D-D2R0-01	193, 211	
PB-AXISPRO-KPL400C	168	PB-AXISPRO-P20-KPL350C1170	PB-AXISPRO-SYNCHRO-P20-		PB-D-KPL68-450-10	213	
PB-AXISPRO-KPL400C1	168	PB-AXISPRO-P20-KPL350D 171	-MOC	169, 170, 171	PB-D-KPL68-450-80	213	
PB-AXISPRO-KPL400D	168	PB-AXISPRO-P20-KPL350D1171	PB-AXISPRO-WEWMOCA	171	PB-D-KPL68-500-10	213	
PB-AXISPRO-KPL400D1	168	PB-AXISPRO-P20-KPL400A 169	PB-AXISPRO-WEWMOCA1	171	PB-D-KPL68-500-80	213	
PB-AXISPRO-KPL450A	167	PB-AXISPRO-P20-KPL400A1169	PB-AXISPRO-WEWMOCB	172	PB-D-KPL250A	199	
PB-AXISPRO-KPL450A1	167	PB-AXISPRO-P20-KPL400B 170	PB-AXISPRO-WEWMOCB1	172	PB-D-KPL250A1	199	
PB-AXISPRO-KPL450B	167	PB-AXISPRO-P20-KPL400B1170	PB-AXISPRO-WEWMOC	172	PB-D-KPL250B	200	
PB-AXISPRO-KPL450B1	167	PB-AXISPRO-P20-KPL400C 170	PB-AXISPRO-WEWMOC1	172	PB-D-KPL250B1	200	
PB-AXISPRO-KPL450C	168	PB-AXISPRO-P20-KPL400C1170	PB-AXISPRO-WEWMOC	173	PB-D-KPL250C	200	
PB-AXISPRO-KPL450C1	168	PB-AXISPRO-P20-KPL400D 171	PB-AXISPRO-WEWMOC1	173	PB-D-KPL250C1	200	
PB-AXISPRO-KPL450D	168	PB-AXISPRO-P20-KPL400D1171	PB-AXISPRO-ZESWEW-A1		PB-D-KPL300A	199	
PB-AXISPRO-KPL450D1	168	PB-AXISPRO-P20-KPL450A 169	AXISPRO	173	PB-D-KPL300A1	199	
PB-AXISPRO-KPL500A	167	PB-AXISPRO-P20-KPL450A1169	PB-AXISPRO-ZESWEW-A		PB-D-KPL300B	200	
PB-AXISPRO-KPL500A1	167	PB-AXISPRO-P20-KPL450B 170	AXISPRO	173	PB-D-KPL300B1	200	
PB-AXISPRO-KPL500B	167	PB-AXISPRO-P20-KPL450B1170	PB-AXISPRO-ZESWEW-B1		PB-D-KPL300C	200	
PB-AXISPRO-KPL500B1	167	PB-AXISPRO-P20-KPL450C 170	AXISPRO	174	PB-D-KPL300C1	200	
PB-AXISPRO-KPL500C	168	PB-AXISPRO-P20-KPL450C1170	PB-AXISPRO-ZESWEW-B		PB-D-KPL350A	199	
PB-AXISPRO-KPL500C1	168	PB-AXISPRO-P20-KPL450D 171	AXISPRO	174	PB-D-KPL350A1	199	
PB-AXISPRO-KPL500D	168	PB-AXISPRO-P20-KPL450D1171	PB-AXISPRO-ZESWEW-C1		PB-D-KPL350B	200	
PB-AXISPRO-KPL500D1	168	PB-AXISPRO-P20-KPL500A 169	AXISPRO	174	PB-D-KPL350B1	200	
PB-AXISPRO-KPL550A	167	PB-AXISPRO-P20-KPL500A1169	PB-AXISPRO-ZESWEW-C		PB-D-KPL350C	200	
PB-AXISPRO-KPL550A1	167	PB-AXISPRO-P20-KPL500B 170	AXISPRO	174	PB-D-KPL350C1	200	
PB-AXISPRO-KPL550B	167	PB-AXISPRO-P20-KPL500B1170	PB-AXISPRO-ZESWEW-D1		PB-D-KPL400A	199	
PB-AXISPRO-KPL550B1	167	PB-AXISPRO-P20-KPL500C 170	AXISPRO	175	PB-D-KPL400A1	199	
PB-AXISPRO-KPL550C	168	PB-AXISPRO-P20-KPL500C1170	PB-AXISPRO-ZESWEW-D		PB-D-KPL400B	200	
PB-AXISPRO-KPL550C1	168	PB-AXISPRO-P20-KPL500D 171	AXISPRO	175	PB-D-KPL400B1	200	
PB-AXISPRO-KPL550D	168	PB-AXISPRO-P20-KPL500D1171	PB-AXISPRO-ZNACZ-FRONT175		PB-D-KPL400C	200	
PB-AXISPRO-KPL550D1	168	PB-AXISPRO-P20-KPL550A 169	PB-D-BXSIDE45B	208	PB-D-KPL400C1	200	
PB-AXISPRO-KPL600A	167	PB-AXISPRO-P20-KPL550A1169	PB-D-BXSIDE45B-10	208	PB-D-KPL450A	199	
PB-AXISPRO-KPL600A1	167	PB-AXISPRO-P20-KPL550B 170	PB-D-BXSIDE45C	209	PB-D-KPL450A1	199	
PB-AXISPRO-KPL600B	167	PB-AXISPRO-P20-KPL550B1170	PB-D-BXSIDE45C-10	209	PB-D-KPL450B	200	
PB-AXISPRO-KPL600B1	167	PB-AXISPRO-P20-KPL550C 170	PB-D-BXSIDE50B	208	PB-D-KPL450B1	200	
PB-AXISPRO-KPL600C	168	PB-AXISPRO-P20-KPL550C1170	PB-D-BXSIDE50B-10	208	PB-D-KPL450C	200	
PB-AXISPRO-KPL600C1	168	PB-AXISPRO-P20-KPL550D 171	PB-D-BXSIDE50C	209	PB-D-KPL450C1	200	
PB-AXISPRO-KPL600D	168	PB-AXISPRO-P20-KPL550D1171	PB-D-BXSIDE50C-10	209	PB-D-KPL500A	199	
PB-AXISPRO-KPL600D1	168	PB-AXISPRO-P20-KPL600A 169	PB-D-BXSIDEKW25C	194	PB-D-KPL500A1	199	
PB-AXISPRO-P20-KPL250A 169		PB-AXISPRO-P20-KPL600A1169	PB-D-BXSIDEKW25C-10	194	PB-D-KPL500B	200	
PB-AXISPRO-P20-KPL250A1169		PB-AXISPRO-P20-KPL600B 170	PB-D-BXSIDEKW30C	194	PB-D-KPL500B1	200	
PB-AXISPRO-P20-KPL250B 170		PB-AXISPRO-P20-KPL600B1170	PB-D-BXSIDEKW30C-10	194	PB-D-KPL500C	200	
PB-AXISPRO-P20-KPL250B1170		PB-AXISPRO-P20-KPL600C 170	PB-D-BXSIDEKW35C	194	PB-D-KPL500C1	200	
PB-AXISPRO-P20-KPL250C 170		PB-AXISPRO-P20-KPL600C1170	PB-D-BXSIDEKW35C-10	194	PB-D-KPL550A	199	
PB-AXISPRO-P20-KPL250C1170		PB-AXISPRO-P20-KPL600D 171	PB-D-BXSIDEKW40C	194	PB-D-KPL550A1	199	
PB-AXISPRO-P20-KPL250D 171		PB-AXISPRO-P20-KPL600D1171	PB-D-BXSIDEKW40C-10	194	PB-D-KPL550B	200	
PB-AXISPRO-P20-KPL250D1171		PB-AXISPRO-RELKW300	175	PB-D-BXSIDEKW45C	194	PB-D-KPL550B1	200
PB-AXISPRO-P20-KPL300A 169		PB-AXISPRO-RELKW300-10	175	PB-D-BXSIDEKW45C-10	194	PB-D-KPL550C	200
PB-AXISPRO-P20-KPL300A1169		PB-AXISPRO-RELKW350	175	PB-D-BXSIDEKW50C	194	PB-D-KPL550C1	200
PB-AXISPRO-P20-KPL300B 170		PB-AXISPRO-RELKW350-10	175	PB-D-BXSIDEKW50C-10	194	PB-D-LR-00-0	206
PB-AXISPRO-P20-KPL300B1170		PB-AXISPRO-RELKW400	175	PB-D-BXSIDEKW55C	194	PB-D-LR-00-10	206
PB-AXISPRO-P20-KPL300C 170		PB-AXISPRO-RELKW400-10	175	PB-D-BXSIDEKW55C-10	194	PB-D-MATRYCA	197, 211
PB-AXISPRO-P20-KPL300C1170		PB-AXISPRO-RELKW450	175	PB-D-CONBSXSID	207	PB-D-MBSTAB-00	213
PB-AXISPRO-P20-KPL300D 171		PB-AXISPRO-RELKW450-10	175	PB-D-CONBSXSID-10	207	PB-D-MHG04	212

PB-D-MHG04-KW	196	PB-D-WEWMOCC	203	PB-KW-KPL350C	188	PB-MBPRO-KPL500A1	177, 178
PB-D-N2R0-00	195, 209	PB-D-WEWMOCC1	203	PB-KW-KPL350C1	188	PB-MBPRO-KPL500B	177
PB-D-N2R0-01	195, 209	PB-D-WEWMOCC-KW	190	PB-KW-KPL400A	187	PB-MBPRO-KPL500B1	177
PB-D-P20250A	199	PB-D-WEWMOCC-KW-10	190	PB-KW-KPL400A1	187	PB-MBPRO-KPL500C	178
PB-D-P20300A	199	PB-D-WEWORG-A	204	PB-KW-KPL400B	187	PB-MBPRO-KPL500C1	178
PB-D-P20300C	200	PB-D-WEWORG-A-10	204	PB-KW-KPL400B1	187	PB-MBPRO-KPL550A	177, 178
PB-D-P20350A	199	PB-D-WEWORG-B	204	PB-KW-KPL400C	188	PB-MBPRO-KPL550A1	177, 178
PB-D-P20350C	200	PB-D-WEWORG-B-10	204	PB-KW-KPL400C1	188	PB-MBPRO-KPL550B	177
PB-D-P20400A	199	PB-D-WEWORGKW-A	191	PB-KW-KPL450A	187	PB-MBPRO-KPL550B1	177
PB-D-P20400C	200	PB-D-WEWORGKW-A-10	191	PB-KW-KPL450A1	187	PB-MBPRO-KPL550C	178
PB-D-P20450A	199	PB-D-WEWORGKW-B	192	PB-KW-KPL450B	187	PB-MBPRO-KPL550C1	178
PB-D-P20450C	200	PB-D-WEWORGKW-B-10	192	PB-KW-KPL450B1	187	PB-MBPRO-MOCRELTYL	183
PB-D-P20500A	199	PB-D-WEWSZKLC	202	PB-KW-KPL450C	188	PB-MBPRO-MOCRELTYL1	183
PB-D-P20500C	200	PB-D-WEWSZKLC-10	202	PB-KW-KPL450C1	188	PB-MBPRO-RELKW300178, 179	
PB-D-P20550C	200	PB-D-ZESWEW-C	203	PB-KW-KPL500A	187	PB-MBPRO-RELKW300-10	178, 179
PB-D-P20STAB	165	PB-D-ZESWEW-C-10	203	PB-KW-KPL500A1	187		
PB-D-PRZEGLP	208	PB-D-ZESWEWKW-C	190	PB-KW-KPL500B	187	PB-MBPRO-RELKW350178, 179	
PB-D-PRZEGLP-10	208	PB-D-ZESWEWKW-C-10	190	PB-KW-KPL500B1	187	PB-MBPRO-RELKW350-10	178, 179
PB-D-PRZEGLP-KW	193	PB-D-ZLE-450	214	PB-KW-KPL500C	188		
PB-D-PRZEGLP-KW-10	193	PB-D-ZLE-500	214	PB-KW-KPL500C1	188	PB-MBPRO-RELKW400178, 179	
PB-D-REL450-10	201	PB-D-ZNACZ-0	197, 212	PB-KW-KPL550A	187	PB-MBPRO-RELKW400-10	178, 179
PB-D-REL500-10	201	PB-D-ZR-00-0	205	PB-KW-KPL550A1	187		
PB-D-REL550-10	201	PB-D-ZR-00-10	205	PB-KW-KPL550B	187	PB-MBPRO-RELKW450178, 179	
PB-D-REL2500	201	PB-D-ZR-KW-00	191	PB-KW-KPL550B1	187	PB-MBPRO-RELKW450-10	178, 179
PB-D-REL3000	201	PB-D-ZR-KW-10	191	PB-KW-KPL550C	188		
PB-D-REL3500	201	PB-G10HX300-H	135	PB-KW-KPL550C1	188	PB-MBPRO-RELKW500178, 179	
PB-D-REL4000	201	PB-G10HX-350	135	PB-KW-KPL600A	187	PB-MBPRO-RELKW500-10	178, 179
PB-D-REL4500	201	PB-G10HX-450	135	PB-KW-KPL600A1	187		
PB-D-REL5000	201	PB-G10HX-500	135	PB-KW-KPL600B	187	PB-MBPRO-RELKW550178, 179	
PB-D-REL5500	201	PB-G10HX-550	135	PB-KW-KPL600B1	187	PB-MBPRO-RELKW550-10	178, 179
PB-D-RELCOV	206	PB-GCHX18-300-H	131	PB-KW-KPL600C	188		
PB-D-RELCOV-10	206	PB-GCHX18-350-H	131	PB-KW-KPL600C1	188	PB-MBPRO-WEWMOCA	179
PB-D-RELKW350	188	PB-GCHX18-400-H	131	PB-MBPRO-KPL300A	177, 178	PB-MBPRO-WEWMOCA1	179
PB-D-RELKW350-10	188	PB-GCHX18-450-H	131	PB-MBPRO-KPL300A1	177, 178	PB-MBPRO-WEWMOCB	180
PB-D-RELKW400	188	PB-GCHX18-500-H	131	PB-MBPRO-KPL300B	177	PB-MBPRO-WEWMOCCB1	180
PB-D-RELKW400-10	188	PB-GCHX18-550-H	131	PB-MBPRO-KPL300B1	177	PB-MBPRO-WEWMOCC	180
PB-D-RELKW450	188	PB-KO450BO	314	PB-MBPRO-KPL300C	178	PB-MBPRO-WEWMOCC1	180
PB-D-RELKW450-10	188	PB-KO450BO-E-L	314	PB-MBPRO-KPL300C1	178	PB-MBPRO-WEWMOCCD	181
PB-D-RELKW500	188	PB-KO450BO-E-R	314	PB-MBPRO-KPL350A	177, 178	PB-MBPRO-WEWMOCCD1	181
PB-D-RELKW500-10	188	PB-KO450BO-L1	312	PB-MBPRO-KPL350A1	177, 178	PB-MBPRO-ZESWEW-A	184
PB-D-RELKW550	188	PB-KO450BO-R1	312	PB-MBPRO-KPL350B	177	PB-MBPRO-ZESWEW-A1	184
PB-D-RELKW550-10	188	PB-KW-KPL250A	187	PB-MBPRO-KPL350B1	177	PB-MBPRO-ZESWEW-B	184
PB-D-S2R0-00	195, 210	PB-KW-KPL250A1	187	PB-MBPRO-KPL350C	178	PB-MBPRO-ZESWEW-B1	184
PB-D-S2R0-01	195, 210	PB-KW-KPL250B	187	PB-MBPRO-KPL350C1	178	PB-MBPRO-ZESWEW-C	185
PB-D-UCHWEW	205	PB-KW-KPL250B1	187	PB-MBPRO-KPL400A	177, 178	PB-MBPRO-ZESWEW-C1	185
PB-D-UCHWEW-10	205	PB-KW-KPL250C	188	PB-MBPRO-KPL400A1	177, 178	PB-MBPRO-ZESWEW-D	185
PB-D-ULE-500	214	PB-KW-KPL250C1	188	PB-MBPRO-KPL400B	177	PB-MBPRO-ZESWEW-D1	185
PB-D-W2R0-00	196, 210	PB-KW-KPL300A	187	PB-MBPRO-KPL400B1	177	PB-MBPRO-ZLATYLA	181
PB-D-W2R0-01	196, 210	PB-KW-KPL300A1	187	PB-MBPRO-KPL400C	178	PB-MBPRO-ZLATYLA1	181
PB-D-WEWMOCA	201	PB-KW-KPL300B	187	PB-MBPRO-KPL400C1	178	PB-MBPRO-ZLATYLB	182
PB-D-WEWMOCA1	201	PB-KW-KPL300B1	187	PB-MBPRO-KPL450A	177, 178	PB-MBPRO-ZLATYLB1	182
PB-D-WEWMOCA-KW	189	PB-KW-KPL300C	188	PB-MBPRO-KPL450A1	177, 178	PB-MBPRO-ZLATYLC	182
PB-D-WEWMOCA-KW-10	189	PB-KW-KPL300C1	188	PB-MBPRO-KPL450B	177	PB-MBPRO-ZLATYLC1	182
PB-D-WEWMOCB	202	PB-KW-KPL350A	187	PB-MBPRO-KPL450B1	177	PB-MBPRO-ZLATYLD	178, 183
PB-D-WEWMOCB1	202	PB-KW-KPL350A1	187	PB-MBPRO-KPL450C	178	PB-MBPRO-ZLATYLD1	178, 183
PB-D-WEWMOCB-KW	189	PB-KW-KPL350B	187	PB-MBPRO-KPL450C1	178	PB-SYNCHROP20-PRO	132
PB-D-WEWMOCB-KW-10	189	PB-KW-KPL350B1	187	PB-MBPRO-KPL500A	177, 178	PB-SYNCHROP20-PRO-MOC132	

PB-SZABLON-AXIS-MB	215	PD-LIFT-P20-STRONG-		PK-0-H35-3000L	154	PK-0H45450HK	150
PB-SZABLON-AXIS-MBPRO216		-PLUS-80	114	PK-0-H35-3500	153	PK-0H45500GX1	149
PB-WSPCOK	133	PD-MDLIFT-P1-D	124	PK-0H35-3500	152	PK-0H45500GX2-A	151
PD-ECGDL-060	126	PD-MDLIFT-P2-D	125	PK-0-H35-3500L	154	PK-0H45500HK	150
PD-ECGDL-080	126	PD-MD-ZB-01-KPL	107	PK-0-H35-4000	153	PK-0H45550GX1	149
PD-ECGDL-150	126	PD-MD-ZB-04-KPL	107	PK-0H35-4000	152	PK-0H45550GX2-A	151
PD-G0050-N02	118	PD-MINILIFTNEW-LIGHT	115	PK-0-H35-4000L	154	PK-0H45550HK	150
PD-G0050-N03	119	PD-MINILIFTNEW-LIGHT-20115		PK-0-H35-4500	153	PK-0H45600GX1	149
PD-G0060-N02	118	PD-MINILIFTNEW-MEDIUM	115	PK-0H35-4500	152	PK-0H45600GX2-A	151
PD-G0060-N03	119	PD-MINILIFTNEW-MEDIUM-20		PK-0-H35-4500L	154	PK-0H45600HK	150
PD-G0080-N02	118	115		PK-0-H35-5000	153	PK-0H45650GX1	149
PD-G0080-N03	119	PD-MINILIFTNEW-STRONG	115	PK-0H35-5000	152	PK-0H45650GX2-A	151
PD-G0100-N02	118	PD-MINILIFTNEW-STRONG-20		PK-0-H35-5000L	154	PK-0H45650HK	150
PD-G0100-N03	119	115		PK-0-H45-250	145	PK-0H45700GX1	149
PD-G0120-N02	118	PD-PD000-001	122	PK-0-H45-300	145	PK-0H45700GX2-A	151
PD-G0120-N03	119	PD-PD000-001B	123	PK-0-H45-350	145	PK-0H45700HK	150
PD-G0150-N02	118	PG-AL4560-20	292	PK-0-H45-400	145	PK-0H45750HK	150
PD-G0150-N03	119	PG-AL6083-20	292	PK-0-H45-450	145	PK-L-H45-250-A	142
PD-G60160-02	120	PG-AL8311520	292	PK-0-H45-500	145	PK-L-H45-250-B	140
PD-G80160-02	120	PG-GA4560-10	291	PK-0-H45-550	145	PK-L-H45-300-A	142
PD-GAM050-N02	116	PG-GA4560-20	291	PK-0-H45-600	145	PK-L-H45-300-B	140
PD-GAM050-N10	116	PG-GA6083-10	291	PK-0-H45-700	145	PK-L-H45-300-GX	143
PD-GAM050-N60	116	PG-GA6083-20	291	PK-0-H53-300	136	PK-L-H45-350-A	142
PD-GAM060-N02	116	PG-GA83115-10	291	PK-0-H53-350	136	PK-L-H45-350-B	140
PD-GAM060-N10	116	PG-GA8311520	291	PK-0-H53-400	136	PK-L-H45-350-GX	143
PD-GAM060-N60	116	PG-ST4560-10	292	PK-0-H53-450	136	PK-L-H45-400-A	142
PD-GAM080-N02	116	PG-ST4560-10A	278	PK-0-H53-500	136	PK-L-H45-400-B	140
PD-GAM080-N10	116	PG-ST4560-20	292	PK-0-H53-550	136	PK-L-H45-400-GX	143
PD-GAM080-N60	116	PG-ST4560-60	278	PK-0-H53-600	136	PK-L-H45-450-A	142
PD-GAM100-N02	116	PG-ST6083-10	292	PK-0-H53-650	136	PK-L-H45-450-B	140
PD-GAM100-N10	116	PG-ST6083-10A	278	PK-0-H53-700	136	PK-L-H45-450-GX	143
PD-GAM100-N60	116	PG-ST6083-20	292	PK-0-H53-750	136	PK-L-H45-500-A	142
PD-GAM120-N02	116	PG-ST6083-60	278	PK-0-H53-800	136	PK-L-H45-500-B	140
PD-GAM120-N10	116	PG-ST83115-10	292	PK-0-H53-900	136	PK-L-H45-500-GX	143
PD-GAM120-N60	116	PG-ST83115-10A	278	PK-0-H53-1000	136	PK-L-H45-550-A	142
PD-GAM150-N02	116	PG-ST83115-60	278	PK-0-H53-1100	136	PK-L-H45-550-B	140
PD-GAM150-N10	116	PG-ST8311520	292	PK-0H17182XP	159	PK-L-H45-550-GX	143
PD-GAM150-N60	116	PK-0-000-027	158	PK-0H17214XP	159	PK-L-H45-600-A	142
PD-GPD01-001	121	PK-0H27-3000	157	PK-0H17246XP	159	PK-L-H45-600-B	140
PD-GPD02-002	121	PK-0H27-3500	157	PK-0H17278XP	159	PK-L-H45-600-GX	143
PD-GPD03-005	121	PK-0H27-4000	157	PK-0H17310XP	159	PK-L-P20-H45-300	138
PD-LIFTNEW-LIGHT-10	114	PK-0H27-4500	157	PK-0H17342XP	159	PK-L-P20-H45-350	138
PD-LIFTNEW-LIGHT-80	114	PK-0H27-5000	157	PK-0H17406XP	159	PK-L-P20-H45-400	138
PD-LIFTNEW-MEDIUM-10	114	PK-0H30-2500	155	PK-0H17438XP	159	PK-L-P20-H45-450	138
PD-LIFTNEW-MEDIUM-80	114	PK-0H30-2500-A	156	PK-0H45250GX1	149	PK-L-P20-H45-500	138
PD-LIFTNEW-STRONG-10	114	PK-0H30-3000	155	PK-0H45250HK	150	PK-L-P20-H45-550	138
PD-LIFTNEW-STRONG-80	114	PK-0H30-3000-A	156	PK-0H45300GX1	149	PK-L-P20-H45-600	138
PD-LIFTNEW-STRONG-		PK-0H30-3500	155	PK-0H45300GX2-A	151	PK-L-P20-H45-700	138
-PLUS-10	114	PK-0H30-3500-A	156	PK-0H45300HK	150	PK-P-H45-300-GX	148
PD-LIFT-P20-LIGHT-10	114	PK-0H30-4000	155	PK-0H45300GX1	149	PK-P-H45-350-GX	148
PD-LIFT-P20-LIGHT-80	114	PK-0H30-4000-A	156	PK-0H45350GX2-A	151	PK-P-H45-400-GX	148
PD-LIFT-P20-MEDIUM-10	114	PK-0H30-4500	155	PK-0H45350HK	150	PK-P-H45-450-GX	148
PD-LIFT-P20-MEDIUM-80	114	PK-0-H35-2500	153	PK-0H45400GX1	149	PK-P-H45-500-GX	148
PD-LIFT-P20-STRONG-10	114	PK-0H35-2500	152	PK-0H45400GX2-A	151	PK-P-H45-550-GX	148
PD-LIFT-P20-STRONG-80	114	PK-0-H35-2500L	154	PK-0H45400HK	150	PK-P-H45-600-GX	148
PD-LIFT-P20-STRONG-		PK-0-H35-3000	153	PK-0H45450GX1	149	PK-PRO-H45-250	146
-PLUS-10	114	PK-0H35-3000	152	PK-0H45450GX2-A	151	PK-PRO-H45-300	146

PK-PRO-H45-350	146	PP-00GS04-06	223	PR-OB-350-18-Z	161	RS-304224-02	390
PK-PRO-H45-400	146	PP-BAR-20M	462	PR-OB-400-10	160	RS-304224-05	390
PK-PRO-H45-450	146	PP-BELT-20M	456	PR-OB-400-10-Z	161	RS-304224-06	390
PK-PRO-H45-500	146	PP-DP0105-06	222	PR-OB-400-18	160	RS-304224-14	390
PK-PRO-H45-550	146	PP-DP0105-01	222	PR-OB-450-10	160	RS-336256-01	390
PK-PRO-H45-600	146	PP-DP0105-02	222	PR-OB-450-10-Z	161	RS-336256-02	390
PK-PRO-H45-650	146	PP-DP0105-05	222	PR-OB-450-18	160	RS-336256-05	390
PK-S-H45-250	144	PP-FLAT-20M	456	PR-OB-450-80-Z	161	RS-336256-06	390
PK-S-H45-300	144	PP-GALA-20M	458	PR-OB-500-10	160	RS-336256-14	390
PK-S-H45-350	144	PP-GINO-20M	458	PR-OB-500-18	160	RS-368288-01	390
PK-S-H45-400	144	PP-GL-A48-01	224	PR-OB-550-10	160	RS-368288-02	390
PK-S-H45-450	144	PP-GL-B48-01	224	PR-OB-550-18	160	RS-368288-05	390
PK-S-H45-500	144	PP-GL-CGP-01	225	PR-OB-600-10	160	RS-368288-06	390
PK-S-H45-550	144	PP-GL-DR5-01	232	PR-OB-600-18	160	RS-368288-14	390
PK-S-H45-600	144	PP-GL-E410-01	225	PU-KEY027-20	320	RS-400320-01	390
PK-S-H45-650	144	PP-HS0006-01	227	PU-KEY027-60	320	RS-400320-02	390
PK-S-H45-700	144	PP-HS2710-01	228	PU-KEYM27-20	320	RS-400320-05	390
PM-LBFI60-01	325	PP-INGRID-20M	460	PU-KEYM27-60	320	RS-400320-06	390
PM-LBFI60-02	325	PP-LUK-00-01	235	PU-PKO-00-20	321	RS-400320-14	390
PM-LBFI60-05	325	PP-LUK-00-02	235	PU-PKO-00-60	321	RS-SZ-400-10	164
PM-LBFI60-06	325	PP-LUK-00-05	235	PZ-HCSL3D-H0-BEO	71	RS-SZ-450-10	164
PM-LBFI60-20M	325	PP-MP0055-01	221	PZ-HCSL-H0-BEO	71	RS-SZ-500-10	164
PM-LBFI80-01	325	PP-MP0055-02	221	PZ-HCSL-H0-M5	71	RS-TRIES-96-06	392
PM-LBFI80-02	325	PP-MP0055-05	221	PZ-HCSL-H0-ZEO	71	RS-TRIES-128-06	392
PM-LBFI80-05	325	PP-MP0055-06	221			RS-TRIES-160-06	392
PM-LBFI80-06	325	PP-NEO-20M	460	<b>R</b>		RS-TRIES-192-06	392
PM-LBFI80-20M	325	PP-NW09X90B	234	RR-161030H01	255	RS-TRIES-256-06	392
PM-NAR1004-10	242	PP-NW10X100B	234	RR-161230H01	255	RS-TRIES-320-06	392
PM-NAR1004-11	242	PP-NW10X145B	234	RR-250730H01	255		
PM-NAR1004-19	242	PP-NW12X120B	234	RR-250830H01	255	<b>S</b>	
PM-PFMH50-24	250	PP-NW14X120B	234	RR-250930H01	255	SB-A60x72-20M	499
PM-PFMH50-25	250	PP-NW14X140B	234	RR-251030H01	255	SB-A60X72-80	499
PM-PFMH51-10	250	PP-NW14X165B	234	RR-401230H01	255	SZ-005-00-01-AT	247
PM-PFMH55-25	250	PP-PMONT0D-22	241	RR-501030H01	255	SZ-005-00-01T	247
PM-PFMH61-10	250	PP-PMONT0M-01	240	RR-501230H01	255	SZ-008-00-01-AT	247
PM-PFMH64-25	250	PP-PMONT0M-07	240	RR-CH-OW-000	253	SZ-008-00-01T	247
PM-PLFI60-05	325	PP-PMONT0M-08	240	RS-156096-01	390	<b>U</b>	
PM-PLFI60-10	325	PP-PMONT0M-22	240	RS-156096-02	390	UA-00-313128	362
PM-PLFI60-20	325	PP-ROD-20M	462	RS-156096-05	390	UA-00-313160	362
PM-PLFI60-30	325	PP-S0L003-01T	226	RS-156096-06	390	UA-00-313192	362
PM-PLFI60-43	325	PP-S0L012-01T	227	RS-156096-14	390	UA-00-319096	360
PM-PLFI60-45	325	PP-SMART-000	234	RS-188128-01	390	UA-00-319128	360
PM-PLFI60-47	325	PP-SP0075-01	221	RS-188128-02	390	UA-00-319160	360
PM-PLFI60-49	325	PP-SP0075-02	221	RS-188128-05	390	UA-00-326096-05	393
PM-PLFI60-50	325	PP-SP0075-05	221	RS-188128-06	390	UA-00-326096-20M	393
PM-PLFI60-51	325	PP-SP0075-06	221	RS-188128-14	390	UA-00-326128-05	393
PP-00GS02-01	222	PP-SPL001-01	233	RS-220160-01	390	UA-00-326128-20M	393
PP-00GS02-02	222	PP-TREE-20M	463	RS-220160-02	390	UA-00-326160	393
PP-00GS02-05	222	PP-WIRE-20M	463	RS-220160-05	390	UA-00-326160-20M	393
PP-00GS02-06	222	PR-OB-250-10	160	RS-220160-06	390	UA-00-337096	381
PP-00GS03-01	223	PR-OB-250-18	160	RS-220160-14	390	UA-00-337096-20M	381
PP-00GS03-02	223	PR-OB-300-10	160	RS-272192-01	390	UA-00-337128	381
PP-00GS03-05	223	PR-OB-300-10-Z	161	RS-272192-02	390	UA-00-337128-20M	381
PP-00GS03-06	223	PR-OB-300-18	160	RS-272192-05	390	UA-00-337160	381
PP-00GS04-01	223	PR-OB-350-10	160	RS-272192-06	390	UA-00-337160-20M	381
PP-00GS04-02	223	PR-OB-350-10-Z	161	RS-272192-14	390	UA-00-337192	381
PP-00GS04-05	223	PR-OB-350-18	160	RS-304224-01	390		

UA-00-337192-20M	381	UA-B0-337192	361	UA-HEXI-128-10M	398	UA-PICADO-256-296-05	402
UA-00-337224	381	UA-B0-337224	361	UA-HEXI-128-20M	398	UA-PICADO-256-296-18	402
UA-00-337224-20M	381	UA-B0-337256	361	UA-HEXI-160-01	398	UA-PICADO-256-296-20M	402
UA-00-337256	381	UA-B0-337320	361	UA-HEXI-160-05	398	UA-PICADO-256-596-01	402
UA-00-337256-20M	381	UA-EXTEND-1200-10M	340	UA-HEXI-160-10M	398	UA-PICADO-256-596-05	402
UA-00-337320	381	UA-EXTEND-1200-20M	340	UA-HEXI-160-18	398	UA-PICADO-256-596-18	402
UA-00-337320-20M	381	UA-EXTEND-1200-22	340	UA-HEXI-160-20M	398	UA-PICADO-256-596-20M	402
UA-00-338128	381	UA-HEXA-32-01	400	UA-HEXI-160-60	398	UA-PICADO-320-396-01	402
UA-00-338160	381	UA-HEXA-32-05	400	UA-HEXI192-01	398	UA-PICADO-320-396-05	402
UA-00-340128	382	UA-HEXA-32-10M	400	UA-HEXI192-05	398	UA-PICADO-320-396-18	402
UA-00-340160	382	UA-HEXA-32-18	400	UA-HEXI192-10M	398	UA-PICADO-320-396-20M	402
UA-00-340192	382	UA-HEXA-32-20M	400	UA-HEXI192-18	398	UA-PICADO-352-596-01	402
UA-00-340224	382	UA-HEXA-32-22	400	UA-HEXI192-20M	398	UA-PICADO-352-796-05	402
UA-00-340320	382	UA-HEXA-96-01	400	UA-HEXI192-60	398	UA-PICADO-352-796-18	402
UA-00-347128	382	UA-HEXA-96-05	400	UA-HEXI-256-01	398	UA-PICADO-352-796-20M	402
UA-00-347160	382	UA-HEXA-96-10M	400	UA-HEXI-256-05	398	UA-STRUCTURE-128-20M	379
UA-00-347192	382	UA-HEXA-96-18	400	UA-HEXI-256-10M	398	UA-STRUCTURE-192-20M	379
UA-00-347224	382	UA-HEXA-96-20M	400	UA-HEXI-256-20M	398	UA-TREX-32-50-05	403
UA-00-347256	382	UA-HEXA-96-22	400	UA-HEXI-290-18	398	UA-TREX-32-50-20M	403
UA-00-347320	382	UA-HEXA-160-01	400	UA-HEXI-290-60	398	UA-TREX-96-150-05	403
UA-01-326096-V1	393	UA-HEXA-160-05	400	UA-HEXI-320-01	398	UA-TREX-96-150-20M	403
UA-01-326128-V1	393	UA-HEXA-160-10M	400	UA-HEXI-320-05	398	UA-TREX-224-250-05	403
UA-01-326160	393	UA-HEXA-160-20M	400	UA-HEXI-320-10M	398	UA-TREX-224-250-20M	403
UA-18-128146	361	UA-HEXA-160-22	400	UA-HEXI-320-20M	398	UA-TREX-320-350-05	403
UA-18-160178	361	UA-HEXA-192-01	400	UA-HEXI-360-18	398	UA-TREX-320-350-20M	403
UA-18-192210	361	UA-HEXA-192-05	400	UA-HEXI-360-60	398	UA-TREX-3500-05	403
UA-18-224242	361	UA-HEXA-192-10M	400	UA-HEXI-3500-05	398	UA-TREX-3500-20M	403
UA-18-256274	361	UA-HEXA-192-18	400	UA-HEXI-3500-20M	398	UM-BLOCK-CZ	436, 455
UA-18-320338	361	UA-HEXA-192-20M	400	UA-LIND-150-128-01	397	UM-BLOCK-NB	436
UA-ARS096-20	352	UA-HEXA-256-01	400	UA-LIND-150-128-05	397	UM-BLOCK-ZL	436
UA-ARS128-20	352	UA-HEXA-256-05	400	UA-LIND-150-128-18	397	UM-BUTTON-NB	436
UA-ARS160-20	352	UA-HEXA-256-10M	400	UA-LIND-150-128-20M	397	UM-BUTTON-SZ	436
UA-ARS192-20	352	UA-HEXA-256-20M	400	UA-LIND-224-496-01	397	UM-CLOUD-NB	436
UA-ARS224-20	352	UA-HEXA-256-22	400	UA-LIND-224-496-05	397	UM-CLOUD-SZ	436
UA-ARS256-20	352	UA-HEXA-320-01	400	UA-LIND-224-496-18	397	UM-CROWN-RZ	436
UA-ARS320-20	352	UA-HEXA-320-05	400	UA-LIND-224-496-20M	397	UM-FLAMING-RZ	436
UA-ARSG30-20	352	UA-HEXA-320-10M	400	UA-LIND-256-296-01	397	UM-FLAMING-SZ	436
UA-B0-311096	360	UA-HEXA-320-20M	400	UA-LIND-256-296-05	397	UM-HEART-RZ	436
UA-B0-311096-20M	360	UA-HEXA-320-22	400	UA-LIND-256-296-18	397	UM-KID-C-001	438
UA-B0-311128	360	UA-HEXA-1200-05	341	UA-LIND-256-296-20M	397	UM-KID-D-001	438
UA-B0-311128-20M	360	UA-HEXA-1200-10M	341	UA-LIND-256-596-01	397	UM-KID-E-001	438
UA-B0-311160	360	UA-HEXA-1200-20M	341	UA-LIND-256-596-05	397	UM-KID-P-001	438
UA-B0-311160-20M	360	UA-HEXA-1200-22	341	UA-LIND-256-596-18	397	UM-KID-Q-001	438
UA-B0-311192	360	UA-HEXI-01	398	UA-LIND-256-596-20M	397	UM-KID-U-001	438
UA-B0-311192-20M	360	UA-HEXI-05	398	UA-LIND-320-396-01	397	UM-KID-W-001	439
UA-B0-311224	360	UA-HEXI-10M	398	UA-LIND-320-396-05	397	UM-KID-X-001	439
UA-B0-311224-20M	360	UA-HEXI-18	398	UA-LIND-320-396-18	397	UM-KID-Z-001	439
UA-B0-311256	360	UA-HEXI-20M	398	UA-LIND-320-396-20M	397	UM-STAR-NB	436
UA-B0-311256-20M	360	UA-HEXI-60	398	UA-LIND-352-796-01	397	UM-STAR-RZ	436
UA-B0-311288	360	UA-HEXI96-01	398	UA-LIND-352-796-05	397	UM-STAR-ZT	436
UA-B0-311288-20M*	360	UA-HEXI96-05	398	UA-LIND-352-796-18	397	UM-TWITT-SZ	436
UA-B0-311320	360	UA-HEXI96-10M	398	UA-LIND-352-796-20M	397	UM-TWITT-ZL	436
UA-B0-311320-20M	360	UA-HEXI96-18	398	UA-PICADO-224-496-01	402	UM-UNICORN-RZ	439
UA-B0-311480	360	UA-HEXI96-20M	398	UA-PICADO-224-496-05	402	UP-WP0728-BB	416
UA-B0-311480-20M*	360	UA-HEXI96-60	398	UA-PICADO-224-496-18	402	UP-WP0728-BK	416
UA-B0-337128	361	UA-HEXI-128-01	398	UA-PICADO-224-496-20M	402	UP-WP0728-BR	416
UA-B0-337160	361	UA-HEXI-128-05	398	UA-PICADO-256-296-01	402	UP-WP0728-BX	416

UP-WP0728-P0	417	UZ-336128-06	359	UZ-BAGIO-192-90	346	UZ-CAPRI-320-02	344
UP-WP0728-PA-04	417	UZ-336160-06	359	UZ-BAGIO-320-01	346	UZ-CAPRI-320-05	344
UP-WP0728-PA-07	417	UZ-336192-06	359	UZ-BAGIO-320-04	346	UZ-CAPRI-320-06	344
UP-WP0728-PB	417	UZ-336256-06	359	UZ-BAGIO-320-05	346	UZ-CLEO-128-01	364
UP-WP0728-PC-04	417	UZ-336320-06	359	UZ-BAGIO-320-06	346	UZ-CLEO-128-05	364
UP-WP0728-PK	417	UZ-336416-06	359	UZ-BAGIO-320-07	346	UZ-CLEO-128-06	364
UP-WP0728-PR	417	UZ-336480-06	359	UZ-BAGIO-320-11	346	UZ-CLEO-160-01	364
UP-WP0728-PX	417	UZ-682128-06	359	UZ-BAGIO-320-15	346	UZ-CLEO-160-05	364
UZ-00B224-01	395	UZ-682160-06	359	UZ-BAGIO-320-20M	346	UZ-CLEO-160-06	364
UZ-00B224-02	395	UZ-682192-06	359	UZ-BAGIO-320-90	346	UZ-CLEO-192-01	364
UZ-00B224-05	395	UZ-682224-06	359	UZ-CALABRIA160-01	383	UZ-CLEO-192-05	364
UZ-00B224-10	395	UZ-682256-06	359	UZ-CALABRIA160-06	383	UZ-CLEO-192-06	364
UZ-00B224-20	395	UZ-682320-06	359	UZ-CALABRIA192-01	383	UZ-CRA14-128	432
UZ-00B226-01	396	UZ-682416-06	359	UZ-CALABRIA192-06	383	UZ-CRA14-192	432
UZ-00B226-02	396	UZ-682480-06	359	UZ-CALABRIA224-01	383	UZ-CRA14-320	432
UZ-00B226-05	396	UZ-ABIAT-128-04	427	UZ-CALABRIA224-06	383	UZ-E6-096-01	394
UZ-00B226-10	396	UZ-ACERA-96-04	428	UZ-CAMAI-96-01	376	UZ-E6-096-05	394
UZ-00B226-20	396	UZ-ADRIN-96-04	427	UZ-CAMAI-96-02	376	UZ-E6-096-06	394
UZ-01-096-01	384	UZ-ALATR-128-04	417	UZ-CAMAI-96-06	376	UZ-E6-128-01	394
UZ-01-096-02	384	UZ-ANCON-128-01	363	UZ-CAMAI-96-09	376	UZ-E6-128-05	394
UZ-01-096-05	384	UZ-ANCON-128-05	363	UZ-CAMAI-96-10M	376	UZ-E6-128-06	394
UZ-01-128-01	384	UZ-ANCON-128-06	363	UZ-CAMAI-96-12	376	UZ-E6-160-01	394
UZ-01-128-02	384	UZ-ANCON-192-01	363	UZ-CAMAI-96-20M	376	UZ-E6-160-05	394
UZ-01-128-05	384	UZ-ANCON-192-05	363	UZ-CAMAI-96-90	376	UZ-E6-160-06	394
UZ-05-096-01	384	UZ-ANCON-192-06	363	UZ-CAMAI-128-01	376	UZ-EVER-128-20M	371
UZ-05-096-02	384	UZ-ANCON-256-01	363	UZ-CAMAI-128-02	376	UZ-EVER-128-90	371
UZ-05-096-05	384	UZ-ANCON-256-05	363	UZ-CAMAI-128-06	376	UZ-FABRICIO-128-03	367
UZ-05-128-01	384	UZ-ANCON-256-06	363	UZ-CAMAI-128-09	376	UZ-FABRICIO-128-18	367
UZ-05-128-02	384	UZ-ARCH096-AEB	426	UZ-CAMAI-128-10M	376	UZ-FABRICIO-128-20M	367
UZ-05-128-05	384	UZ-ARDEA-96-09	425	UZ-CAMAI-128-12	376	UZ-FABRICIO-192-03	367
UZ-06-128-01	386	UZ-AREZO-96-04	426	UZ-CAMAI-128-20M	376	UZ-FABRICIO-192-18	367
UZ-06-128-02	386	UZ-BAGIO-128-01	346	UZ-CAMAI-128-90	376	UZ-FABRICIO-192-20M	367
UZ-06-128-05	386	UZ-BAGIO-128-04	346	UZ-CAPRI-96-01	344	UZ-FABRICIO-320-03	367
UZ-07-096-01	386	UZ-BAGIO-128-05	346	UZ-CAPRI-96-02	344	UZ-FABRICIO-320-18	367
UZ-07-096-02	386	UZ-BAGIO-128-06	346	UZ-CAPRI-96-05	344	UZ-FABRICIO-320-20M	367
UZ-07-096-05	386	UZ-BAGIO-128-07	346	UZ-CAPRI-96-06	344	UZ-FIORD-32-03	403
UZ-12-096-04	420	UZ-BAGIO-128-11	346	UZ-CAPRI-128-01	344	UZ-FIORD-32-05	403
UZ-12-096-04N	420	UZ-BAGIO-128-15	346	UZ-CAPRI-128-02	344	UZ-FIORD-32-06	403
UZ-12-096-20M	420	UZ-BAGIO-128-20M	346	UZ-CAPRI-128-05	344	UZ-FIORD-32-10	403
UZ-13-096-01	387	UZ-BAGIO-128-90	346	UZ-CAPRI-128-06	344	UZ-FIORD-32-16	403
UZ-13-096-02	387	UZ-BAGIO-160-01	346	UZ-CAPRI-128-20M	344	UZ-FIORD-32-18	403
UZ-13-096-05	387	UZ-BAGIO-160-04	346	UZ-CAPRI-160-01	344	UZ-FIORD-32-20M	403
UZ-40-032-01	357	UZ-BAGIO-160-05	346	UZ-CAPRI-160-02	344	UZ-FLAVIO-96-01	350
UZ-40-032-02	357	UZ-BAGIO-160-06	346	UZ-CAPRI-160-05	344	UZ-FLAVIO-96-03	350
UZ-40-032-05	357	UZ-BAGIO-160-07	346	UZ-CAPRI-160-06	344	UZ-FLAVIO-96-06	350
UZ-40-032-06	357	UZ-BAGIO-160-11	346	UZ-CAPRI-160-20M	344	UZ-FLAVIO-96-16	350
UZ-40-032-20M	357	UZ-BAGIO-160-15	346	UZ-CAPRI-192-01	344	UZ-FLAVIO-96-20M	350
UZ-133128-01	355	UZ-BAGIO-160-20M	346	UZ-CAPRI-192-02	344	UZ-FLAVIO-128-01	350
UZ-133128-02	355	UZ-BAGIO-160-90	346	UZ-CAPRI-192-05	344	UZ-FLAVIO-128-03	350
UZ-133128-05	355	UZ-BAGIO-192-01	346	UZ-CAPRI-192-06	344	UZ-FLAVIO-128-06	350
UZ-133128-06	355	UZ-BAGIO-192-04	346	UZ-CAPRI-192-20M	344	UZ-FLAVIO-128-16	350
UZ-133128-20M	355	UZ-BAGIO-192-05	346	UZ-CAPRI-256-01	344	UZ-FLAVIO-128-20M	350
UZ-334128-06	358	UZ-BAGIO-192-06	346	UZ-CAPRI-256-02	344	UZ-FLAVIO-160-01	350
UZ-334160-06	358	UZ-BAGIO-192-07	346	UZ-CAPRI-256-05	344	UZ-FLAVIO-160-03	350
UZ-334192-06	358	UZ-BAGIO-192-11	346	UZ-CAPRI-256-06	344	UZ-FLAVIO-160-06	350
UZ-334256-06	358	UZ-BAGIO-192-15	346	UZ-CAPRI-256-20M	344	UZ-FLAVIO-160-16	350
UZ-334320-06	358	UZ-BAGIO-192-20M	346	UZ-CAPRI-320-01	344	UZ-FLAVIO-160-20M	350

UZ-FLAVIO-192-03	350	UZ-G2-224-01	353	UZ-NORD-160-18	364	UZ-VASTO-128-09	422
UZ-FLAVIO-192-06	350	UZ-G2-224-06	353	UZ-NORD-160-20M	364	UZ-VENICE-128-20M	366
UZ-FLAVIO-192-16	350	UZ-G2-224-20M	353	UZ-NORD-192-03	364	UZ-VENICE-128-90	366
UZ-FLAVIO-192-20M	350	UZ-GENUA128-01	383	UZ-NORD-192-18	364	UZ-VITO-160-01	347
UZ-FLAVIO-320-03	350	UZ-GENUA128-02	383	UZ-NORD-192-20M	364	UZ-VITO-160-05	347
UZ-FLAVIO-320-06	350	UZ-GENUA128-05	383	UZ-NORD-320-03	364	UZ-VITO-160-07	347
UZ-FLAVIO-320-16	350	UZ-GENUA128-20M	383	UZ-NORD-320-18	364	UZ-VITO-160-12	347
UZ-FLAVIO-320-20M	350	UZ-GENUA160-01	383	UZ-NORD-320-20M	364	UZ-VITO-160-16	347
UZ-FLOW-128-06	369	UZ-GENUA160-02	383	UZ-OCTAVIO-128-01	342	UZ-VITO-160-20M	347
UZ-FLOW-128-20M	369	UZ-GENUA160-05	383	UZ-OCTAVIO-128-06	342	UZ-VITO-288-01	347
UZ-FLOW-128-90	369	UZ-GENUA160-20M	383	UZ-OCTAVIO-128-18	342	UZ-VITO-288-05	347
UZ-FLOW-192-06	369	UZ-MARSA-64-07	419	UZ-OCTAVIO-128-20M	342	UZ-VITO-288-07	347
UZ-FLOW-192-20M	369	UZ-MARSA-64-09	419	UZ-OCTAVIO-160-01	342	UZ-VITO-288-12	347
UZ-FLOW-192-90	369	UZ-MARSA-64-10M	419	UZ-OCTAVIO-160-06	342	UZ-VITO-288-16	347
UZ-G0-128-01	380	UZ-MARSA-64-11	419	UZ-OCTAVIO-160-18	342	UZ-VITO-288-20M	347
UZ-G0-128-05	380	UZ-MARSA-64-15	419	UZ-OCTAVIO-160-20M	342	UZ-WERON-96-04	425
UZ-G0-128-06	380	UZ-MARSA-64-18	419	UZ-OCTAVIO-192-01	342	UZ-WERON-96-09	425
UZ-G0-160-01	380	UZ-MARSA-64-20M	419	UZ-OCTAVIO-192-06	342	UZ-WERON-96-12	425
UZ-G0-160-05	380	UZ-MILAN-128-01	354	UZ-OCTAVIO-192-18	342	UZ-WERON-128-04	425
UZ-G0-160-06	380	UZ-MILAN-128-05	354	UZ-OCTAVIO-192-20M	342	UZ-WERON-128-09	425
UZ-G0-192-01	380	UZ-MILAN-128-06	354	UZ-OLBIA-96-04	424	UZ-WERON-128-12	425
UZ-G0-192-05	380	UZ-MILAN-128-20M	354	UZ-OLBIA-128-04	424	UZ-WP1146-04	430
UZ-G0-192-06	380	UZ-MILAN-256-01	354	UZ-OTTO-128-06	370	UZ-Z10096-01	387
UZ-G0-256-01	380	UZ-MILAN-256-05	354	UZ-OTTO-128-20M	370	UZ-Z10096-02	387
UZ-G0-256-05	380	UZ-MILAN-256-06	354	UZ-OTTO-128-90	370	UZ-Z10096-05	387
UZ-G0-256-06	380	UZ-MILAN-256-20M	354	UZ-OTTO-160-06	370	UZ-Z10096-20M	387
UZ-G1-128-01	380	UZ-MODEN-128-01	356	UZ-OTTO-160-20M	370	UZ-Z10128-01	387
UZ-G1-128-05	380	UZ-MODEN-128-05	356	UZ-OTTO-160-90	370	UZ-Z10128-02	387
UZ-G1-128-06	380	UZ-MODEN-128-06	356	UZ-PALER-96-07	424	UZ-Z10128-05	387
UZ-G1-128-13	380	UZ-MODEN-128-20M	356	UZ-PALER-128-07	424	UZ-Z10128-20M	387
UZ-G1-128-20M	380	UZ-MODEN-160-01	356	UZ-REN096-04A	428		
UZ-G1-160-01	380	UZ-MODEN-160-05	356	UZ-RETRIS-128-04	418	<b>W</b>	
UZ-G1-160-05	380	UZ-MODEN-160-06	356	UZ-RETRIS-128-07	418	WA-MALAG-A0-01	448
UZ-G1-160-06	380	UZ-MODEN-160-20M	356	UZ-RETRIS-128-20M	418	WA-MALAG-A0-02	448
UZ-G1-160-13	380	UZ-MODEN-192-01	356	UZ-ROYAL1-96-10-03	429	WA-MALAG-A0-05	448
UZ-G1-160-20M	380	UZ-MODEN-192-05	356	UZ-ROYAL2-96-10-03	429	WA-MALAG-A0-20	448
UZ-G1-192-01	380	UZ-MODEN-192-06	356	UZ-ROYAL3-96-10-03	429	WA-MALAG-B0-01	449
UZ-G1-192-05	380	UZ-MODEN-192-20M	356	UZ-ROYAL4-96-03	429	WA-MALAG-B0-02	449
UZ-G1-192-06	380	UZ-MONA-128-01-10	351	UZ-ROYAL5-96-10-03	429	WA-MALAG-B0-05	449
UZ-G1-192-13	380	UZ-MONA-128-01-20	351	UZ-ROYAL5-128-10-03	429	WA-MALAG-B0-20	449
UZ-G1-192-20M	380	UZ-MONA-192-01-10	351	UZ-STEP-160-07	374	WB-073024-01	235
UZ-G1-256-01	380	UZ-MONA-192-01-20	351	UZ-STEP-160-20M	374	WB-073024-06	235
UZ-G1-256-05	380	UZ-MONA-256-01-10	351	UZ-TH096128-01	362	WB-073025-01	236
UZ-G1-256-06	380	UZ-MONA-256-01-20	351	UZ-TH096128-05	362	WB-073025-06	236
UZ-G1-256-13	380	UZ-MONZA160-06	351	UZ-TH096128-06	362	WB-073026-01	236
UZ-G1-256-20M	380	UZ-MONZA160-10	351	UZ-TH160192-01	362	WB-073026-06	236
UZ-G1-320-01	380	UZ-MONZA160-20	351	UZ-TH160192-05	362	WB-WS-12-010	237
UZ-G1-320-05	380	UZ-MONZA256-06	351	UZ-TH160192-06	362	WB-WS-18-010	237
UZ-G1-320-06	380	UZ-MONZA256-10	351	UZ-TH288320-01	362	WB-WS-18-020	237
UZ-G1-320-13	380	UZ-MONZA256-20	351	UZ-TH288320-06	362	WB-WS-18-060	237
UZ-G1-320-20M	380	UZ-MONZA384-06	351	UZ-TIVOL-192-01	363	WB-WS-24-010	238
UZ-G1-416-01	380	UZ-MONZA384-10	351	UZ-TIVOL-192-12	363	WB-WS-24-020	238
UZ-G1-416-05	380	UZ-MONZA384-20	351	UZ-TIVOL-192-13	363	W-CUSTOMI-60L450	218
UZ-G1-416-06	380	UZ-NORD-128-03	364	UZ-TIVOL-320-01	363	W-CUSTOMI-60L500	218
UZ-G2-160-01	353	UZ-NORD-128-18	364	UZ-TIVOL-320-12	363	W-CUSTOMI-80L450	219
UZ-G2-160-06	353	UZ-NORD-128-20M	364	UZ-TIVOL-320-13	363	W-CUSTOMI-80L500	219
UZ-G2-160-20M	353	UZ-NORD-160-03	364	UZ-VASTO-96-09	422	WG-KOSZ60-10	271

WG-KOSZ60-60	271	WG-WSPOD60-60	276	W-WK080-BP-60	284	WZ-A0-K24-05	447
WG-KOSZ70-10	271	WG-WSPOD70	276	W-WK090-BP-10	285	WZ-A0-K24-07	447
WG-KOSZ70-60	271	WG-WSPOD70-10	276	W-WK090-BP-60	284	WZ-A0-K24-20	447
WG-KOSZ80-10	271	WG-WSPOD70-60	276	W-WKRP-BP-10	286	WZ-B0-K23-01	446
WG-KOSZ80-60	271	WG-WSPOD80	276	W-WKRP-BP-60	286	WZ-B0-K23-02	446
WG-KOSZ90-10	271	WG-WSPOD80-10	276	W-WKRP-VE-10	286	WZ-B0-K23-03	446
WG-KOSZ90-60	271	WG-WSPOD80-60	276	W-WKRP-VE-60	286	WZ-B0-K23-04	446
WG-KOSZM60-10	270	WG-WSPOD90	276	W-WOBU60-BP-10	281	WZ-B0-K23-05	446
WG-KOSZM60-60	270	WG-WSPOD90-10	276	W-WOBU60-BP-60	280	WZ-B0-K23-06	446
WG-KOSZM70-10	270	WG-WSPOD90-60	276	W-WOBU70-BP-10	281	WZ-B0-K23-07	446
WG-KOSZM70-60	270	WK-CAM-15-12-D	248	W-WOBU70-BP-60	280	WZ-B0-K23-20	446
WG-KOSZM80-10	270	WK-CAM-15-13-D	248	W-WOBU80-BP-10	281	WZ-B0-K24-01	447
WG-KOSZM80-60	270	WK-CAM-15-DOW63X31-KPL-1T		W-WOBU80-BP-60	280	WZ-B0-K24-02	447
WG-KOSZM90-10	270		249	W-WOBU90-BP-10	281	WZ-B0-K24-03	447
WG-KOSZM90-60	270	WK-CAM-15-DOW63X35-KPL-1T		W-WOBU90-BP-60	280	WZ-B0-K24-04	447
WG-KOSZR60-10	272		249	W-WSPD60-BP-10	283	WZ-B0-K24-05	447
WG-KOSZR60-60	272	WK-CAM-15-DOW63X39-KPL-1T		W-WSPD60-BP-60	282	WZ-B0-K24-07	447
WG-KOSZR70-10	272		249	W-WSPD70-BP-10	283	WZ-B0-K24-20	447
WG-KOSZR70-60	272	WK-CAM-15-DOW63X45-KPL-1T		W-WSPD70-BP-60	282	WZ-C0-K24-01	448
WG-KOSZR80-10	272		249	W-WSPD80-BP-10	283	WZ-C0-K24-02	448
WG-KOSZR80-60	272	WK-CF0750-01	249	W-WSPD80-BP-60	282	WZ-C0-K24-03	448
WG-KOSZR90-10	272	WK-CF6450-01	249	W-WSPD90-BP-10	283	WZ-C0-K24-04	448
WG-KOSZR90-60	272	WK-D0320-001*	247	W-WSPD90-BP-60	282	WZ-C0-K24-05	448
WG-POBUW60-10	273	WK-D0325-001*	247	WW-WSD250-01B	290	WZ-C0-K24-20	448
WG-POBUW60-60	273	WK-D0330-001*	247	WW-WSD300-01B	290	WZ-CAPITAL-18	444
WG-POBUW70-10	273	WK-D0416-001	247	WW-WSD350-01B	290	WZ-CAPITAL-20M	444
WG-POBUW70-60	273	WK-D0425-001*	247	WW-WSD400-01B	290	WZ-CORDOBA-01	442
WG-POBUW80-10	273	WK-D0430-001	247	WW-WSD450-01B	290	WZ-CORDOBA-06	442
WG-POBUW80-60	273	WK-D0440-001	247	WW-WSD500-01B	290	WZ-CORDOBA-20M	442
WG-POBUW90-10	273	WK-D0460-001	247	WW-WSL250-01	289	WZ-CORUNA-D-04	450
WG-POBUW90-60	273	WK-D3516-001	247	WW-WSL300-01	289	WZ-CORUNA-D-07	450
WG-POBUWM60-10	274	WK-D3530-001	247	WW-WSL350-01	289	WZ-CORUNA-D-17	450
WG-POBUWM60-60	274	WK-DOW63X316-D	248	WW-WSL400-01	289	WZ-CORUNA-D-20M	450
WG-POBUWM70-10	274	WK-DOW63X35B-D	248	WW-WSL450-01	289	WZ-CORUNA-M-04	451
WG-POBUWM70-60	274	WK-DOW63X39-D	248	WW-WSL500-01	289	WZ-CORUNA-M-07	451
WG-POBUWM80-10	274	WK-DOW63X45B-D	248	WW-WSL000-01	288	WZ-CORUNA-M-17	451
WG-POBUWM80-60	274	WK-SZ-AS-400-10	220	WW-WSP000-01	288	WZ-CORUNA-M-20M	451
WG-POBUWM90-10	274	WK-SZ-AS-400-60	220	WW-WSP00-01	288	WZ-CRAFT-04	453
WG-POBUWM90-60	274	WK-SZ-AS-500-10	220	WW-WUBR00-01	289	WZ-CRAFT-07	453
WG-PRZEG60-10	275	WK-SZ-AS-500-60	220	WW-ZWBUT2P-10	290	WZ-CRAFT-15	453
WG-PRZEG60-60	275	WK-SZ-AS-600-10	220	WW-ZWBUT2P-20	290	WZ-CRAFT-20M	453
WG-PRZEG70-10	275	WK-SZ-AS-600-60	220	WZ-00-K24-04	454	WZ-E-018-01	450
WG-PRZEG70-60	275	WK-SZ-AS-800-10	220	WZ-804-20-01	444	WZ-E-018-02	450
WG-PRZEG80-10	275	WK-SZ-AS-800-60	220	WZ-804-20-05	444	WZ-E-018-05	450
WG-PRZEG80-60	275	WK-SZ-AS-900-10	220	WZ-804-20-06	444	WZ-E-018-06	450
WG-PRZEG90-10	275	WK-SZ-AS-900-60	220	WZ-A0-K23-01	446	WZ-E-018-20M	450
WG-PRZEG90-60	275	WM-BALL-CZ-B	455	WZ-A0-K23-02	446	WZ-K2201-01	443
WG-RDRO-10	277	WM-BLOCK-NB	455	WZ-A0-K23-03	446	WZ-K2201-06	443
WG-RDRO-60	277	WM-BLOCK-ZL	455	WZ-A0-K23-04	446	WZ-K2201-CZ	443
WG-RDRP-10	277	WM-CLOUD-NB	455	WZ-A0-K23-05	446	WZ-K2202-01	443
WG-RDRP-60	277	WM-CLOUD-SZ	455	WZ-A0-K23-06	446	WZ-K2202-06	443
WG-RRPSET-A-10	277	WM-UNICORN-RZ	455	WZ-A0-K23-07	446	WZ-K2202-CZ	443
WG-RRPSET-A-60	277	W-WK060-BP-10	285	WZ-A0-K23-20	446	WZ-MADRYT-04	452
WG-RRPSET-B-10	277	W-WK060-BP-60	284	WZ-A0-K24-01	447	WZ-MADRYT-07	452
WG-RRPSET-B-60	277	W-WK070-BP-10	285	WZ-A0-K24-02	447	WZ-MADRYT-15	452
WG-WSPOD60	276	W-WK070-BP-60	284	WZ-A0-K24-03	447	WZ-MADRYT-20M	452
WG-WSPOD60-10	276	W-WK080-BP-10	285	WZ-A0-K24-04	447	WZ-MALAG-C0-01	449



WZ-MALAG-C0-02	449	ZM-DCHC09-3DZEO	71	ZIP-BICJ090ZE-B	90	ZIP-CONL08-BE	87
WZ-MALAG-C0-05	449	ZM-ECHC07-3DBEO	77	ZIP-BICJ270ZE-B	91	ZIP-CONL08-ZE	87
WZ-MALAG-C0-20	449	ZM-ECHC07BEO	74	ZIP-BICJ280ZE-B	90	ZIP-CONL09-BE	87
WZ-ORVIE-A0-09	453	ZM-ECHC07H04-BE	76	ZIP-BICJ290ZE-B	90	ZIP-CONL09-ZE	87
WZ-SCTYLPR-BWK	242	ZM-ECHC07ZEO	74	ZIP-BICN070BEO	89	ZIP-JUNIOR-00	105
WZ-SCTYLPR-WK	242	ZM-ECHC08-3DBEO	77	ZIP-BICN070ZEO	89	ZIP-KT30H2-BE	92
WZ-TOLED-A0-01	440	ZM-ECHC08BEO	74	ZIP-BICN072BEO	89	ZIP-KT45H2-ZE	92
WZ-TOLED-A0-02	440	ZM-ECHC08H04-BE	75	ZIP-BICN072ZEO	89	ZIP-KT90H2-BE	93
WZ-TOLED-A0-05	440	ZM-ECHC08ZEO	74	ZIP-BICN080BEO	89	ZIP-KT90H2-ZE	93
WZ-TOLED-A0-06	440	ZM-ECHC09-3DBEO	76	ZIP-BICN080ZEO	89	ZIP-KT135H2BE	94
WZ-TOLED-A0-20M	440	ZM-ECHC09BEO	73	ZIP-BICN082BEO	89	ZIP-KT135H2ZE	94
WZ-TOLED-B0-01	440	ZM-ECHC09H04-BE	75	ZIP-BICN082ZEO	89	ZIP-KT165H2BE	94
WZ-TOLED-B0-02	440	ZM-ECHC09ZEO	73	ZIP-BICN090BEO	88	ZIP-KT165H2ZE	94
WZ-TOLED-B0-05	440	ZM-HCKT30-BE-S	81	ZIP-BICN090ZEO	88	ZIP-KT0270-BE	104
WZ-TOLED-B0-06	440	ZM-HCKT30-ZE-S	81	ZIP-BICN092BEO	88	ZIP-KTK90H6BE	93
WZ-TOLED-B0-20M	440	ZM-HCKT45-3DBEO-S	82	ZIP-BICN092ZEO	88	ZIP-KTK90H6ZE	93
WZ-TOLED-C0-01	441	ZM-HCKT45-BE-S	81	ZIP-BIDI07-3DBEO	86	ZIP-P07H045BE	98
WZ-TOLED-C0-02	441	ZM-HCKT45-ZE-S	81	ZIP-BIDI08-3DBEO	86	ZIP-POH045BEO	98
WZ-TOLED-C0-05	441	ZM-HCKT90-3DBEO-S	83	ZIP-BIDI09-3DBEO	85	ZIP-POH045ZEO	98
WZ-TOLED-C0-06	441	ZM-HCKT90-BE-S	82	ZIP-CIBI7H0ZE	101	ZIP-RALUH2-00	103
WZ-TOLED-C0-20M	441	ZM-HCKT90-ZE-S	82	ZIP-CIBI8H0ZE	101	ZIP-SKR-00-80	106
WZ-WALENCIA-01	442	ZM-HCKT155BE	84	ZIP-CIBI9H0ZE	100	ZT-HF-01-D00	104, 105
WZ-WALENCIA-06	442	ZM-HCKT155ZE	84	ZIP-CIG-070ZE	102	ZZ-16-103-01-S	329
WZ-WALENCIA-20M	442	ZM-HCKT165-3DBEO-S	85	ZIP-CIG-07UZE	102	ZZ-20-103-01-S	329
		ZM-HCKT165BE-S	84	ZIP-CIG-090ZE	102	ZZ-30-103-01-S	329
		ZM-HCKT165ZE-S	84	ZIP-CIG-09UBE	102	ZZ-B0-105-01-S	328
ZC-GTV-12-00	106	ZM-HCKTK90-ZE	83	ZIP-CIG-09UZE	102	ZZ-BA-SK0-01-S	331
ZC-GTV-14-00	106	ZM-HCRALU9BE	103	ZIP-CIG-09UZE	102	ZZ-BA-SK0-PR	331
ZK-FORCE-KPL	243	ZM-HCSL07-3D	70	ZIP-CIG-170ZE	102	ZZ-C1-288-01-S	332
ZK-FORZA-ZAS-KPL-010	245	ZM-HCSL08-3D	70	ZIP-CIG-17UZE	102	ZZ-C5-288-01-S	332
ZK-FORZA-ZAS-KPL-020	245	ZM-HCSL09-3D	69	ZIP-CIG-190ZE	102	ZZ-C6-288-01-S	332
ZK-FORZA-ZAW-KPL	244	ZM-INHC070BEO	80	ZIP-CIG-19UZE	102	ZZ-C8-288-01-S	332
ZK-R1-KPL-10	244	ZM-INHC070ZEO	80	ZIP-CIHC070ZE	100	ZZ-CF-138-01	327
ZK-ZAW-R0-10	243	ZM-INHC080BEO	80	ZIP-CIHC080ZE	99	ZZ-G0-328-01	331
ZK-ZAW-R0-30	243	ZM-INHC080ZEO	80	ZIP-CIHC090ZE	99	ZZ-KLMASTER	327
ZM-CNHC07BR2	79	ZM-INHC090BEO	79	ZIP-COCA450-BE	95	ZZ-KM-138-01-S	326
ZM-CNHC08BR2	78	ZM-INHC090ZEO	79	ZIP-COCA450-BE-F	96	ZZ-M0-201-01-S	330
ZM-CNHC09BR2	78	ZM-KT45H2-BE	92	ZIP-COCA450-ZE	95	ZZ-SP-105-05	332, 539
ZM-COVERHCSL-SET	71	ZM-OT-Standard	69	ZIP-COCA7450-BE	96	ZZ-SP-KLMASTER	332
ZM-DCHC07-3DBEO	72	ZM-SZABLON-ZAW	107	ZIP-COCA7450-BE-F	97	ZZ-SZ-409-01-S	329
ZM-DCHC07-3DZEO	72	ZN-OT-heavy	69	ZIP-COCA8450-BE	95	ZZ-Z0-202-01-S	330
ZM-DCHC08-3DBEO	72	Z-OGR-KAT91		ZIP-COCA8450-BE-F	97	ZZ-ZN-138-01	326
ZM-DCHC08-3DZEO	72	ZIP-BICJ070ZE-B	91	ZIP-CONL07-BE	88	ZZ-ZN-338-01-S	328
ZM-DCHC09-3DBEO	71	ZIP-BICJ080ZE-B	90	ZIP-CONL07-ZE	88		

## Z



Tento produktový katalog byl vyhotoven společností GTV Polsko. Neustálým vylepšováním kvality produktů s ohledem na tržní trendy a respektem na zákonodárné úpravy si společnost GTV vyhrazuje právo na změny v prezentované produktové nabídce. Aktuální produktová nabídka není nabídkou ve smyslu občanského zákoníku. Skutečné produkty se mohou lišit od vyobrazení a nákresech v katalogu. GTV si vyhrazuje právo na změny a neručí za případné tiskové chyby.

Tento produktový katalog bol vyhotovený spoločnosťou GTV Poland. Neustálym zlepšováním svojej ponuky v súlade s požiadavkami trhu a zákonov si GTV Poland vyhradzuje právo vykonávať zmeny v uvedenom sortimente. Predkladaná publikácia nie je ponukou v zmysle Občianskeho zákonníka. Skutočné výrobky sa môžu líšiť od ukážkových fotografií a výkresov v publikácii. GTV Poland si vyhradzuje právo na zmeny a tlačové chyby.

Ezt a termékkatalógust a GTV Poland készítette. A GTV Lengyelország folyamatosan fejleszti termékeit, hogy megfeleljen a piaci és jogszabályi követelményeknek. Jelen kiadvány nem minősül ajánlattételnek a Polgári Törvénykönyv értelmében. A valódi termékek eltérhetnek a kiadványban szereplő példafotóktól és rajzoktól. A GTV Poland fenntartja a változtatások és nyomtatási hibák jogát.

Acest catalog de produse a fost pregătit de GTV Polonia. În scopul de a îmbunătăți constant produsele și pentru a respecta cerințele legale și de piață, GTV Polonia își rezervă dreptul de a introduce modificări în gama de produse prezentată. Prezentă publicație nu constituie o ofertă în sensul Codului civil. Produsele reale pot diferi de exemplele de fotografii și desene din publicație. GTV Polonia își rezervă dreptul de a efectua modificări și erori de tipărire.



# GTV

ul. Przejazdowa 21  
05-800 Pruszków  
Poland

 +48 22 44 47 272

 +48 22 44 47 366  
+48 22 44 47 331

 +48 22 44 47 391

 +48 22 44 47 379

 +420 591 160 091

 +48 22 4447 523

 +375 291 504 626  
+48 22 4447 529

 +48 22 4447 216  
+48 22 4447 586

 +48 22 4447 525

 +48 22 4447 301  
+48 22 4447 586

 tel: 8-495-640 15 88

 GTV Croatia d.o.o  
Roberta Frangeša Mihanovića 9  
10110 Zagreb  
+ 385 1 798 8089

 GTV Czech Distribution s.r.o.  
CTPark Ostrava, Na Rovince 879  
720 00 Ostrava-Hrabová  
Česká republika  
+420 591 160 092  
+420 727 800 362  
+420 725 715 142

 GTV España Herrajes e Iluminación,  
S.L., Avenida Aragón 30, Planta 8  
46021 Valencia (España)  
+ 34 960 468 666  
+ 48 22 444 73 77

fax: +48 22 444 75 01  
e-mail: [info@gtv.com.pl](mailto:info@gtv.com.pl)  
[www.gtv.com.pl](http://www.gtv.com.pl)

